



PROFILPREISLISTE 2014/15

für Boden- und Wandprofile
Werkzeuge und Unterlagsmatten











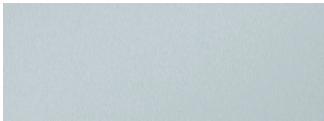

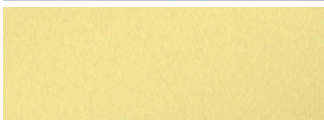



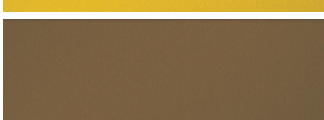



PROFILE PRICELIST 2014/15



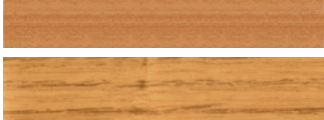



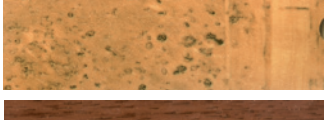







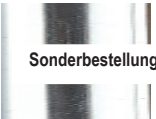
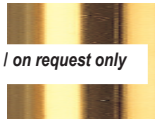







*for floor and wall profiles
tools and underlays*

FARBTABELLE COLOUR CARD

für PROFILE / for PROFILES

PAFUDIMA

	silber silver	für Ahorn, Kiefer und Esche for maple, pine, ash-tree	
	sand sand	für Buche, Kirsche for beech, cherry	
	gold gold	für Eiche for oak	
	bronze bronze	für Eiche dunkel for dark oak	
	Edelstahl optik stainless steel optic	für Mahagoni, Acayou for mahogany, acayou	
	Buche hell 10 light beech	für Merbau, Doussie for merbau, doussie	
	Buche dunkel 11 dark beech	für Wenge, Räuchereiche for wenge, smoked oak	
	Eiche 12 oak	für Nuss, Teak for walnut, teak	
	Esche 13 ash tree		
	Ahorn 14 maple		
	Kork 16 cork		
	Merbau 17 merbau		
	Kirsche 18 cherry		
	Walnuss 19 walnut		

für FLIESENPROFILE for CERAMIC TILES			
			
S = Alu silber / alu silver R = Alu roh / alu raw	G = Alu gold / alu gold	B = Alu bronze / alu bronze	SD = Alu sand / alu sand
Sonderbestellung / on request only			
			
ASB = Alu chrom glänzend / alu chemical polished	AOB = Alu gold brilliant / alu gold brilliant	M = Messing / brass	E = Edelstahl / stainless steel EO = Edelstahloptik / stainless steel optic
ALU pulverbeschichtet / alu coated			
			
BH = bahama beige BH = bahama beige	MH = manhattan MH = manhattan	KR = krokus KR = crocus	BB = bläss beige BB = light beige
			
W = weiß W = white			
Kunststoff / synthetic			
			
11 weiß 11 white	21 manhattan 21 manhattan	31 hell beige 31 light beige	32 dunkel beige 32 dark beige
			
41 creme 41 creme	43 pfirsich 43 apricot	44 magnolie 44 magnolia	45 krokus 45 crocus



STARKE PROFILE - STARKE IDEEN
GREAT PROFILES - GREAT IDEAS



KÜGELE PROFILE GmbH

1100 Wien

AUSTRIA

Favoritner Gewerbering 1 Objekt B

FN 256402m

Handelsgericht Wien

Telefon : +43 (1) 601 79 - 0

Fax: + 43 (1) 601 79 – 70

orders@kuegele.com

www.kuegele.com

KÜGELE Deutschland

M. A. Kügele GmbH

DEUTSCHLAND / GERMANY

85764 Oberschleißheim

Mittenheimerstrasse 66

Tel.: +49 (0) 89 - 37 55 999 4

Fax.: +49 (0) 89 - 37 55 9 666

schauraum@kuegele.de



ÖSTERREICH:

MAILADRESSEN

TELEFON

FAX

Geschäftsleitung

gl@kuegele.com

0

32

Verkaufsleitung

vkl@kuegele.com

14

32

Buchhaltung

buchhaltung@kuegele.com

33

32

Export

export@kuegele.com

26

80

Verkauf Österreich

orders@kuegele.com

40

32

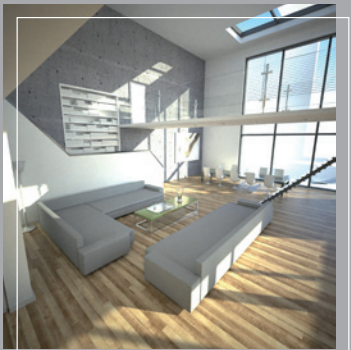

Hinweise zu unserer Preisliste:
Terms and conditions price list:

Preis:	Gültig ab 1. Oktober 2014 - Letztverbraucherpreise in EURO inkl. MwSt. Alle früheren Preise und Sondervereinbarungen werden mit diesem Termin ungültig! Unsere Preise sind auf der augenblicklichen Kostenbasis (Materialkosten etc.) erstellt. Sollte sich die Basis ändern, behalten wir uns die Verrechnung eines Teuerungszuschlages = TZ ausdrücklich vor.
<i>Price:</i>	<i>Valid with effect from 1. October 2014 - All prices are in EURO retail prices incl. VAT. These Terms and Conditions supercede all previous prices and conditions. Our prices are based in current raw material and other costs. Should there be a change in raw material or other costs, we reserve the right to adjust the prices.</i>
Händlerkonditionen:	Nach Abzug der Händlerkonditionen (-50% auf die Verkaufspreise inkl. MwSt.) ergibt sich ein Nettopreis ohne MwSt.
<i>Sales conditions:</i>	<i>On these prices we grant you a whole sale discount of - 50% (net without VAT).</i>
Zahlungskonditionen:	Die ersten 3 Aufträge nur gegen Vorkasse abzgl. 4% Skonto. Folgeaufträge: 10 Tage 3% Skonto, 30 Tage netto. Bankeinzug 4%.
<i>Payment:</i>	<i>Export nach Vereinbarung / Export: according to offer</i>
Produkthaftung:	Kügele verpflichtet sich, ihren Kunden Entschädigungen zu ersetzen, die der Kunde auf Grund gesetzlicher Haftpflicht wegen eines Personen- oder Sachschadens hat leisten müssen. Dies gilt nur für Schäden, die nachweislich auf einen von Kügele verursachten Produktionsfehler zurückzuführen sind. Die Freistellung erfolgt nur in dem Umfang, in dem der Schaden von der Kügele verursacht ist.
<i>Product liability:</i>	<i>Kügele will pay compensation, which they are legally obliged to pay, for personal or property damage. This applies only for damages which arise due to a fault in products of Kügele. Only the amount of damage directly caused by our products is covered.</i>
Lieferkonditionen:	Die Lieferung erfolgt ausschließlich zu den auf unseren Rechnungen angeführten Bedingungen, insbesondere: Unter Eigentumsvorbehalt. Wir behalten uns das Eigentum an sämtlichen von uns gelieferten Waren bis zur Bezahlung unserer Gesamtforderungen aus der Geschäftsverbindung vor. Das gilt auch dann, wenn der Kaufpreis für bestimmte, vom Kunden bezeichnete Warenlieferungen bezahlt ist, da das vorbehaltene Eigentum als Sicherung für unser Saldoforderung dient.
<i>Deliveries:</i>	<i>Delivery will only take place on basis of the conditions quoted in our invoices. In particular: with respect to reservation of proprietary rights. All our product deliveries remain our property until the total amount outstanding in the client's account has been paid. This applies irrespective of which invoices for which deliveries have been paid; any products remaining can be considered the property of Kügele.</i>
*Lieferung Österreich:	Ab einem Netto-Warenwert von € 150,- frei Haus durch Spedition oder DPD. Bei Eigenzustellung am Wiener Platz verrechnen wir bis zu einem Netto-Warenwert von € 50,- Zustellgebühren von € 13,- und bis € 150,- eine Zustellgebühr von € 8,-. Bei Abholung: unter € 50,- nur gegen Barzahlung.
*Lieferung Deutschland:	siehe Beiblatt für Deutschland
Lieferung Ausland:	Mindestauftragswert € 500,-, ab Werk. Frei Haus auf Anfrage.
<i>Export delivery:</i>	<i>Minimum order € 500,-, prices ex works. Free domicile, on request.</i>
Fracht und Verpackung:	Bei Bezug von Mengen unter einer kompletten Verpackungseinheit wird, um Transportschäden zu vermeiden, zusätzlich notwendiges Verpackungsmaterial verrechnet. Verpackungsholz für Länge 2,70 m, EUR 3,- netto.
Transportschäden:	Transportschäden können nur anerkannt werden, wenn die Beschädigung auf dem Übernahmeschein vermerkt wurde. Die Reklamationsfrist beträgt längstens eine Woche. Lieferungen von Mindermengen erfolgen auf Risiko des Käufers. Für Retoursendungen mit beschädigter Verpackung verrechnen wir eine 20%ige Manipulationsgebühr!
<i>Damage in transit:</i>	<i>Damage in transit will only be accepted if the damage has been confirmed on the delivery note. Claims must be notified within one week of delivery. Small quantities are only delivered at the risk of the purchaser. For damaged packing a fee of 20% is payable.</i>
Rücksendungen:	Rücksendungen werden nur nach Einholung unseres Einverständnisses und bei einwandfreiem Zustand der Ware und Verpackung innerhalb von 6 Wochen übernommen. Unverpackte Ware wird nicht übernommen und geht auf Kosten des Rücksenders retour.
<i>Returns:</i>	<i>Returns will only be accepted with our prior, written (faxed) agreement. Goods must be in the original packing and in salable condition. Reshipment for returns is at the cost of the returner.</i>
Manipulationsgebühr:	Bei von uns unverschuldeten Retouren, berechnen wir eine 30%ige Manipulationsgebühr, mindestens jedoch € 3,-.

* **Sendungen österreichweit ab € 150,-** frachtfrei, Sendungen zwischen € 50,- und € 150,-, Frachtkostenanteil € 13,-, Mindestauftragshöhe € 50,- - **Kleinbestellungen werden gesammelt und gehen mit dem nächsten größeren Auftrag mit!**

Änderungen und Irrtümer vorbehalten! **Errors & omissions excepted!**

ERLÄUTERUNG ZU DEN METALLPROFILEN

Verpackungseinheiten:	5 oder 10 Stangen per Bund je nach Profiltype 5 oder 10 SB per Bund je nach Profiltype
Einzelstangen:	Mindermengenzuschlag unter 1 VE: + 10%.
Transport:	Auf Risiko des Kunden!
Maße und Farben:	Die angegebenen Maße sind Richtwerte, produktionsbedingte Abweichungen und Verbesserungen vorbehalten! Farbabweichungen sind produktionsbedingt möglich!
SB Profile:	Folienverpackt mit oder ohne Schrauben und Dübel, selbstklebend oder ungebohrt
Zuschnitte:	Ein Transportschnitt ist möglich und gratis. Für mehrere Schnitte wird ein Zuschlag von 25% auf den Netto-Stangenpreis verrechnet. Entstehende Reste werden nur auf Wunsch mitgeliefert. Schnitttoleranz: +/- 3 mm. Die Rücknahme von Zuschnitten, Sonderprofilen oder RAL Beschichtungen ist ausgeschlossen. Edelstahlprofile können generell nicht zugeschnitten oder gebohrt werden.
Einlagestreifen:	Profilpreise gelten immer ohne Einlagestreifen!
Selbstklebend:	Bei losen Profilen ergibt sich ein Zuschlag von € 0,70 netto per lfm pro Seite.
Bohrzuschlag:	Bei ungebohrten Profilen wird für gewünschte Bohrung € 0,39 netto per lfm verrechnet.
Einschneidegebühr:	1 Schnitt auf je 1,5 cm € 3,54/lfm netto
Bei Sonderanfertigungen behalten wir uns eine Über-/Unterlieferung von +/- 10% gegenüber der Bestellmenge vor.	
Änderungen und Irrtümer vorbehalten!	

IMPORTANT HINTS FOR METAL PROFILES

Packing units:	5 or 10 profiles per unit, depending on type of profile. D.I.Y. packing 5 or 10 profiles per unit
Non-standard packing units:	non-standard packing units: + 10% extra charge
Transport :	At the risk of the purchaser!
Measures and colours:	The indicated measures are approximations, subject to manufacturing variations! Constant colours cannot be guaranteed due to production!
D.I.Y. packing:	foiled packed with headers, with or without screws and plugs
Cut service:	One cut is free of charge. For further cuts we charge + 25% Off-cuts will only be added if requested. Cutting tolerance: +/- 3 mm Return of special blanks or RAL coated is not possible. We do not cut or drill profiles made of stainless steel.
Inserts:	Our prices are without insert strips!
Self-adhesive equipment:	Surcharge € 0,70 net per meter one side only.
Drilling charge:	for undrilled profiles € 0,39 net per meter.
Prepunching:	one cut each 1,5 cm to allow bending € 3,54 net per meter.
For all specially manufactured products we reserve our right of an over / under delivery of +/- 10% relating to the originally ordered quantity.	
Errors & omissions excepted!	

INDEX zur PROFILPREISLISTE 2014/15

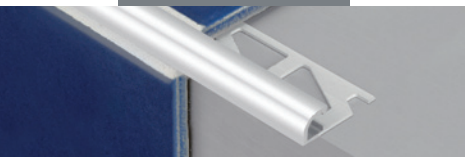
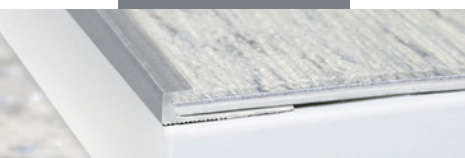

MEHRTEILIGE SYSTEME

TRIO GRIP® und TRIO GRIP® twist		Seite	5 bis 10
CONFIGO Klemmsystem von 3,6 mm bis 7 mm	NEU	Seite	11 bis 13
CAVUM Schraubsystem von 3,9 mm bis 7,6 mm	NEU	Seite	15 bis 17
STS Schraubsystem von 7-15 mm und 15-23 mm	NEU	Seite	19 bis 21
DUO GRIP 2-teiliges Clipsystem		Seite	23 bis 29
T-FLEX® Klemmsystem		Seite	31 bis 35
SOLUM 2-teiliges, schwenkbares Profilsystem von 7 mm bis 16,5 mm	NEU	Seite	37 bis 39
RENO TREPPEN RENOVIERUNGSPROFILE	NEU	Seite	41 bis 45
SCHLAG DÜBEL SYSTEM	NEU	Seite	47 bis 48
TREPPENKANTENPROFIL 2-teilig	NEU	Seite	49

MONOPROFILE (einteilig)

LAMINAT- und PARKETTPROFILE		Seite	52 bis 57
BIEGEPROFILE für Laminat und Parkett		Seite	58 bis 59
T-PROFILE		Seite	60
WINKELPROFILE		Seite	63 bis 65
NASENSCHIENEN		Seite	66 bis 67
ABSCHLUSSPROFILE und TREPPENKANTEN für Kunststoffbeläge		Seite	68 bis 72
KLEMM- und DEHNFUGENPROFILE für Kunststoffbeläge		Seite	70
ÜBERGANGSPROFILE flach		Seite	73 bis 75
HOHLFLACHSCHIENEN		Seite	76 bis 79
TERRASSENPROFILE	NEU	Seite	79
TREPPENKANTEN		Seite	81 bis 87
EINLAGESTREIFEN in Kunststoff und Siliciumkarbid		Seite	88 bis 89
MAUERKANTEN selbstklebend		Seite	85 und 91
ESTRICHWINKEL		Seite	91
SOCKELLEISTEN ein- und zweiteilig	NEUE MODELLE	Seite	93 bis 101
SÄULENRINGE	NEU	Seite	101
FLIESENPROFILE	NEUE MODELLE	Seite	103 bis 115

ZUBEHÖR

MONTAGEKLEBER, SILIKON, ACRYL	NEU	Seite	124
FERAX	NEU	Seite	125
PAFUDIMA Spachtelmasse		Seite	126
BEFESTIGUNGSMATERIAL, SCHRAUBEN, DÜBEL und NÄGEL	NEU	Seite	127 bis 128
WERKZEUGE	NEU	Seite	129 bis 146
TREPPENLÄUFERSTANGEN und ZUBEHÖR		Seite	117 bis 121
LAMINAT- und PARKETTUNTERLAGEN	NEU	Seite	147 bis 150
PROMOTION MATERIAL		Seite	151 bis 152

TRIO GRIP® twist und TRIO GRIP®

Das einzige Schraubsystem mit abgedecktem Schraubenkanal
The unique screwing-profile-system with covered screw-channel



TRIO GRIP[®] twist Schraubensystem in Aluminium für Laminat und Parkett

ÜBERGANGSPROFILE - komplett mit Grundprofil 7400

Schwenkbar und verstellbar in Höhe und Neigung! Inklusive Grundprofil 7400 (10-24 mm), patentierter, abgedeckter Schraubenkanal, Kreuzschlitzschrauben, Einlagestreifen mit Rillung.

TRIO GRIP[®] twist screwing-system in Aluminium for laminate and parquet





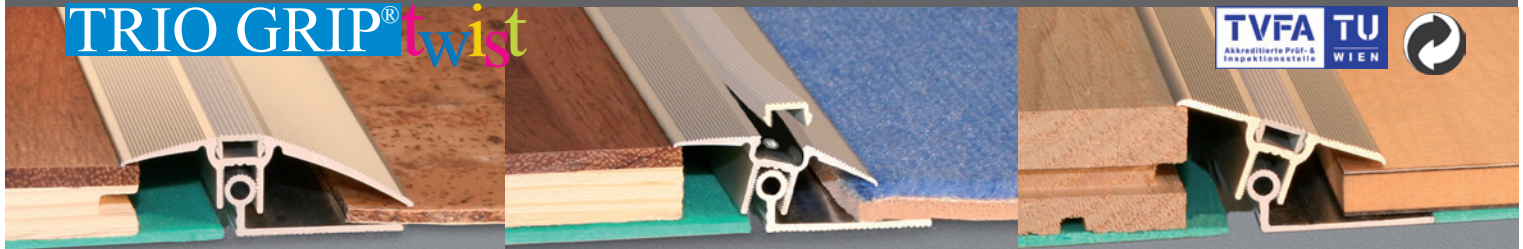





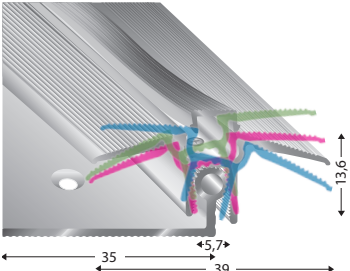

JOINING PROFILES - complete with base profile 7400

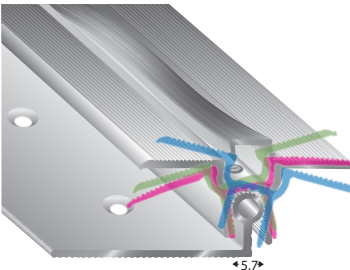
Swivelling and adjustable in height and angle! Incl. base profile 7400 (10-24 mm), patented insert screw channel, pozi drive screws, grooved insert strip.

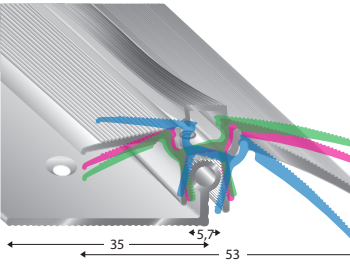

HINWEIS: Bitte beachten Sie die unterschiedlich langen senkrechten Stege des Deckprofiles. Sie erhöhen zusätzlich die Variationsmöglichkeit! Die Höhenverstellbarkeit ist so berechnet, dass unter dem Boden eine 2-3 mm starke Unterlage verwendet wird. Sollte auf dem Boden bereits eine Unterlage aufkaschiert sein, so ist diese von der Gesamthöhe abzuziehen. Beispiel: ein 8 mm Boden/Laminat mit einer aufkaschierten 2 mm Unterlage ist als 8 mm Boden zu sehen!

HINTS: Please note the cover profile has two different base heights, to accommodate more floor heights! Calculation of the height adjustability of the profile has included allowance for a 2-3 mm thick underlay. Where a floor has a bonded underlay, the thickness of the underlay should be subtracted from the total profile size to obtain the thickness of the flooring i.e. the profile size required is the bonded underlay plus the thickness of the flooring. Example: an 8 mm laminate flooring (or alternatively the floor itself) with a bonded underlay of 2 mm is equivalent to an 8 mm thick flooring!

	Artikel-Nr. article-no.	Farbe colour	Beschreibung description	VE unit	Preis/lfm price/lfm 270 cm	Preis/Stück price/piece 90 cm
inkl. Grundprofil / Base profile 7400 	TGT 200	silber / silver	Übergangprofil System gewölbt komplett für 10-18 mm Complete joining profile system curved for 10-18 mm	5	•	•
		sand / sand		5	•	•
		gold / gold		5	•	•
		bronze / bronze		5	•	•
		EO	Edelstahloptik / stainless steel optic 	5	•	•
		Holzdekor / wooden decor		5	•	•
inkl. Grundprofil / Base profile 7400 	TGT 210	silber / silver	Übergangprofil System flach komplett für 14-22 mm Complete joining profile system flat for 14-22 mm	5	•	•
		sand / sand		5	•	•
		gold / gold		5	•	•
		bronze / bronze		5	•	•
		EO	Edelstahloptik / stainless steel optic 	5	•	•
		Holzdekor / wooden decor		5	•	•
inkl. Grundprofil / Base profile 7400 	TGT 400	silber / silver	Schrägprofil System hoch komplett für 12-24 mm Complete joining profile system high for 12-24 mm	5	•	•
		sand / sand		5	•	•
		gold / gold		5	•	•
		bronze / bronze		5	•	•
		EO	Edelstahloptik / stainless steel optic 	5	•	•
		Holzdekor / wooden decor		5	•	•

TRIO GRIP[®] twist Schraubensystem in Aluminium für Laminat und Parkett

ÜBERGANGSPROFILE - komplett mit Grundprofil 7300

Schwenkbar und verstellbar in Höhe und Neigung! Inklusive Grundprofil 7300 (7-15 mm), patentierter, abgedeckter Schraubenkanal, Kreuzschlitzschrauben, Einlagestreifen mit Rillung.

TRIO GRIP[®] twist screwing-system in Aluminium for laminate and parquet







JOINING PROFILES - complete with base profile 7300

Swivelling and adjustable in height and angle! Incl. base profile 7300 (7-15 mm), patented insert screw channel, pozi drive screws, grooved insert strip.

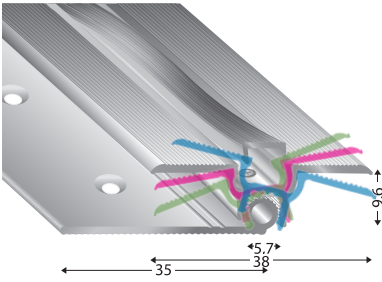
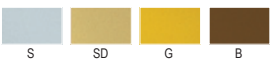

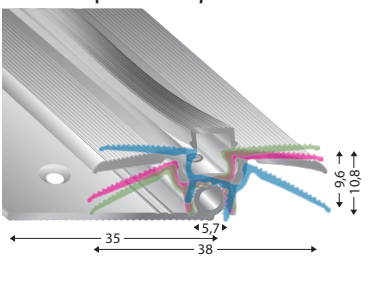
HINWEIS: Bitte beachten Sie die unterschiedlich langen senkrechten Stege des Deckprofiles. Sie erhöhen zusätzlich die Variationsmöglichkeit! Die Höhenverstellbarkeit ist so berechnet, dass unter dem Boden eine 2-3 mm starke Unterlage verwendet wird. Sollte auf dem Boden bereits eine Unterlage aufkaschiert sein, so ist diese von der Gesamthöhe abzuziehen. Beispiel: ein 8 mm Boden/Laminat mit einer aufkaschierten 2 mm Unterlage ist als 8 mm Boden zu sehen!

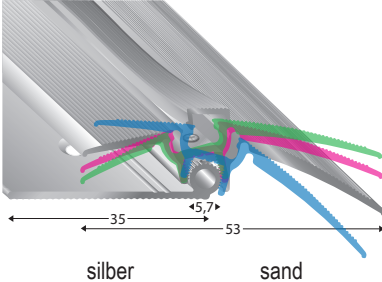
HINTS: Please note the cover profile has two different base heights, to accommodate more floor heights! Calculation of the height adjustability of the profile has included allowance for a 2-3 mm thick underlay. Where a floor has a bonded underlay, the thickness of the underlay should be subtracted from the total profile size to obtain the thickness of the flooring i.e. the profile size required is the bonded underlay plus the thickness of the flooring. Example: an 8 mm laminate flooring (or alternatively the floor itself) with a bonded underlay of 2 mm is equivalent to an 8 mm thick flooring!

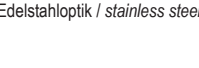
	Artikel-Nr. article-no.	Farbe colour	Beschreibung description	VE unit	Preis/lfm price/lfm 270 cm	Preis/Stück price/piece 90 cm				
inkl. Grundprofil / Base profile 7300 	TGT 220	silber / silver	Übergangsprofil System flach komplett für 8-14 mm Complete joining profile system flat for 8-14 mm 	5	•	•				
		sand / sand								
		gold / gold								
		bronze / bronze								
		EO					Edelstahloptik / stainless steel optic	5	•	•
		Holzdekor / wooden decor						5	•	•
inkl. Grundprofil / Base profile 7300 	TGT 230	silber / silver	Schrägprofil System hoch komplett für 7-11 mm Complete joining profile system high for 7-11 mm 	5	•	•				
		sand / sand								
		gold / gold								
		bronze / bronze								
		EO					Edelstahloptik / stainless steel optic	5	•	•
inkl. Grundprofil / Base profile 7300 	TGT 420	silber / silver	Schrägprofil System hoch komplett für 3-9 mm Complete joining profile system high for 3-9 mm 	5	•	•				
		sand / sand								
		gold / gold								
		bronze / bronze								
		EO					Edelstahloptik / stainless steel optic	5	•	•
								5	•	•

silber
silver

sand
sand

gold
gold

bronze
bronze

Edelstahloptik
stainless steel optic

Buche hell
10
light beech

Eiche
12
oak

Ahorn
14
maple



TRIO GRIP® Schraubensystem in Aluminium für Laminat und Parkett

ENDPROFIL und TREPPENKANTEN - komplett

Deck-, und Grundprofile, Einlagestreifen, inkl. Befestigungsmaterial bestehend aus Schrauben und Dübel zur Montage des Grundprofils und 3 Set Schrauben zur höhenvariablen Befestigung des Deckprofils im Grundprofil.

HINWEIS: die Höhenverstellbarkeit ist so berechnet, dass unter dem Boden eine 2-3 mm starke Unterlage verwendet wird. Sollte auf dem Boden bereits eine Unterlage aufkaschiert sein, so ist diese von der Gesamthöhe abzuziehen. Beispiel: ein 8 mm Boden/Laminat mit einer aufkaschierten 2 mm Unterlage ist als 8 mm Boden zu sehen!

TRIO GRIP® screwing system in Aluminium for laminate and parquet

ENDPROFILE and STAIR NOSINGS - complete

Cover profile, grooved insert strip and base profile incl. mounting material, screws and dowels for mounting the base profile and 3 sets of screws for the height-adjustable assembling of the cover profile in the base profile.

HINTS: Calculation of the height adjustability of the profile has included allowance for a 2-3 mm thick underlay. Where a floor has a bonded underlay, the thickness of the underlay should be subtracted from the total profile size to obtain the thickness of the flooring i.e. the profile size required is the bonded underlay plus the thickness of the flooring. Example: an 8 mm laminate flooring (or alternatively the floor itself) with a bonded underlay of 2 mm is equivalent to an 8 mm thick flooring!



TRIO GRIP®

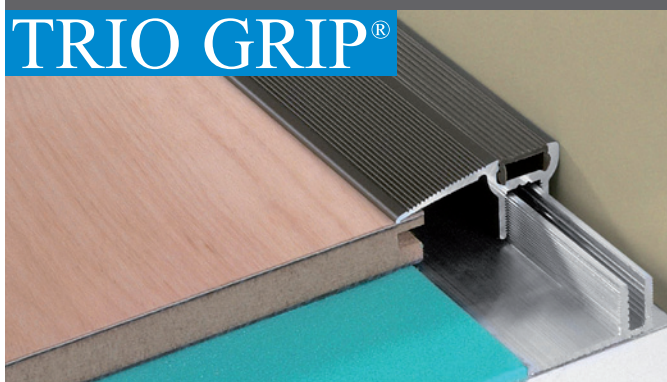

inkl. Grundprofil / Base profile 7100

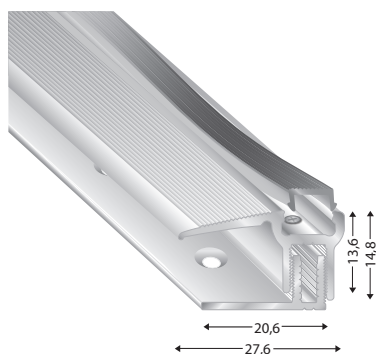

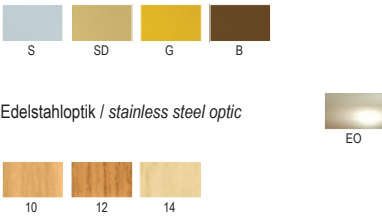
Artikel-Nr. article-no.	Farbe colour	Beschreibung description	VE unit	Preis/lfm price/lfm 270 cm	Preis/Stück price/piece 90 cm
LP 9100	silber / silver	Abschlussprofil System komplett für 8-15 mm Complete End profile system for 8-15 mm	5	•	•
	sand / sand		5	•	•
	gold / gold		5	•	•
	bronze / bronze		5	•	•
	EO		5	•	•
	Edelstahloptik / stainless steel optic		5	•	•
	Holzdekor / wooden decor		5	•	•
					

inkl. Grundprofil / Base profile 7000

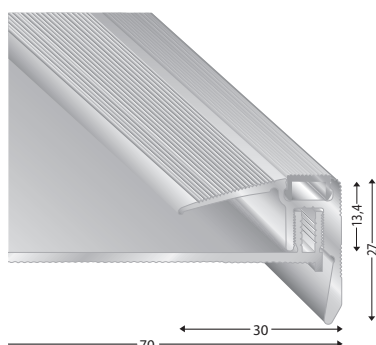

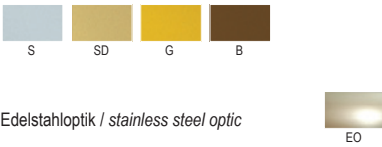
Artikel-Nr. article-no.	Farbe colour	Beschreibung description	VE unit	Preis/lfm price/lfm 270 cm	Preis/Stück price/piece 135 cm
LP 9600	silber / silver	Stufenprofil System komplett für 8-15 mm Complete stair nose system for 8-15 mm	5	•	•
	sand / sand		5	•	•
	gold / gold		5	•	•
	bronze / bronze		5	•	•
	EO		5	•	•
	Edelstahloptik / stainless steel optic		5	•	•
					

TRIO GRIP® und TRIO GRIP® twist - Schraubsystem in Aluminium für Laminat und Parkett

ERSATZTEILE - GRUNDPROFILE inklusive Befestigungsmaterial







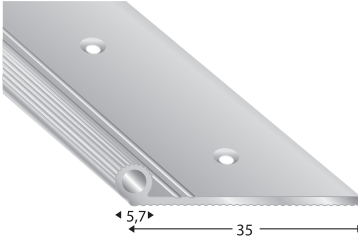

Befestigungssysteme für TRIO GRIP® und TRIO GRIP® twist - (Grundprofil in Aluminium)

TRIO GRIP® and TRIO GRIP® twist - Screwing system in aluminium for laminate and parquet

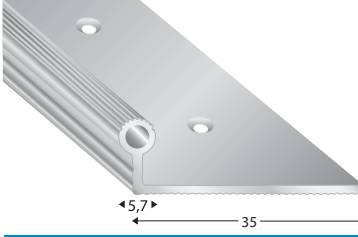
SPARE-PARTS - BASE PROFILES mounting material included

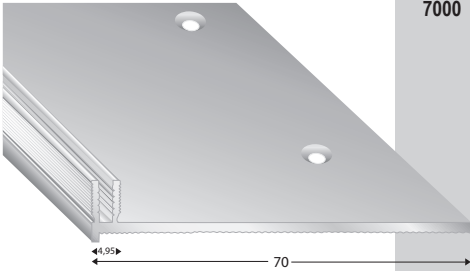
Mounting system for TRIO GRIP® and TRIO GRIP® twist - (Base profile in raw aluminium)

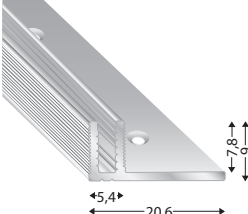
TRIO GRIP® twist

	Artikel-Nr. article-no.	Farbe colour	Beschreibung description	VE unit	Preis/lfm price/lfm 270 cm	Preis/Stück price/piece 90 cm
	7300 ROH	roh / raw	Grundprofil für ÜBERGANGSPROFIL TGT 220, TGT 230 und TGT 420 von 7-15 mm base profile for JOINING PROFILE TGT 220, TGT 230 and TGT 420 from 7-15 mm versenkt gebohrt - countersunk drilled  R = Alu roh / alu raw	5	•	•
	7400 ROH	roh / raw	Grundprofil für ÜBERGANGSPROFIL TGT 200, TGT 210, TGT 400, von 10-24 mm base profile for JOINING PROFILE TGT 200, TGT 210, TGT 400, from 10-24 mm versenkt gebohrt - countersunk drilled  R = Alu roh / alu raw	5	•	•
	Artikel-Nr. article-no.	Farbe colour	Beschreibung description	VE unit	Preis/lfm price/lfm 270 cm	Preis/Stück price/piece 135 cm
	7000 ROH	roh / raw	Grundprofil für TREPPENKANTE LP 9600 für 8-15 mm Belaghöhe base profile for STAIR NOSING LP 9600 for 8-15 mm height of floor versenkt gebohrt - countersunk drilled  R = Alu roh / alu raw	5	•	•
	7100 ROH	roh / raw	Grundprofil für ABSCHLUSSPROFIL LP 9100 für 8-15 mm Belaghöhe base profile for END PROFILE LP 9100 for 8-15 mm height of floor versenkt gebohrt - countersunk drilled  R = Alu roh / alu raw	5	•	•

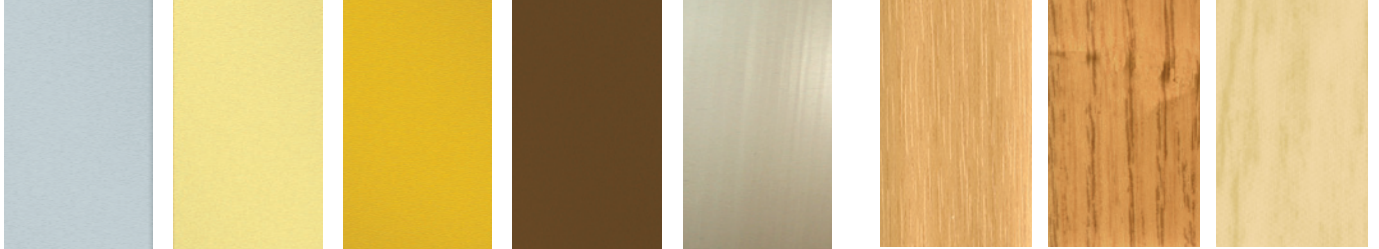

silber
silver

sand
sand

gold
gold

bronze
bronze

Edelstahloptik
stainless steel optic

Buche hell
10
light beech

Eiche
12
oak

Ahorn
14
maple

Eloxalfarben / anodized colours

HD = Holzdekor

WD = wooden decor

TRIO-GRIP®twist Verlegeanleitung TRIO-GRIP®twist laying instruction



Das bereits vorgebohrte Grundprofil (Basisprofil) auf den Unterboden (z.B. Estrich) mit den beiliegenden Dübeln und Schrauben oder mit Montagekleber (z.B. Powergrip) befestigen.
Fix the pre-drilled base profile to the bare floor (e.g. stone) with the dowels and screws provided or with fixing glue (e.g. Powergrip).



Das bereits ebenfalls vorgebohrte Deckprofil auf das Grundprofil je nach Neigung aufsetzen, fest niederdrücken und mit beiliegenden Schrauben fixieren.
Screw or glue predrilled coverprofile on the base profile, press it home until resistance and screw .

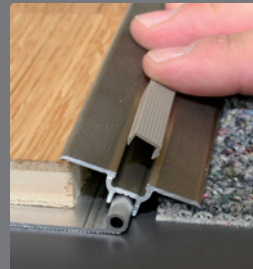

Abdeckprofil mit den Rillen nach oben in den Schraubenkanal eindrücken, um die Schrauben abzudecken.
To hide the screws, push the screw-covering profile (the cover insert with the grooves) from above into the screw channel of the aluminium cover profile.

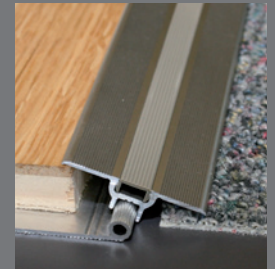

FERTIG!
JOB DONE!

TRIO-GRIP® Verlegeanleitung TRIO-GRIP® laying instruction

Das bereits vorgebohrte Grundprofil (Basisprofil) auf den Unterboden (z.B. Estrich) mit den beiliegenden Dübeln und Schrauben oder mit Montagekleber (z.B. Powergrip) befestigen.
Fix the pre-drilled base profile to the bare floor (e.g. stone) with the dowels and screws provided or with fixing glue (e.g. Powergrip).

Das bereits ebenfalls vorgebohrte Deckprofil auf das Grundprofil aufsetzen, bis zum Widerstand des Bodens niederdrücken und mit den beiliegenden Kreuzschlitzschrauben fixieren.
Place the (also) pre-drilled cover profile in the secured base profile and press it home until the resistance of the floorings is met. Then screw the cover profile to the base profile with the cross-headed screws provided.

Abdeckprofil mit den Rillen nach oben in den Schraubenkanal eindrücken, um die Schrauben abzudecken.
To hide the screws, push the screw-covering profile (the cover insert with the grooves) from above into the screw channel of the aluminium cover profile.

FERTIG!
JOB DONE!

NEU / NEW

CONFIGO

Klemmsystem für LVT und Designbeläge

Clip System for LVT and designfloorings

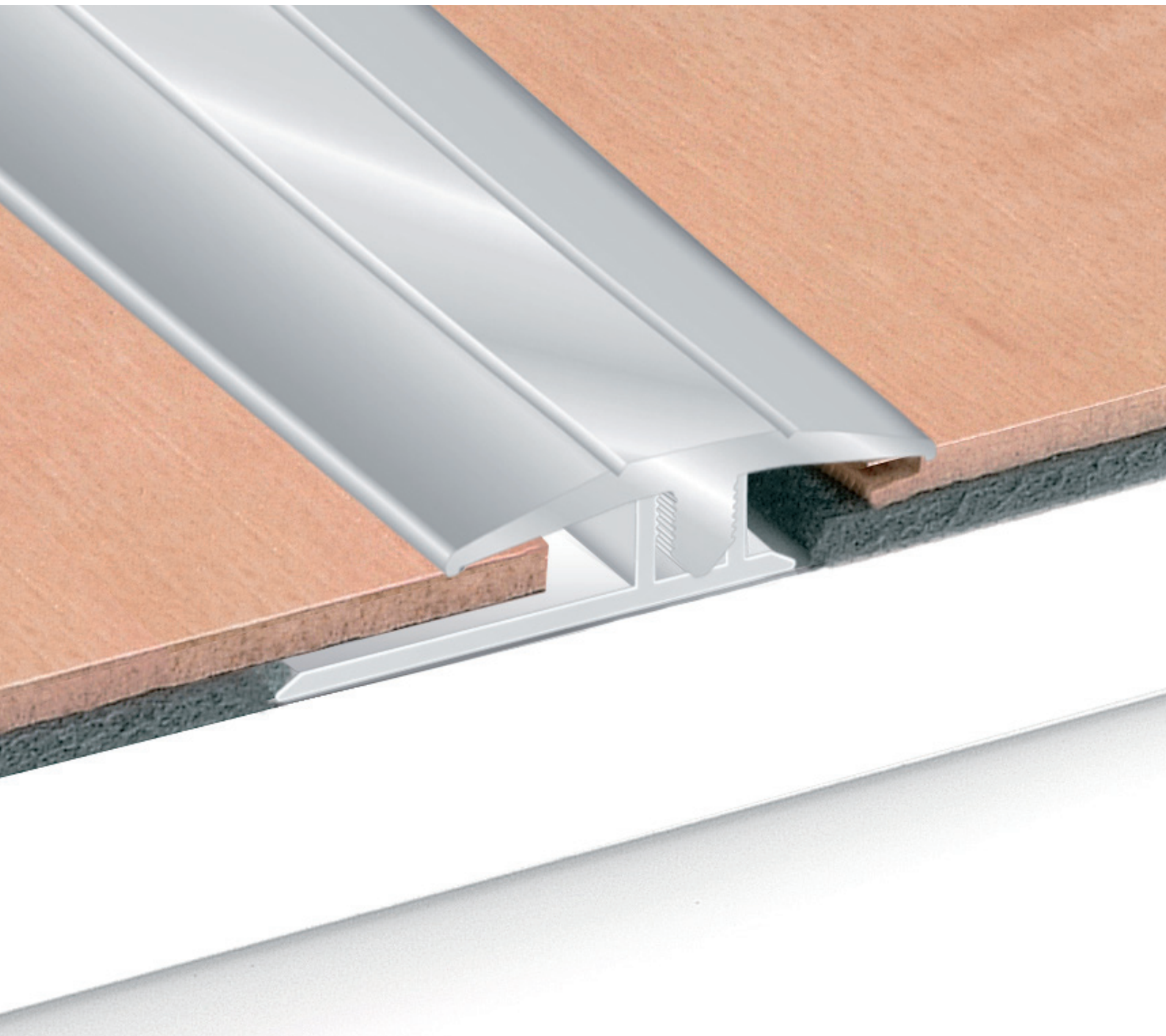

„CONFIGO“ Klemmsystem für LVT und Designbeläge von 3,6-7 mm

ÜBERGANGS-, AUSGLEICH- und ABSCHLUSSPROFIL

„CONFIGO“ Clip System for LVT and designfloorings for heights of 3,6-7 mm

JOINING-, LEVEL ADAPTING- and ENDPROFILE

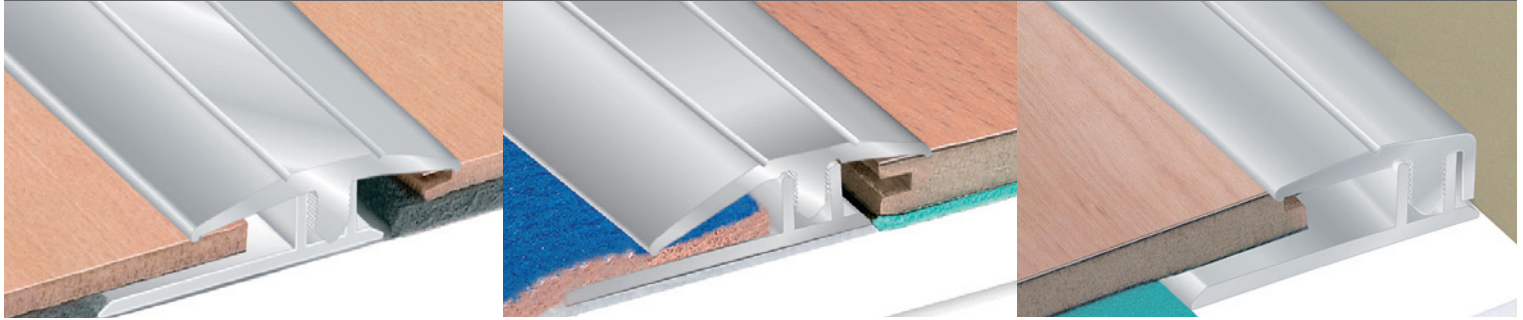

NEU / NEW

	Artikel-Nr. article-no.	Farbe colour	Beschreibung description	VE unit	Preis/lfm price/lfm 270 cm	Preis/Stück price/piece 100 cm
	CFG221	silber / silver	Abschlussprofil für LVT und Designbeläge für Höhen von 3,6 - 7 mm End-profile profile system for LVT and designfloorings for heights of 3,6 - 7 mm	10	•	•
		sand / sand		10	•	•
		gold / gold		10	•	•
		bronze / bronze		10	•	•
		EO		10	•	•
	CFG230	silber / silver	Übergangsprofil für LVT und Designbeläge für Höhen von 3,6 - 7 mm Joining profile system for LVT and designfloorings for heights of 3,6 - 7 mm	10	•	•
		sand / sand		10	•	•
		gold / gold		10	•	•
		bronze / bronze		10	•	•
		EO		10	•	•
	CFG233	silber / silver	Ausgleichsprofil für LVT und Designbeläge für Höhen von 3,6 - 7 mm Level-adapting profile system for LVT and designfloorings for heights of 3,6 - 7 mm	10	•	•
		sand / sand		10	•	•
		gold / gold		10	•	•
		bronze / bronze		10	•	•
		EO		10	•	•

„CONFIGO“ Klemmsystem für LVT und Designbeläge von 3,6-7 mm

TREPPENKANTENPROFIL

„CONFIGO“ Clip System for LVT and designfloorings for heights of 3,6-7 mm

STAIR NOSING PROFILE

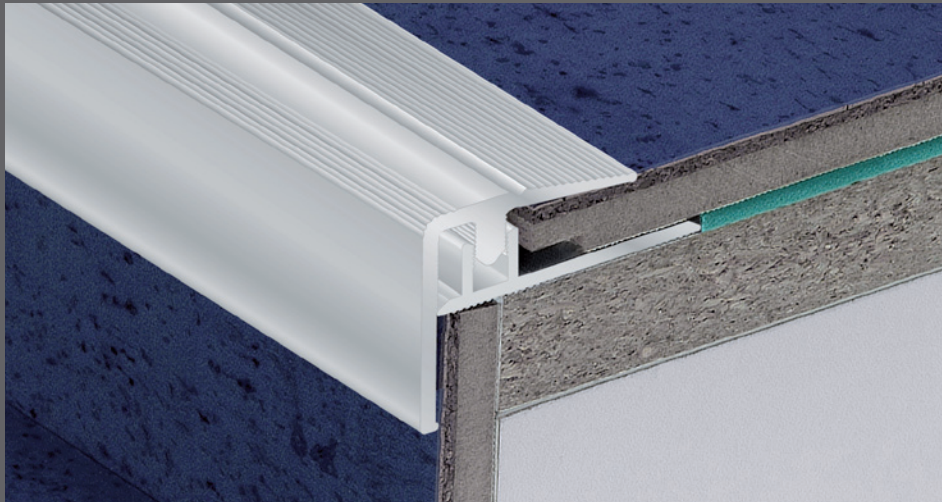

NEU / NEW



Artikel-Nr. article-no.	Farbe colour	Beschreibung description	VE unit	Preis/Stange price/unit 300 cm	Preis/Stück price/piece 150 cm
CFG625	silber / silver	Treppenkantenprofil für LVT und Designbeläge für Höhen von 3,6 - 7 mm Stair-nosing profile system for LVT and designfloorings for heights of 3,6-7 mm S	5	•	•

RENOVATIONSCLIP

NEU / NEW

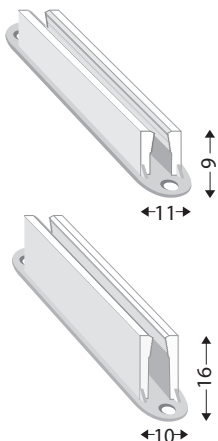

Artikel-Nr. article-no.	Farbe colour	Beschreibung description	VE unit	Preis/Einheit price/unit
LC 5201		Renovationsclip Clip (POM white) (weiß) zum nachträglichen Einbau for renovation or subsequent installation für 6-10 mm / for 6-10 mm	1	•
LC 5204			4	•
PC 5701		Renovationsclip Clip (POM white) (weiß) zum nachträglichen Einbau for renovation or subsequent installation für 10-15 mm / for 10-15 mm	1	•
PC 5704			4	•

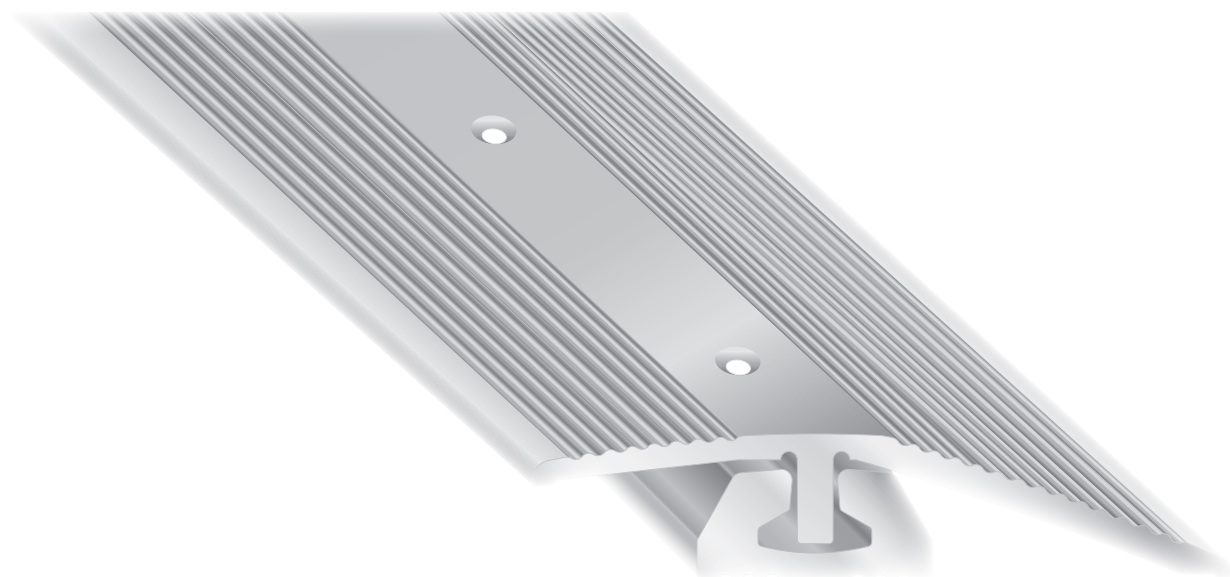

CAVUM

NEU / NEW

CAVUM

Das schmalste, schwenkbare 2-teilige Schraubsystem
für LVT und Designbeläge inkl. Befestigungsmaterial

*The smallest, screwing-profile-system with covered screw-channel
for LVT and designfloor incl. screws set*

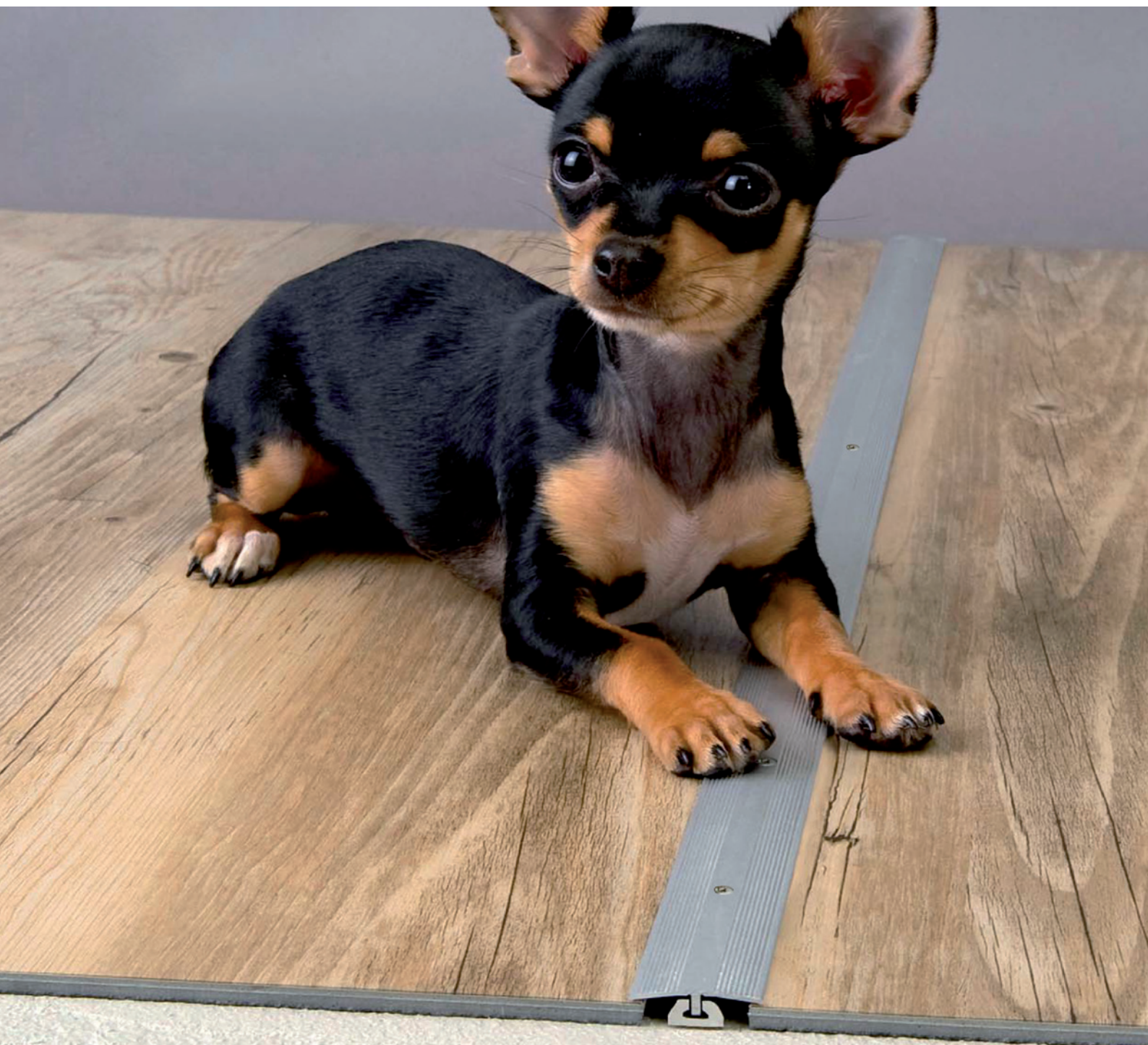

PROFILSERIE „CAVUM“ für LVT und Designbeläge - inkl. Befestigungsmaterial

CAVUM



Die zwei kleinsten ihrer Sorte!



CAVUM flex relies on an exclusive two-part screw system, which currently is the smallest screw system in the world, in order to keep these coverings movable.

For instance, this unique profile is variable in height and it also allows tilting. User-friendly and tensile screws facilitate a continuously variable laying.

Extraordinary is also the remarkably slim design with a particularly room-saving, innovative basic profile being complemented by a slim counterpart formed by sophisticated tilting upper components.

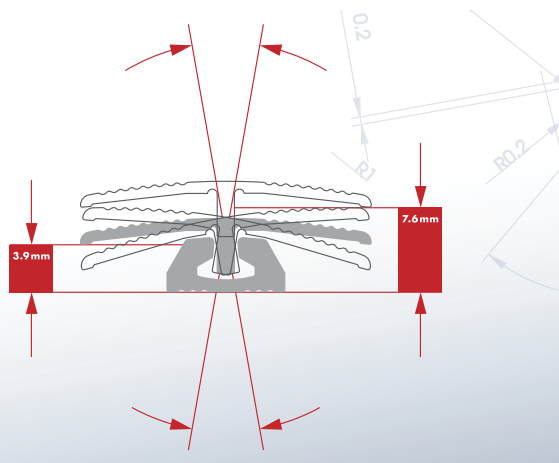

Das schmalste Schraubsystem der Welt!

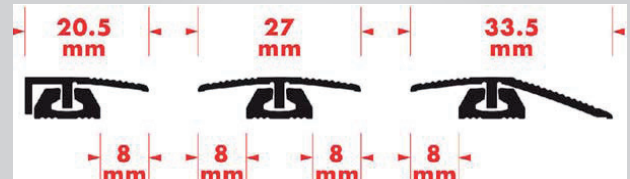

Schraubsysteme erfreuen sich hoher Beliebtheit und haben einen sehr hohen Marktanteil. Gerade bei schwimmend verlegten Belägen wie z.B. Parkett und Laminat bieten die Profile verschiedene

- zum Verlegen schwimmender LVT Beläge
- derzeit das kleinste Schraubprofilssystem der Welt
- extrem schlankes Design
- höhenvariabel und schwenkbar

Vorteile:

- Beläge können arbeiten
- große, stufenlose Höhenvariabilität
- große Überdeckung, daher einfache Verlegung
- einfache Demontierbarkeit des Oberprofils
- einfaches Austauschen des Belages

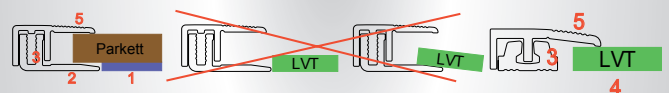

Der andere Ansatz von CAVUM:

Im Gegensatz zu Laminat und Parkett wird LVT in der Regel ohne Unterlage (1) verlegt. Daher würde der Steg (2) am Basisprofil (3) bei LVT Belägen (4) stören. Da CAVUM ohne den Steg auskommt, kann der Belag in dem Bereich arbeiten und CAVUM kann mit schmalen Oberprofilen (5) 8mm Bewegungsfreiheit garantieren!

Vorteile von CAVUM:

- 1 Für Beläge ab 3,9 mm
- 2 große, stufenlose Höhenvariabilität bis 7,6 mm
- 3 Grosse Schwenkbarkeit mit nur 2 Profilen (Andere Produkte im Markt brauchen 3)
- 4 sehr schmale Oberprofile
- 5 elegantes Design
- 6 8 mm Bewegung vom Belag möglich
- 7 Einfache Montage
- 8 Alles im Lieferumfang dabei

PROFILSERIE „CAVUM“ für LVT und Designbeläge -

inkl. Befestigungsmaterial / mounting material included

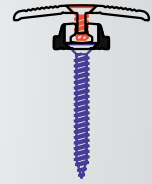

von Höhen 3,9 - 7,6 mm mit Lifter bis 11,6 mm
from heights 3,9 - 7,6 mm with lifter to 11,6 mm

NEU / NEW

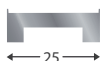
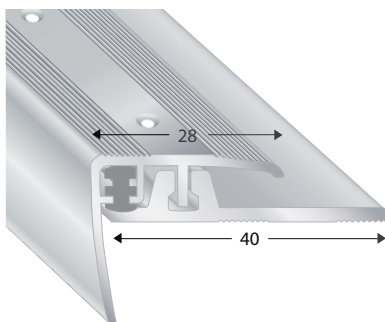
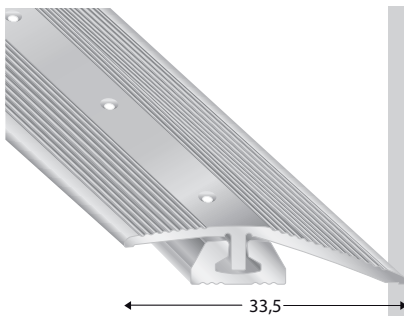
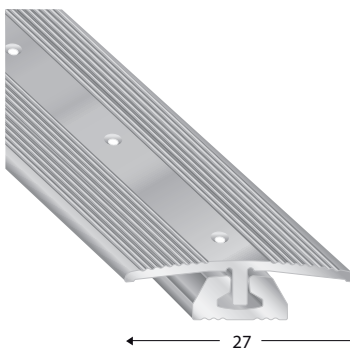
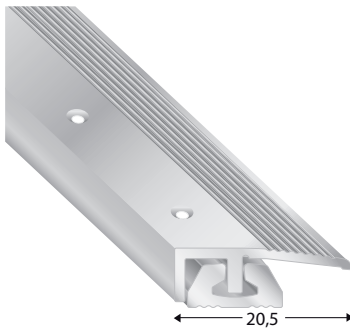

Artikel-Nr. article-no.	Farbe colour	Beschreibung description	VE unit	Preis/Stange price/unit 270 cm	Preis/Stück price/piece 100 cm
79177 20	silber / silver	ABSCHLUSSPROFIL 2-teilig, gebohrt End profile - 2 part, drilled, Höhen / heights 3,9-7,6 mm 	10	•	
79177 25	sand / sand		10	•	
79177 30	gold / gold		10	•	
79177 40	bronze / bronze		10	•	
79177 15	EO	Edelstahl optik / stainless steel optic 	10	•	
79177 20 100	silber / silver		10		•
79177 25 100	sand / sand		10		•
79177 30 100	gold / gold		10		•
79177 40 100	bronze / bronze		10		•
79177 15 100	EO	Edelstahl optik / stainless steel optic 	10		•
79175 20	silber / silver	ÜBERGANGSPROFIL 2-teilig, gebohrt Joining profile - 2 part, drilled, Höhen / heights 3,9-7,6 mm 	10	•	
79175 25	sand / sand		10	•	
79175 30	gold / gold		10	•	
79175 40	bronze / bronze		10	•	
79175 15	EO	Edelstahl optik / stainless steel optic 	10	•	
79175 20 100	silber / silver		10		•
79175 25 100	sand / sand		10		•
79175 30 100	gold / gold		10		•
79175 40 100	bronze / bronze		10		•
79175 15 100	EO	Edelstahl optik / stainless steel optic 	10		•
79179 20	silber / silver	AUSGLEICHSPROFIL 2-teilig, gebohrt Level-adapting profile - 2 part, drilled Höhen / heights 3,9-7,6 mm 	10	•	
79179 25	sand / sand		10	•	
79179 30	gold / gold		10	•	
79179 40	bronze / bronze		10	•	
79179 15	EO	Edelstahl optik / stainless steel optic 	10	•	
79179 20 100	silber / silver		10		•
79179 25 100	sand / sand		10		•
79179 30 100	gold / gold		10		•
79179 40 100	bronze / bronze		10		•
79179 15 100	EO	Edelstahl optik / stainless steel optic 	10		•
79173 20	silber / silver	TREPPENKANTENPROFIL 2-teilig, gebohrt STAIR NOSING profile - 2 part, drilled Höhen / heights 3-8 mm 	10	•	
79173 25	sand / sand		10	•	
79173 30	gold / gold		10	•	
79173 40	bronze / bronze		10	•	
79173 15	EO	Edelstahl optik / stainless steel optic 	10	•	
		auf Anfrage / on request			
Artikel-Nr. article-no.	Farbe colour	Beschreibung description	VE unit	Preis/Stück price/unit	
79175 98	roh / raw	Lifter aus Kunststoff - bis max. 11,6 mm Lifter in synthetic - up to max. 11,6 mm	10	•	

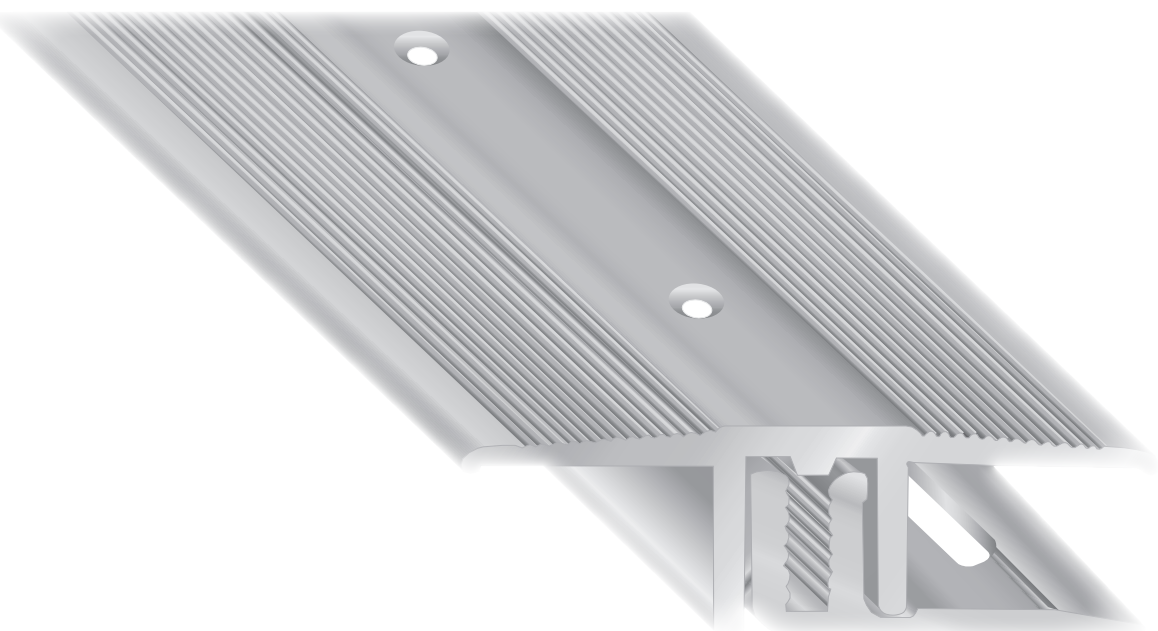

STS

NEU / NEW

STS

Schraubsystem 7-15 mm und 15-23 mm

SET inkl. Schrauben und Dübel

Screwing-profile-system for 7-15 mm and 15-23 mm

incl. screws set and dowels

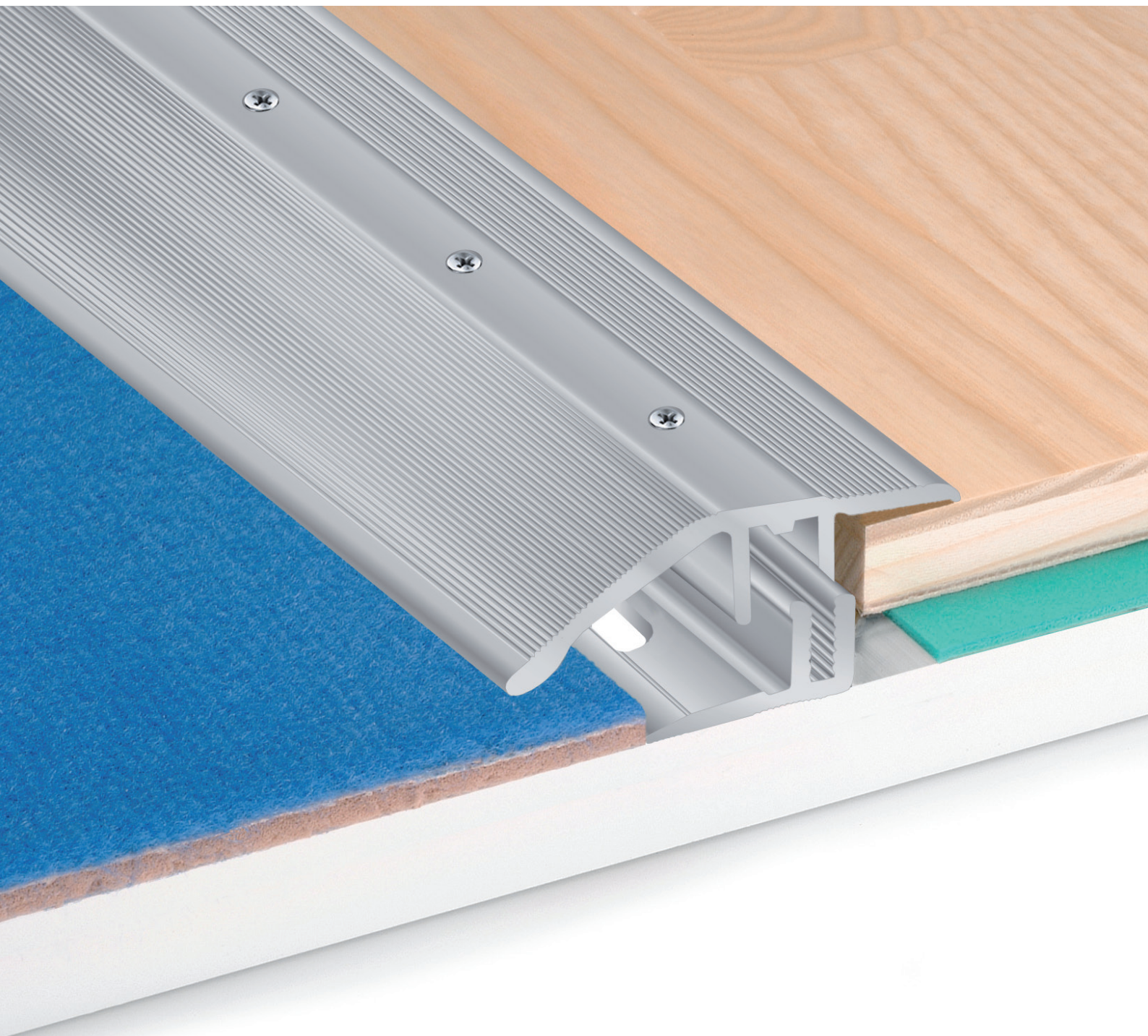



STS - Schraubsystem 7-15 mm - SET inkl. Schrauben und Dübel

STS - Screwing-profile-system for 7-15 mm - SET incl. screws and dowels



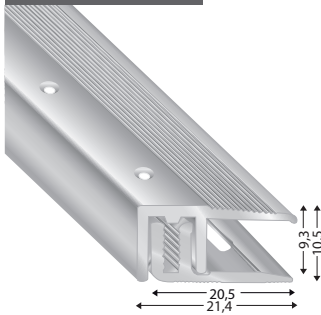

SERIE 1



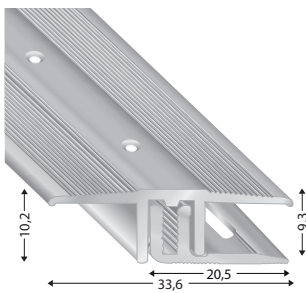

Artikel-Nr. article-no.	Farbe colour	Beschreibung description	VE unit	Preis/Stange price/unit 270 cm	Preis/Stück price/piece 90 cm	Preis/Stück price/piece 100 cm
STS 21	silber / silver	ABSCHLUSSPROFIL von 7-15 mm End profile for heights 7-15 mm 	10	•	•	•
	sand / sand		10	•	•	•
	gold / gold		10	•	•	•
	bronze / bronze		10	•	•	•
	EO		10	•	•	•
		Edelstahloptik / stainless steel optic				

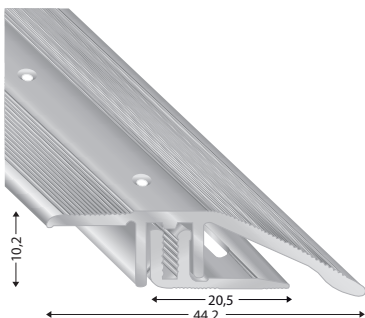

Artikel-Nr. article-no.	Farbe colour	Beschreibung description	VE unit	Preis/Stange price/unit 270 cm	Preis/Stück price/piece 90 cm	Preis/Stück price/piece 100 cm
STS 33	silber / silver	ÜBERGANGSPROFIL von 7-15 mm Joining profile for heights 7-15 mm 	10	•	•	•
	sand / sand		10	•	•	•
	gold / gold		10	•	•	•
	bronze / bronze		10	•	•	•
	EO		10	•	•	•
		Edelstahloptik / stainless steel optic				



Artikel-Nr. article-no.	Farbe colour	Beschreibung description	VE unit	Preis/Stange price/unit 270 cm	Preis/Stück price/piece 90 cm	Preis/Stück price/piece 100 cm
STS 44	silber / silver	SCHRÄGPROFIL von 7-15 mm Level-adapting profile for heights 7-15 mm 	10	•	•	•
	sand / sand		10	•	•	•
	gold / gold		10	•	•	•
	bronze / bronze		10	•	•	•
	EO		10	•	•	•
		Edelstahloptik / stainless steel optic				

STS - Schraubsystem 7-15 mm und 15-22 mm - SET inkl. Schrauben und Dübel

STS - Screwing-profile-system for 7-15 mm and 15-22 mm - SET incl. screws and dowels

SERIE 2

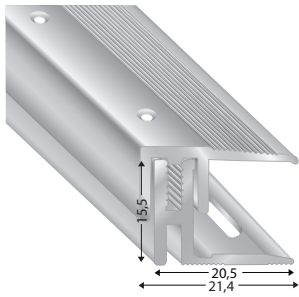

Artikel-Nr. article-no.	Farbe colour	Beschreibung description	VE unit	Preis/Stange price/unit 270 cm	Preis/Stück price/piece 90 cm	Preis/Stück price/piece 100 cm
STS 21 H	silber / silver	ABSCHLUSSPROFIL hoch von 15-22 mm End profile high for heights 15-22 mm	10	•	•	•
	sand / sand		10	•	•	•
	gold / gold		10	•	•	•
	bronze / bronze		10	•	•	•
	EO		10	•	•	•

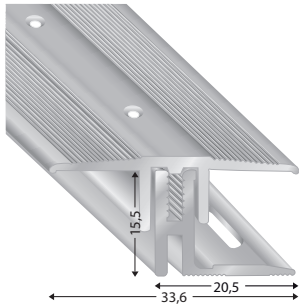

STS 33 H	silber / silver	ÜBERGANGSPROFIL hoch von 15-22 mm Joining profile high for heights 15-22 mm	10	•	•	•
	sand / sand		10	•	•	•
	gold / gold		10	•	•	•
	bronze / bronze		10	•	•	•
	EO		10	•	•	•

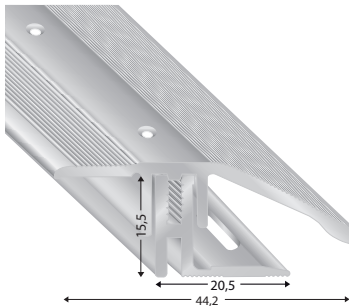

STS 44 H	silber / silver	SCHRÄGPROFIL hoch von 15-22 mm Level-adapting profile high for heights 15-22 mm	10	•	•	•
	sand / sand		10	•	•	•
	gold / gold		10	•	•	•
	bronze / bronze		10	•	•	•
	EO		10	•	•	•

SERIE 3

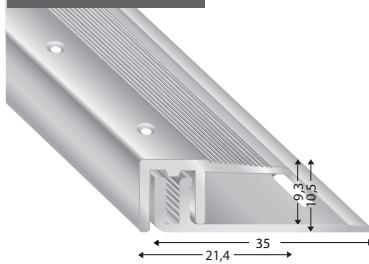

Artikel-Nr. article-no.	Farbe colour	Beschreibung description	VE unit	Preis/Stange price/unit 270 cm	Preis/Stück price/piece 90 cm	Preis/Stück price/piece 100 cm
STS 21 BR	silber / silver	ABSCHLUSSPROFIL breit von 7-15 mm End profile wide for heights 7-15 mm		•	•	•
	sand / sand			•	•	•
	gold / gold			•	•	•
	bronze / bronze			•	•	•
	EO			•	•	•

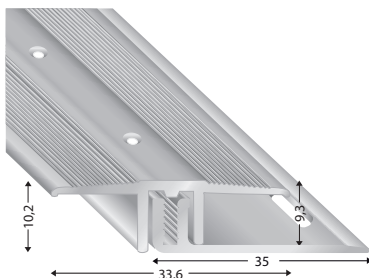

STS 33 BR	silber / silver	ÜBERGANGSPROFIL breit von 7-15 mm Joining profile wide for heights 7-15 mm		•	•	•
	sand / sand			•	•	•
	gold / gold			•	•	•
	bronze / bronze			•	•	•
	EO			•	•	•

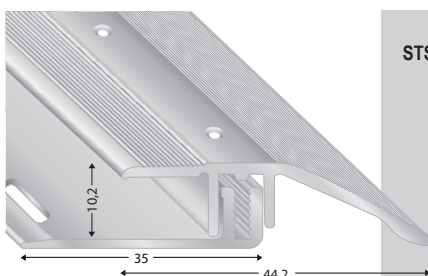

STS 44 BR	silber / silver	SCHRÄGPROFIL breit von 7-15 mm Level adapting profile wide for heights 7-15 mm		•	•	•
	sand / sand			•	•	•
	gold / gold			•	•	•
	bronze / bronze			•	•	•
	EO			•	•	•

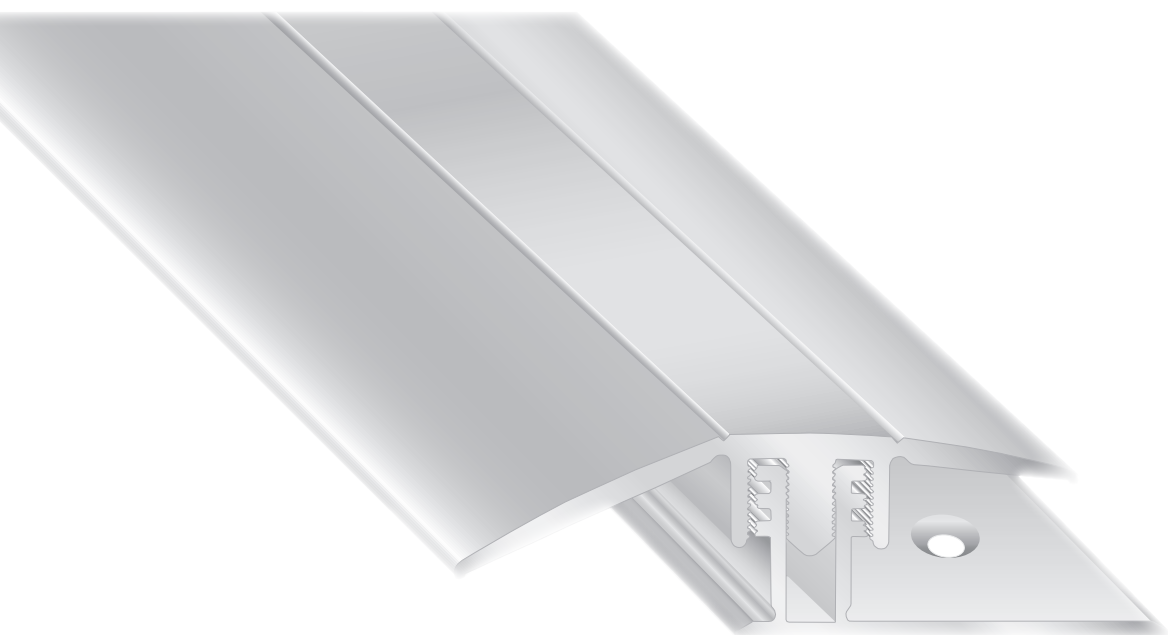

DUO GRIP®

DUO GRIP®

2-teiliges Clipsystem in Aluminium für Laminat und Parkett
2 part clip-system in aluminium for laminate and parquet



DUO GRIP® CLIPSYSTEM in Aluminium für Laminat und Parkett

DECK-, ABSCHLUSS- und ÜBERGANGSPROFILE - zur Verlegung mit Clipsen oder Alu Grundschiene







DUO GRIP® clipsystem in aluminium for laminate and parquet 

COVER-, END- and JOINING PROFILES - installation either with clips or alu base profile

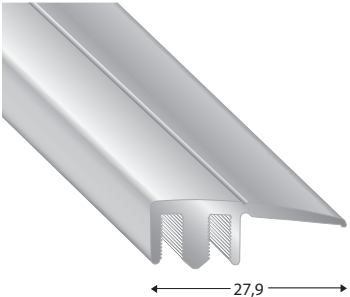

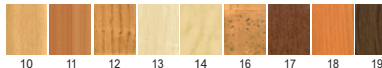
DUO GRIP®



	Artikel-Nr. article-no.	Farbe colour	Beschreibung description	VE unit	Preis/lfm price/lfm 270 cm	Preis/Stück price/piece 90 cm				
	2100	silber / silver	Abschlußprofil - NUR DECKPROFIL End profile - COVER PROFILE ONLY	5	•	•				
		sand / sand	Grundprofil abhängig von Belaghöhe base profile depends on floor-height				5	•	•	
		gold / gold					5	•	•	
		bronze / bronze					5	•	•	
		EO	Edelstahloptik / stainless steel optic				5	•	•	
	8100	HD-Holzdekor wooden decor		5	•	•				
										
	2200	silber / silver	Übergangprofil - NUR DECKPROFIL Joining profile system - COVER PROFILE ONLY	5	•	•				
		sand / sand	Grundprofil abhängig von Belaghöhe base profile depends on floor-height				5	•	•	
		gold / gold					5	•	•	
		bronze / bronze					5	•	•	
		EO	Edelstahloptik / stainless steel optic				5	•	•	
	8200	HD-Holzdekor wooden decor		5	•	•				
										
	2210	silber / silver	Glattes Flachprofil - NUR DECKPROFIL plane flat profile - COVER PROFILE ONLY	5	•	•				
		sand / sand					5	•	•	
		gold / gold					5	•	•	
		bronze / bronze					5	•	•	
		EO	Edelstahloptik / stainless steel optic				5	•	•	
			für Höhen: 8-13 mm mit Grundprofil 4100 8-13 mm with base profile 4100 13-17 mm mit Grundprofil 4200 13-17 mm with base profile 4200 17-22 mm mit Grundprofil 4300 17-22 mm with base profile 4300 22-27 mm mit Grundprofil 4400 22-27 mm with base profile 4400							

DUO GRIP® CLIPSYSTEM in Aluminium für Laminat und Parkett

DECK-, ABSCHLUSS- und ÜBERGANGSPROFILE - zur Verlegung mit Clipsen oder Alu Grundschiene

DUO GRIP® clipsystem in aluminium for laminate and parquet 

COVER-, END- and JOINING PROFILES - installation either with clips or alu base profile



DUO GRIP®

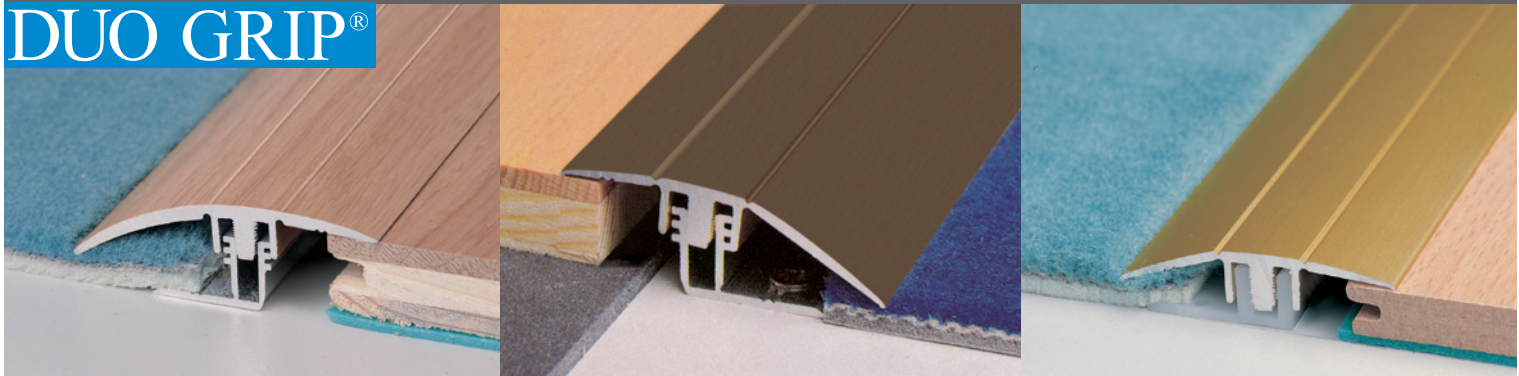

Artikel-Nr. article-no.	Farbe colour	Beschreibung description	VE unit	Preis/lfm price/lfm 270 cm	Preis/Stück price/piece 90 cm
2300	silber / silver	Ausgleichsprofil nieder - NUR DECKPROFIL Level-adapting profile low - COVER PROFILE ONLY Grundprofil abhängig von Belaghöhe base profile depends on floor-height	5	•	•
	sand / sand		5	•	•
	gold / gold		5	•	•
	bronze / bronze		5	•	•
	EO		5	•	•
8300	HD-Holzdekor wooden decor	Edelstahloptik / stainless steel optic	5	•	•
	10		5	•	•
	11				
	12				
	13				
	HD 14				
	HD 16				
	HD 17				
	HD 18				
	HD 19				

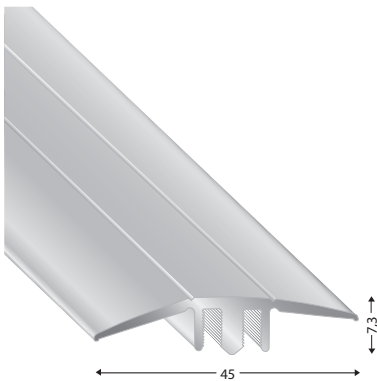

Artikel-Nr. article-no.	Farbe colour	Beschreibung description	VE unit	Preis/lfm price/lfm 270 cm	Preis/Stück price/piece 90 cm
2400	silber / silver	Ausgleichsprofil hoch - NUR DECKPROFIL Level-adapting profile high - COVER PROFILE ONLY Grundprofil abhängig von Belaghöhe base profile depends on floor-height	5	•	•
	sand / sand		5	•	•
	gold / gold		5	•	•
	bronze / bronze		5	•	•
	EO		5	•	•
8400	HD-Holzdekor wooden decor	Edelstahloptik / stainless steel optic	5	•	•
	HD 10		5	•	•
	HD 11				
	HD 12				
	HD 13				
	HD 14				
	HD 16				
	HD 17				
	HD 18				
	HD 19				

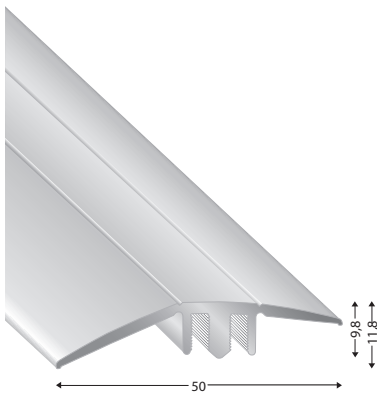

DUO GRIP® CLIPSYSTEM in Aluminium für Laminat und Parkett

ALU-GRUNDPROFILE oder NYLON CLIPSE - versenkt gebohrt

DUO GRIP® clipsystem in aluminium for laminate and parquet





ALU-BASE-PROFILES or NYLON CLIPS - countersunk drilled

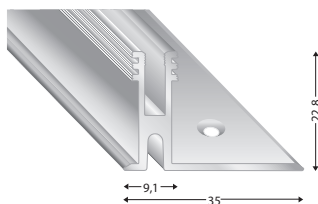
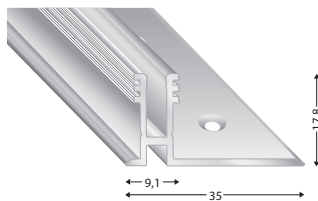
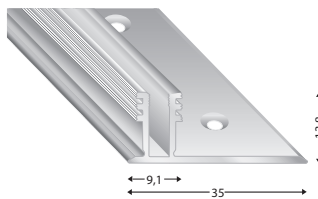
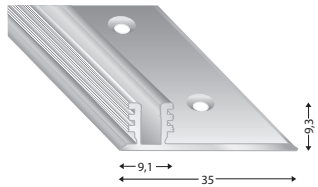

ALU-GRUNDPROFILE

inklusive Befestigungsmaterial
mounting material for base profile included



Artikel-Nr. article-no.	Farbe colour	Beschreibung description	VE unit	Preis/lfm price/lfm 270 cm	Preis/Stück price/piece 90 cm
4100 ROH	roh / raw	für 6-10 mm for 6-10 mm  R = Alu roh / alu raw	5	•	•
4200 ROH	roh / raw	für 10-15 mm for 10-15 mm  R = Alu roh / alu raw	5	•	•
4300 ROH	roh / raw	für 15-19 mm for 15-19 mm  R = Alu roh / alu raw	5	•	•
4400 ROH	roh / raw	für 19-24 mm for 19-24 mm  R = Alu roh / alu raw	5	•	•

CLIPSE

SB verpackte Clips inkl. Schrauben und Dübel
DIY packed clips: screws and dowels included

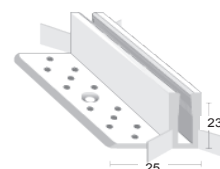
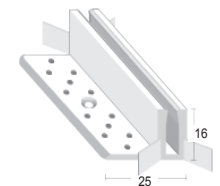
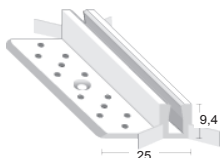

Artikel-Nr. article-no.	Farbe colour	Beschreibung description	VE unit	Preis/Packung price/packing
LC 5104 LC 5112 LC 5150 LC 5110	Clip (Nylon weiß) clip (nylon white)	für 6-10 mm / for 6-10 mm für 6-10 mm / for 6-10 mm für 6-10 mm / for 6-10 mm für 6-10 mm / for 6-10 mm	4 Stk. SB / 4 clips DIY 12 Stk. SB / 12 clips DIY 50 Stk. Krt. / 50 clips box 100 Stk. Krt. / 100 clips box	• • • •
PC 5604 PC 5612 PC 5650 PC 5610	Clip (Nylon weiß) clip (nylon white)	für 10-15 mm / for 10-15 mm für 10-15 mm / for 10-15 mm für 10-15 mm / for 10-15 mm für 10-15 mm / for 10-15 mm	4 Stk. SB / 4 clips DIY 12 Stk. SB / 12 clips DIY 50 Stk. Krt. / 50 clips box 100 Stk. Krt. / 100 clips box	• • • •
PC 5804 PC 5812 PC 5850 PC 5810	Clip (Nylon weiß) clip (nylon white)	für 17-22 mm / for 17-22 mm für 17-22 mm / for 17-22 mm für 17-22 mm / for 17-22 mm für 17-22 mm / for 17-22 mm	4 Stk. SB / 4 clips DIY 12 Stk. SB / 12 clips DIY 50 Stk. Krt. / 50 clips box 100 Stk. Krt. / 100 clips box	• • • •

DUO GRIP® CLIPSYSTEM in Aluminium für Laminat und Parkett

TREPPENKANTE in Aluminium, Deckprofil und Grundprofil - inkl. Nylon-Clipschiene und Befestigungsmaterial

DUO GRIP® clipsystem in aluminium for laminate and parquet

STAIR NOSING in aluminium, cover-profile and base-profile - incl. nylon clip-profile and mounting material

DUO GRIP®

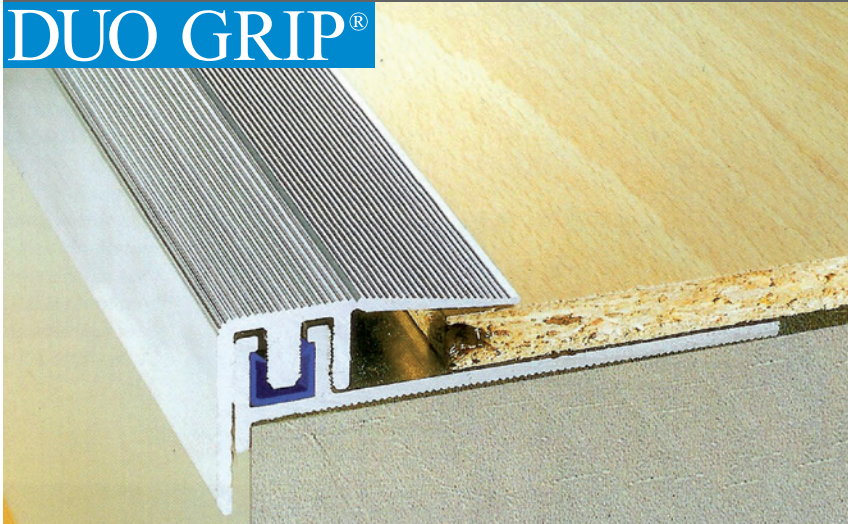

Artikel-Nr. article-no.	Farbe colour	Beschreibung description	VE unit	Preis/lfm price/lfm 270 cm	Preis/Stück price/piece 135 cm
2600	silber / silver	Treppenkante - NUR DECKPROFIL Stair nosing - COVER PROFILE ONLY	5	•	•
	sand / sand	Grundprofil abhängig von Belaghöhe base profile depends on floor-height	5	•	•
	gold / gold		5	•	•
	bronze / bronze		5	•	•
	EO	Edelstahloptik / stainless steel optic	5	•	•

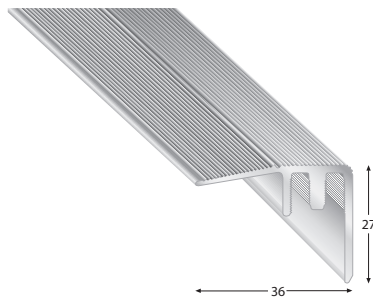

DUO GRIP® - Grundprofile in Aluminium inkl. Nylon Clipschiene - versenkt gebohrt

DUO GRIP® - Base-profiles in aluminium incl. nylon clip-profile - countersunk drilled

inklusive Befestigungsmaterial
mounting material for base profile included

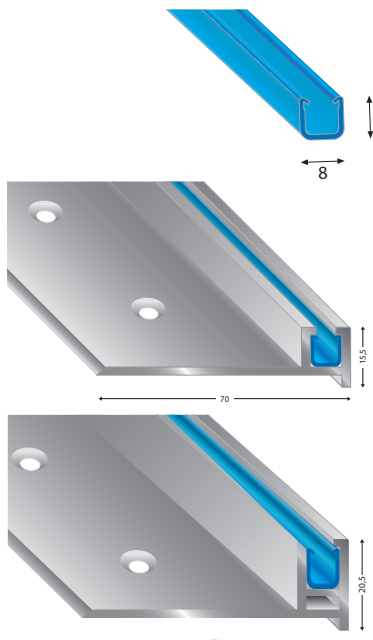

Artikel-Nr. article-no.	Farbe colour	Beschreibung description	VE unit	Preis/lfm price/lfm 270 cm	Preis/Stück price/piece 135 cm
5900	blau / blue	Nylon-Clipschiene nur in Verbindung mit Aluminium Grundprofil 4600, 4700 Nylon-clip profile only to be used with aluminium base-profile 4600, 4700	5	•	•
4600 ROH	roh / raw	Alu Grundprofil roh inkl. Nylon-Clipschiene 5900, Dübel und Schrauben, für Höhen 6-10 mm Alu base-profile raw, incl. nylon-clip profile 5900, screws and dowels, for heights 6-10 mm versenkt gebohrt - countersunk drilled	5	•	•
4700 ROH	roh / raw	Alu Grundprofil roh inkl. Nylon-Clipschiene 5900, Dübel und Schrauben, für Höhen 13-18mm Alu base-profile raw, incl. nylon-clip profile 5900, screws and dowels, for heights 13-18 mm versenkt gebohrt - countersunk drilled	5	•	•

DUO GRIP® CLIPSYSTEM in Aluminium für Laminat und Parkett

ERSATZTEILE - BEFESTIGUNGSMATERIAL

DUO GRIP® clipsystem in aluminium for laminate and parquet

SPARE-PARTS - MOUNTING MATERIAL



RENOVATIONSCLIPS

NEU / NEW

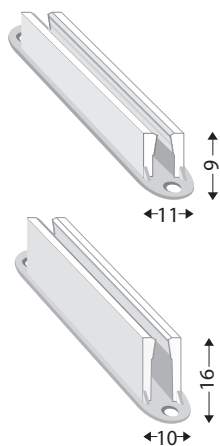

Artikel-Nr. article-no.	Beschreibung description	VE/Stück unit/piece	Preis/VE price/unit
LC 5201	Renovationsclip Clip (POM white) (weiß) zum nachträglichen Einbau for renovation or subsequent installation	1	•
LC 5204	für 6-10 mm / for 6-10 mm	4	•
PC 5701	Renovationsclip Clip (POM white) (weiß) zum nachträglichen Einbau for renovation or subsequent installation	1	•
PC 5704	für 10-15 mm / for 10-15 mm	4	•

Eloxalfarben / anodized colours

HD = Holzdekor / WD = wooden decor

silber silver	sand sand	gold gold	bronze bronze	Edelstahl- optik stainless steel optic	Buche hell 10 light beech	Buche dunkel 11 dark beech	Eiche 12 oak	Esche 13 ash tree	Ahorn 14 maple	Kork 16 cork	Merbau 17 merbau	Kirsche 18 cherry	Walnuss 19 walnut
------------------	--------------	--------------	------------------	---	---------------------------------	----------------------------------	--------------------	-------------------------	----------------------	--------------------	------------------------	-------------------------	-------------------------



DUO GRIP® CLIPSYSTEM in Aluminium für Laminat und Parkett

VERLEGEANLEITUNG - bitte beachten Sie bei der Auswahl des Grundprofils bzw. des Clips die Höhe der Parkettunterlage!

DUO GRIP® clipsystem in aluminium for laminate and parquet

LAYING INSTRUCTION - please take into account the underlay thickness when choosing the dimensions of the aluminium base profile or clips!

Montageanleitung Alu-Grundprofil / Instruction for installation of the aluminium base profile

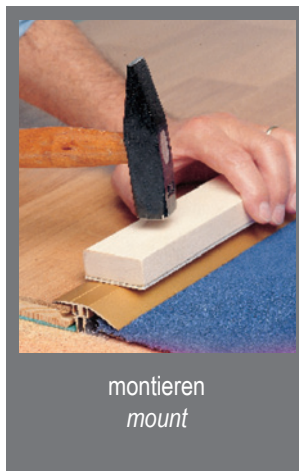

VERLEGEANLEITUNG ALU GRUNDPROFIL

Das gelochte Grundprofil auf dem Unterboden festschrauben oder mit Montagekleber (z.B. POWERGRIP®) festkleben. Laminat oder Parkett anpassen und Dehnfuge beachten! Deckprofil mit einem Hammer (unbedingt Holzklotz verwenden) in das Grundprofil mit Gefühl einschlagen, fertig.

INSTRUCTIONS FOR ASSEMBLY

Screw or glue (with POWERGRIP®) the aluminium base profile to the floor. Tailor the laminate or parquet to fit into the base profile and take care to allow enough room for the necessary expansion of the joint!
Introduce the cover profile into the base with gentle hammer blows, using a block of wood as protection on the cover profile.

Montageanleitung Clips / Instructions for fixing the nylon clips



VERLEGEANLEITUNG CLIP

Sie verwenden das zugeschnittene Deckprofil als Lineal und ziehen eine Linie für die Clipmontage. Clip auf dem Unterboden festschrauben (4 Stück für 80 bis 100 cm) oder mit Montagekleber (z.B. POWERGRIP®) festkleben. Laminat oder Parkett anpassen und Dehnfuge beachten! Deckprofil mit dem Handballen oder mit Hammer und Holzklotz mit Gefühl in den Clipsen fixieren, fertig.

INSTRUCTION FOR ASSEMBLY CLIP

Use the cut-to-size cover profile as a ruler and draw a guideline on the floor for alignment when screwing or glueing the clips. Screw or glue the clips (4 clips per metre) and take care to allow enough room for the necessary expansion of the joint. Tailor the laminate or parquet to fit between the clips. Merely push the cover profile gently into the nylon clips with your hand or introduce the cover profile into the base with gentle hammer blows using a block of wood as protection on the cover profile.

Deckprofil kann als Montagehilfe verwendet werden!
Cover profile can be used as a ruler!

Geprüft an der Technischen Universität Wien.
Quality assured by the Technical University, Vienna.





T-FLEX®

T-FLEX®

Schraubloses Klemmsystem
Screwless clip profile



T-FLEX® Klemmsystem in Aluminium für Laminate und Parkett

ABSCHLUSS-, ÜBERGANGS- und GRUNDPROFILE ...das neue schlanke, schwenkbare und schraublose Klemmsystem

T-FLEX® Clip System in aluminium for laminate and parquet

END-, JOINING- and BASE PROFILES...the all new slim, swivelling and screwless clip system



ÜBERGANGSDECKPROFIL / JOINING PROFILE

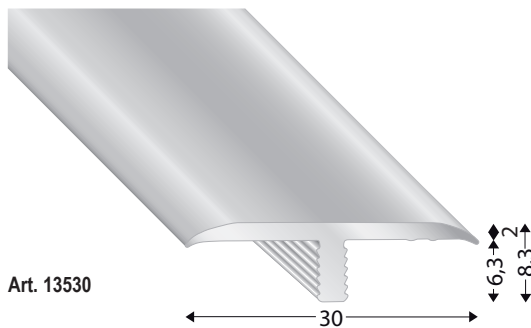

ABSCHLUSSDECKPROFIL / END PROFILE

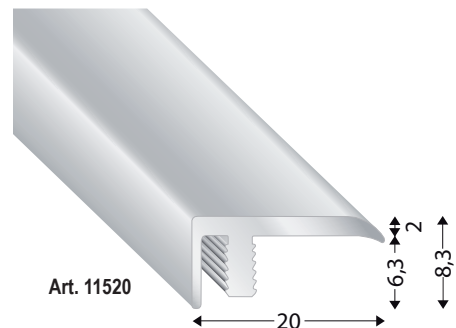

Höhenverstellbar:
high-adjustable:

- ① von 6 - 9 mm
- ② von 8 - 11 mm
- ③ von 11 - 15 mm

NEU! NEW!

Grundprofil/Base profile 4850

Art. 4800

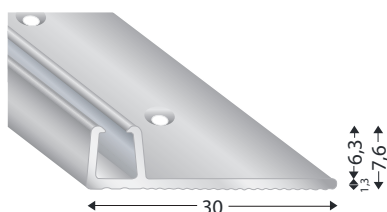

Art. 4850

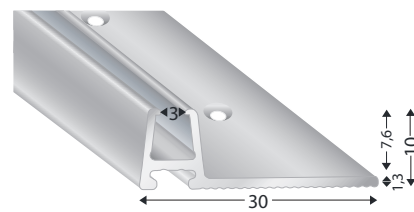

Art. 4900

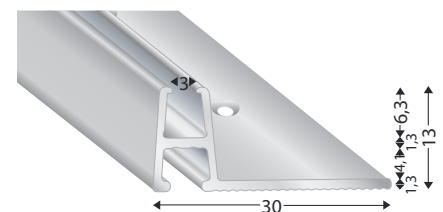

Grundprofil nieder
Base profile low

Grundprofil mittel
Base profile middle

Grundprofil hoch
Base profile high

1

niedrigste Position/gerade
lowest position/flat

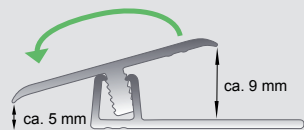
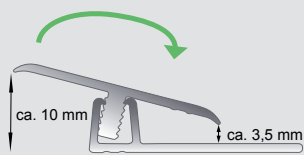
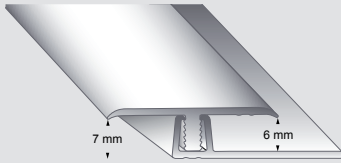

2

niedrigste Position/gerade
lowest position/flat

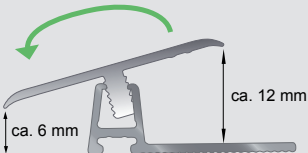
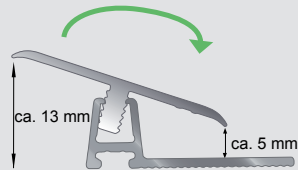
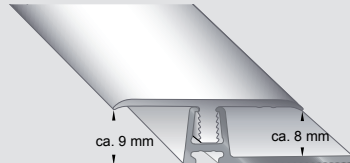

3

niedrigste Position/gerade
lowest position/flat

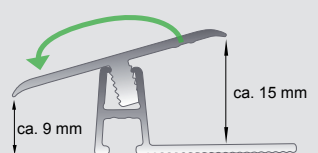
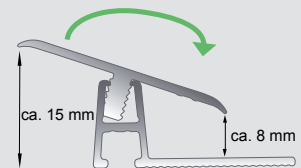
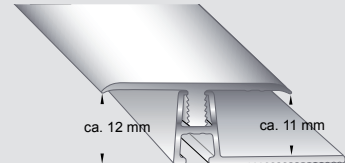

1

höchste Position/gerade
highest position/flat

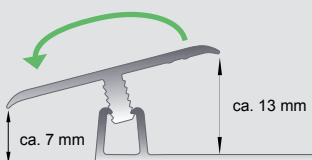
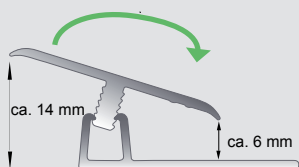
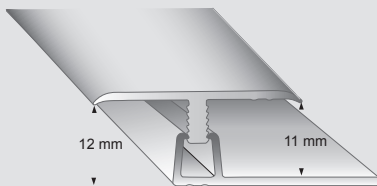

2

höchste Position/gerade
highest position/flat

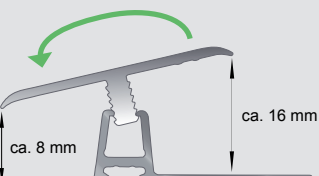
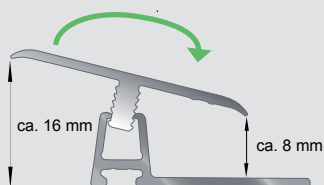
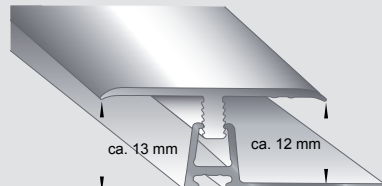

3

höchste Position/gerade
highest position/flat

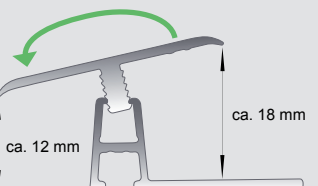
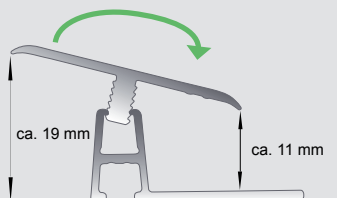
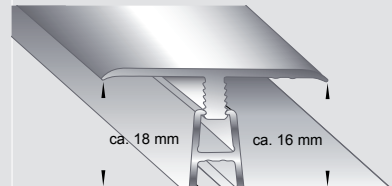

T-FLEX® Klemmsystem in Aluminium für Laminat und Parkett

ABSCHLUSS-, ÜBERGANGS- und GRUNDPROFILE ...das neue schlanke, schwenkbare und schraublose Klemmsystem

T-FLEX® Clip System in aluminium for laminate and parquet

END-, JOINING- and BASEPROFILES...the all new slim, swivelling and screwless clip system

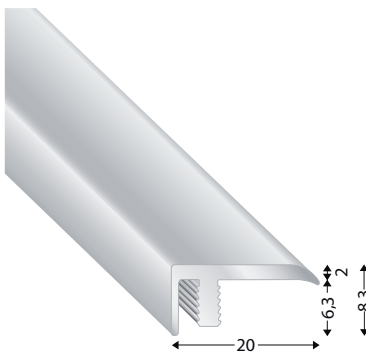
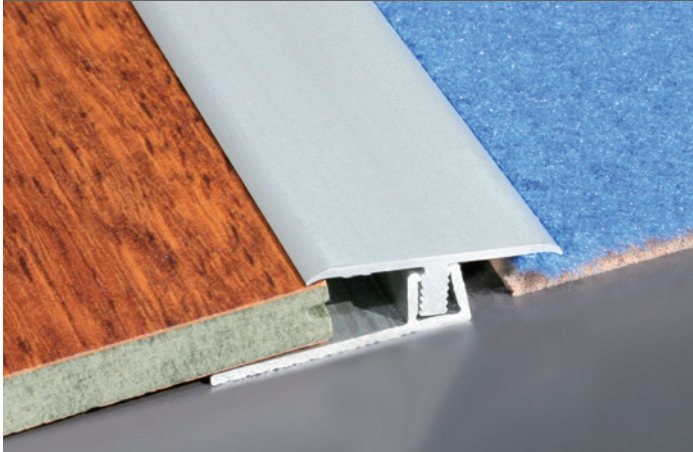

Artikel-Nr. article-no.	Farbe colour	Beschreibung description
11520	silber / silver	Deck-Abschlussprofil - Alu eloxiert <i>End profile anodized aluminium</i>
	sand / sand	Grundprofil abhängig von Belaghöhe <i>base profile depends on floor-height</i>
	gold / gold	
	bronze / bronze	
	EO / EO	Edelstahloptik - stainless steel optic



VE unit	Preis/lfm price/lfm 300 cm	Preis/Stück price/piece 200 cm	Preis/Stück price/piece 100 cm
10	•	•	•
10	•	•	•
10	•	•	•
10	•	•	•
10	•	•	•

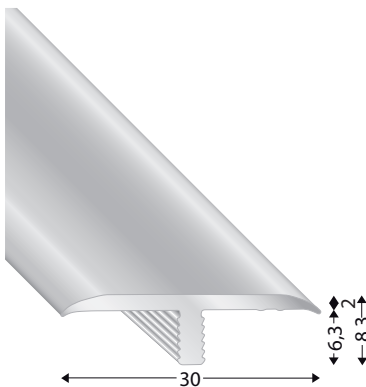

Artikel-Nr. article-no.	Farbe colour	Beschreibung description
13530	silber / silver	Deck-Übergangprofil - Alu eloxiert <i>Joining profile anodized aluminium</i>
	sand / sand	Grundprofil abhängig von Belaghöhe <i>base profile depends on floor-height</i>
	gold / gold	
	bronze / bronze	
	EO / EO	Edelstahloptik - stainless steel optic



VE unit	Preis/lfm price/lfm 300 cm	Preis/Stück price/piece 200 cm	Preis/Stück price/piece 100 cm
10	•	•	•
10	•	•	•
10	•	•	•
10	•	•	•
10	•	•	•

T-FLEX® Klemmsystem in Aluminium für Laminat und Parkett

ABSCHLUSS-, ÜBERGANGS- und GRUNDPROFILE ...das neue schlanke, schwenkbare und schraublose Klemmsystem

T-FLEX® Clip System in aluminium for laminate and parquet

END-, JOINING- and BASEPROFILES...the all new slim, swivelling and screwless clip system

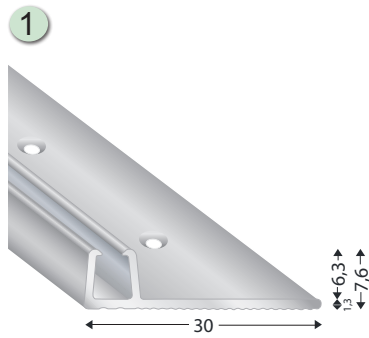
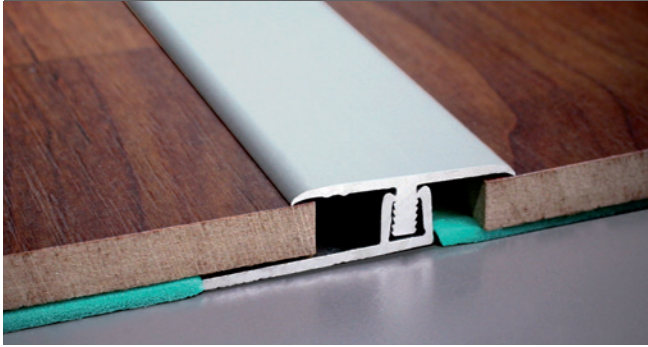

Artikel-Nr. article-no.	Farbe colour	Beschreibung description
4800	roh / raw	Grundprofil nieder für 11520 + 13530 Base profile low for 11520 + 13530 versenkt gebohrt - countersunk drilled von 6-9 mm - inkl. Schrauben und Dübel for 6-9 mm - incl. screws and dowels

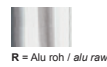

R = Alu roh / alu raw

VE unit	Preis/lfm price/lfm 300 cm	Preis/Stück price/piece 200 cm	Preis/Stück price/piece 100 cm
10	•	•	•

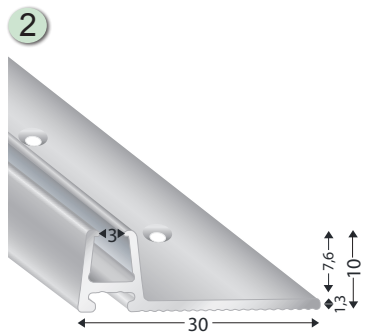

Artikel-Nr. article-no.	Farbe colour	Beschreibung description
4850	roh / raw	Grundprofil hoch für 11520 + 13530 Base profile high for 11520 + 13530 versenkt gebohrt - countersunk drilled von 8-11 mm - inkl. Schrauben und Dübel for 8-11 mm - incl. screws and dowels

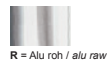

R = Alu roh / alu raw

VE unit	Preis/lfm price/lfm 300 cm	Preis/Stück price/piece 200 cm	Preis/Stück price/piece 100 cm
10	•	•	•

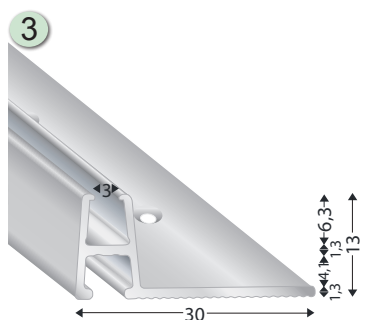

Artikel-Nr. article-no.	Farbe colour	Beschreibung description
4900	roh / raw	Grundprofil hoch für 11520 + 13530 Base profile high for 11520 + 13530 versenkt gebohrt - countersunk drilled von 11-15 mm - inkl. Schrauben und Dübel for 11-15 mm - incl. screws and dowels

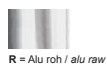

R = Alu roh / alu raw

VE unit	Preis/lfm price/lfm 300 cm	Preis/Stück price/piece 200 cm	Preis/Stück price/piece 100 cm
10	•	•	•



SOLUM

NEU / NEW

SOLUM

2-teiliges Schraubsystem -
vertikal verstellbar, schwenkbar, mit **nur** einem Grundprofil!

*2-part screwing system -
vertically adjustable, swivelling, with just **one** base profile!*



2-teiliges Schraubensystem - vertikal verstellbar, schwenkbar, mit nur einem Grundprofil von 7-16,5 mm - SET inkl. TORX-Schrauben und Dübel
ABSCHLUSS-, ÜBERGANGS- und AUSGLEICHPROFIL ...

2-part - screwing system vertically adjustable, swivelling, with just one base profile from 7-16,5 mm - SET incl. torx-screw and dowels
END-, JOINING- and LEVEL ADAPTING PROFILE...

NEU / NEW



Artikel-Nr. article-no.	Farbe colour	Beschreibung description	VE unit	Preis/Stange price/unit 270 cm	Preis/Stück price/piece 100 cm
A79127 20	silber / silver	Abschlussprofil von 7 - 16,5 mm - Alu eloxiert End profile for 7 - 16,5 mm - anodized aluminium	10	•	•
A79127 25	sand / sand		10	•	•
A79127 30	gold / gold		10	•	•
A79127 40	bronze / bronze		10	•	•
A79127 15	EO / EO	Edelstahl optik - stainless steel optic	10	•	•



A79125 20	silber / silver	Übergangprofil von 7 - 16,5 mm - Alu eloxiert Joining profile for 7 - 16,5 mm - anodized aluminium	10	•	•
A79125 25	sand / sand		10	•	•
A79125 30	gold / gold		10	•	•
A79125 40	bronze / bronze		10	•	•
A79125 15	EO / EO	Edelstahl optik - stainless steel optic	10	•	•

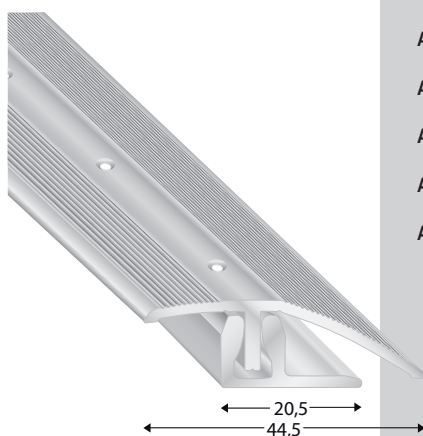

A79129 20	silber / silver	Ausgleichprofil von 7 - 16,5 mm - Alu eloxiert Level adapting profile for 7 - 16,5 mm - anodized aluminium	10	•	•
A79129 25	sand / sand		10	•	•
A79129 30	gold / gold		10	•	•
A79129 40	bronze / bronze		10	•	•
A79129 15	EO / EO	Edelstahl optik - stainless steel optic	10	•	•

2-teiliges Schraubsystem -
vertikal verstellbar, schwenkbar, mit nur einem Grundprofil von 7-16,5 mm

2-part - screwing system
vertically adjustable, swivelling, with just one base profile from 7-16,5 mm



ÜBERGANGSPROFIL - bis zu 8 mm schwenkbar
JOINING PROFILE - swivelling to 8 mm

AUSGLEICHSPROFIL - bis zu 10 mm schwenkbar
LEVEL ADAPTING PROFILE - swivelling to 10 mm

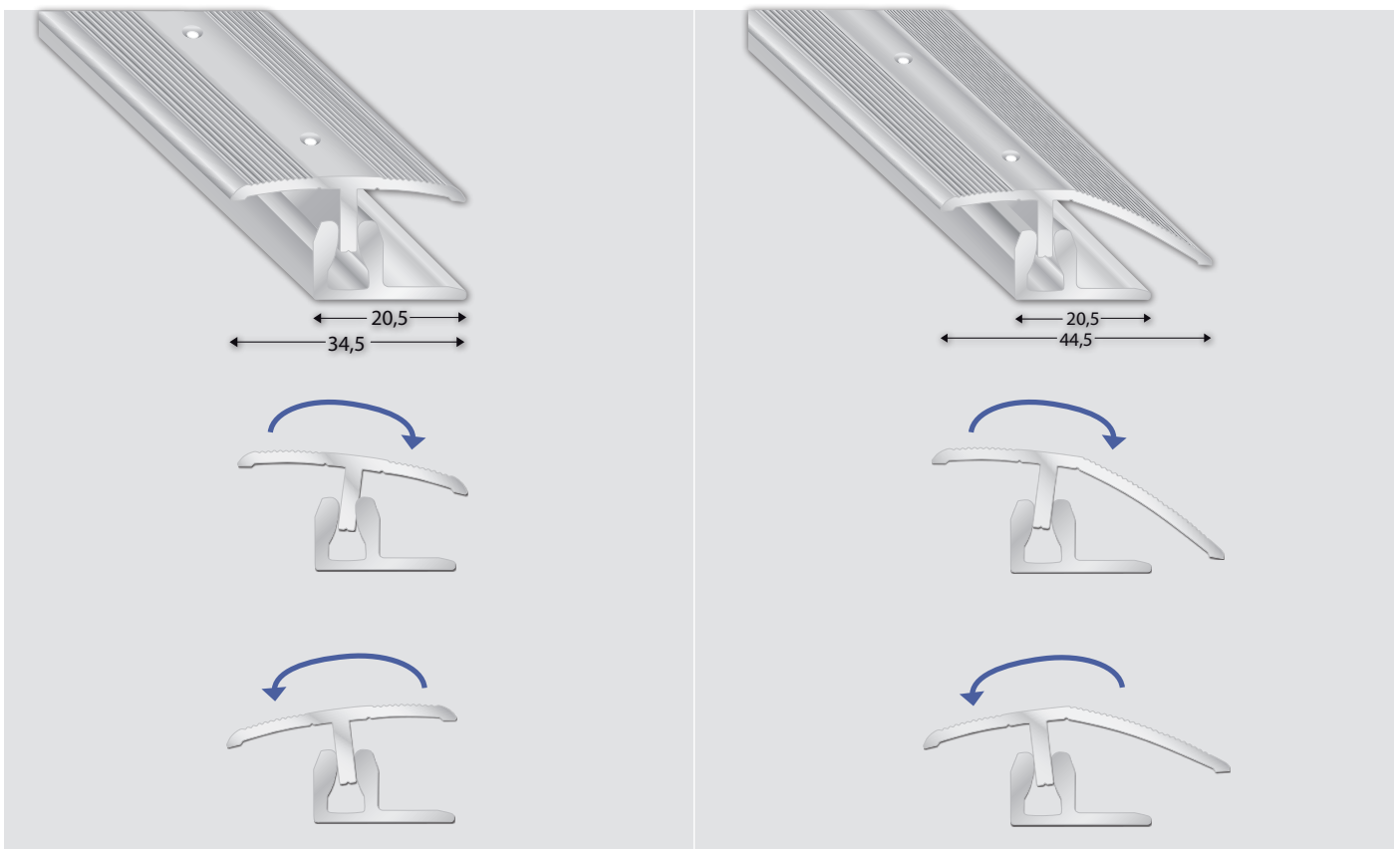



RENOPROFILE

NEU / NEW

RENO

TREPPEN Renovierungsprofile
Stair renovations profiles



Treppen Renovierungsprofil - RENO

TREPPENKANTENPROFIL

Stair renovations profiles - RENO

STAIR NOSINGS ROFILES

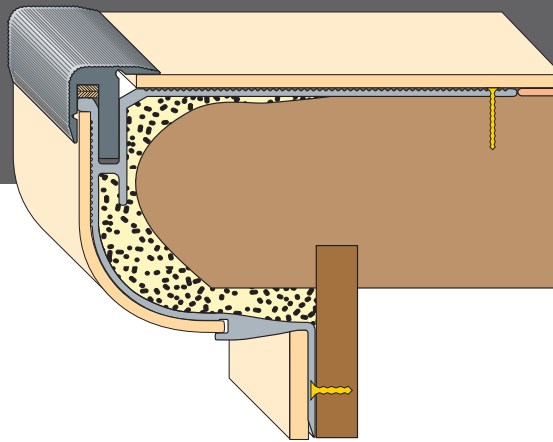

Stabiler Verblendeschenkel - gerundet
 Neue Frontblende aus Belagstreifen
 - kein Holz
 Aufnahmebohrung für Frontblende bis
 max. 3,2 mm Stärke
 Verlängerung des Verblendeschenkels

NEU / NEW

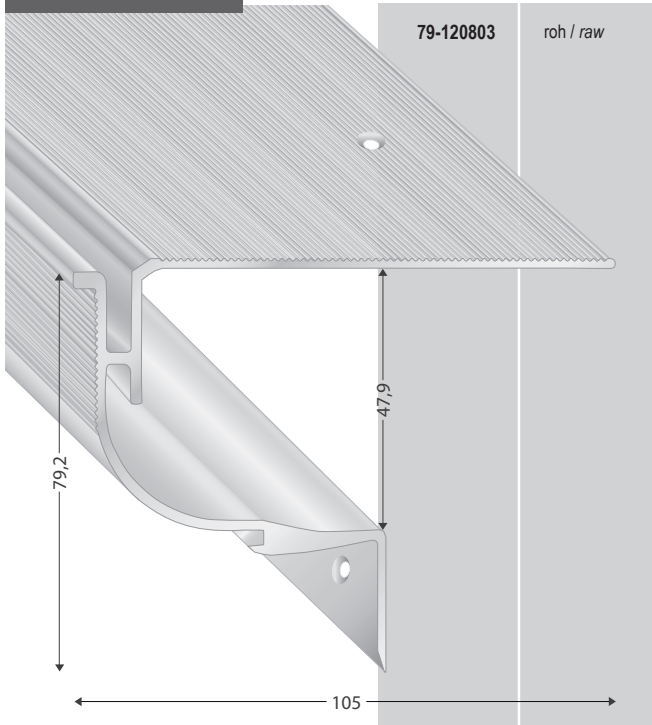

Artikel-Nr.
article-no.

Farbe
colour

Beschreibung
description

VE
unit

Preis/lfm
price/lfm
270 cm

Preis/lfm
price/unit
200 cm

79-120803

roh / raw

RENO-Grundprofil „All in One“
RENO-base profile „All in One“

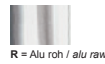

5

•

•

Artikel-Nr.
article-no.

Farbe
colour

Beschreibung
description

VE
unit

Preis/lfm
price/lfm
270 cm

Preis/lfm
price/unit
200 cm

79-010121

silber / silver

RENO-Kopfprofil Alu für Grundprofil „All in One“
RENO-profile alu for base profile „All in One“

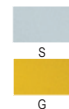

5

•

•

79-010122

gold / gold

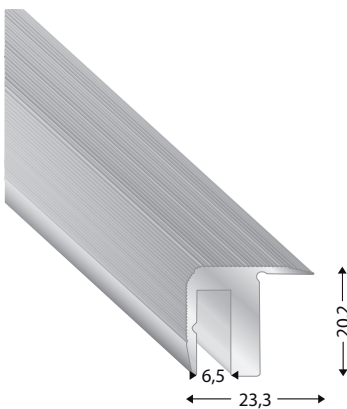

5

•

•

TREPPENRENOVIERUNG

Reno Profil

ALL IN ONE

... für eine anspruchsvolle Treppenrenovierung!

ALL IN ONE – das etwas andere Treppenrenovierungsprofil

Ein Profil für alle Treppenbeläge von 2 - 8 mm Dicke.

Sie können wählen:

Basisprofil	<ul style="list-style-type: none">• Mit gerundeter Vorderkante• In der Ausführung „Stabil“
Kopfprofil	<ul style="list-style-type: none">• Aluminium eloxiert oder pulverbeschichtet• Hartholz: Viele Holzarten stehen zur Verfügung. (Nicht emp. bei Mietobjekten)

Abb. zeigt eine Variante des **RenoProfil** „All in One“ Stabil „RUNDKANTE“

Stabiler Verblendeschenkel - gerundet
Neue Frontblende aus Belagstreifen - **kein** Holz
Aufnahmetasche für Frontblende bis max. 3,2 mm Stärke
Verlängerung des Verblendeschenkels

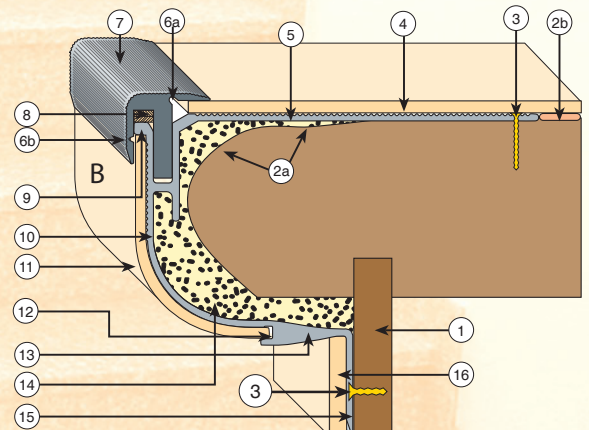

Treppen Renovierungsprofil - RENO

TREPPENKANTENPROFIL

Stair renovations profiles - RENO

STAIR NOSINGS ROFILES

NEU / NEW

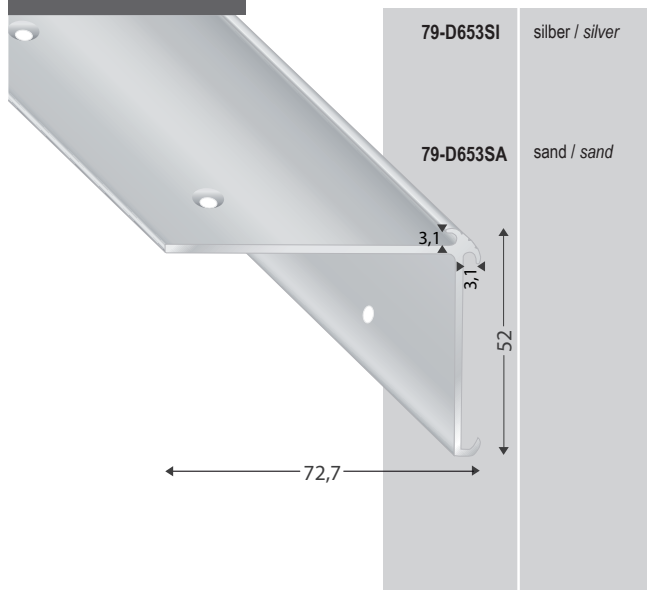

Artikel-Nr.
article-no.

Farbe
colour

Beschreibung
description

VE
unit

Preis/lfm
price/lfm
270 cm

79-D653SI

silber / silver

Treppen-Renovierungsprofil „Design-Standard“
Stairnosings-renovationsprofiles „Design-Standard“

5

•

79-D653SA

sand / sand

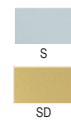

5

•

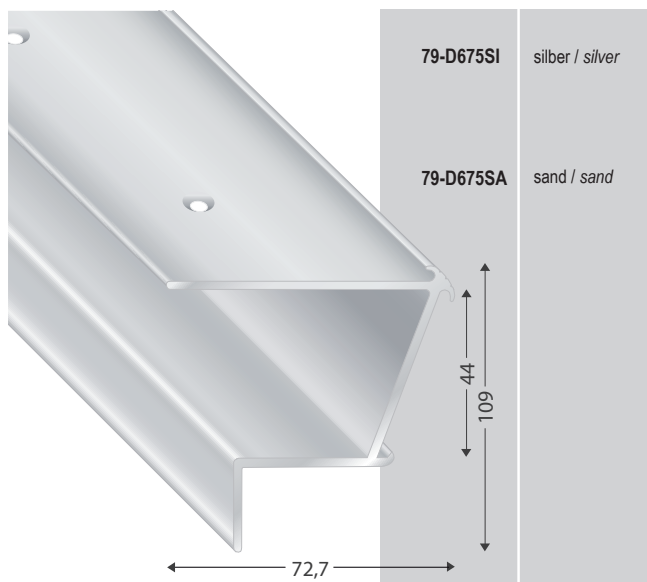

Artikel-Nr.
article-no.

Farbe
colour

Beschreibung
description

VE
unit

Preis/lfm
price/lfm
270 cm

79-D675SI

silber / silver

Treppen-Renovierungsprofil „Design-Stabil“
Stairnosings-renovationsprofiles „Design-Stabil“

5

•

79-D675SA

sand / sand

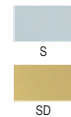

5

•

Treppen Renovierungsprofil - RENO

TREPPENKANTENPROFIL

Stair renovations profiles - RENO

STAIR NOSINGS ROFILES

NEU / NEW

NEU / NEW	Artikel-Nr. article-no.	Farbe colour	Beschreibung description	VE unit	Preis/lfm price/lfm 270 cm
	79-110851	silber / silver	Treppen-Renovierungsprofil RENO „8,5 mm Standard“ Stairnosings-renovationsprofile Reno „8,5 mm Standard“	5	•
	79-110850	gold / gold		5	•
	79-132501	silber / silver	Treppen-Renovierungsprofil RENO „Multiversal“ Stairnosings-renovationsprofile Reno „Multiversal“	5	•
	79-13250	gold / gold		5	•
	79-120851	silber / silver	Treppen-Renovierungsprofil RENO „8,5 mm Stabil“ Stairnosings-renovationsprofile Reno „8,5 mm Stabil“	5	•
	79-120850	gold / gold		5	•



SCHLAGDÜBELSYSTEM

NEU / NEW

SCHLAGDÜBEL SYSTEM

Schraubloses Klemmsystem

DOWEL SYSTEM

Screwless clip profile

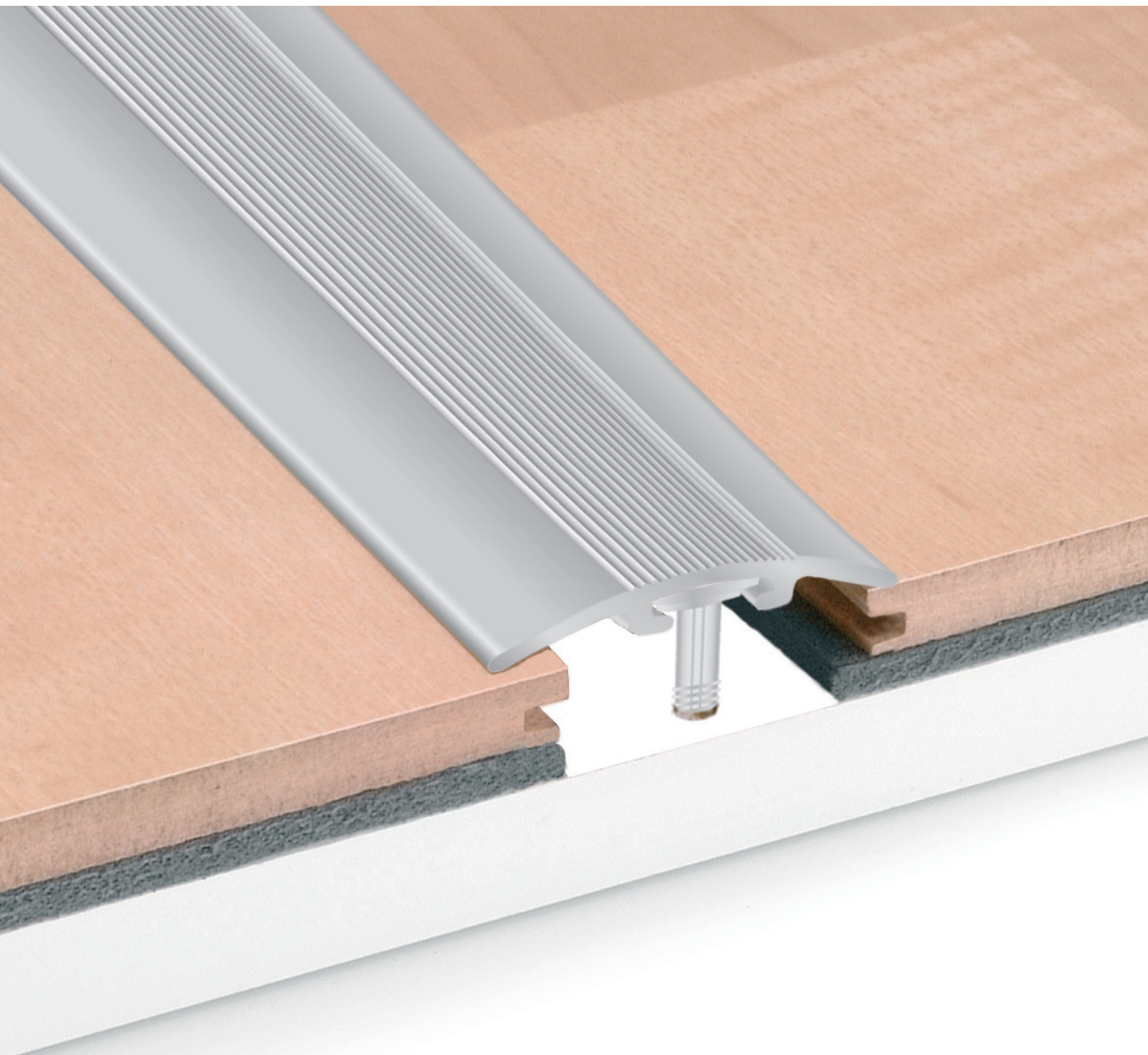

Schlagdübel System in Aluminium für Laminat und Parkett ÜBERGANGS- und AUSGLEICHSPROFILE

Clip System in aluminium for laminate and parquet JOINING- and LEVEL ADAPTING PROFILES

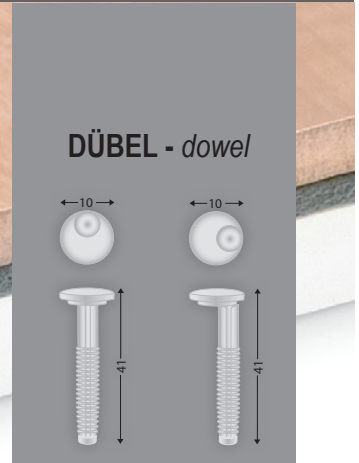
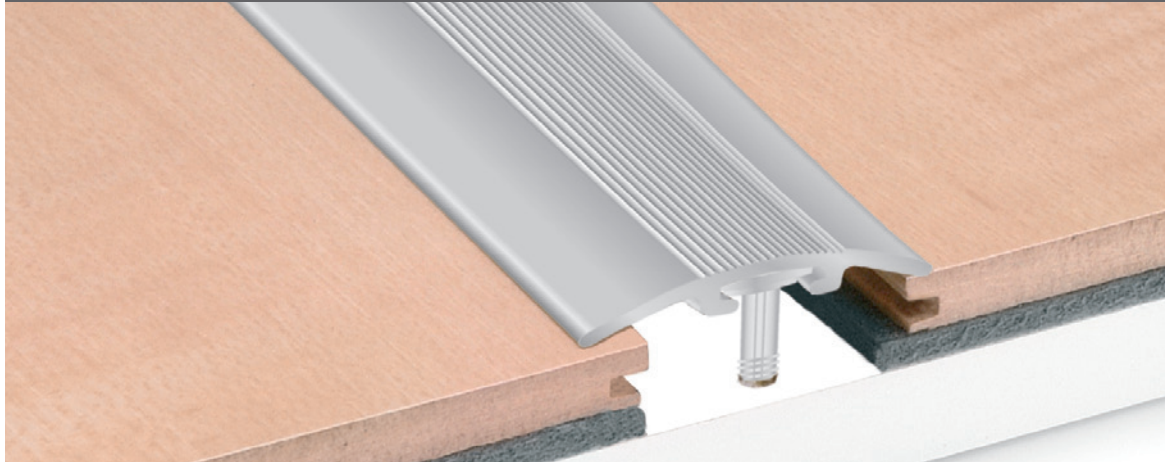

NEU / NEW

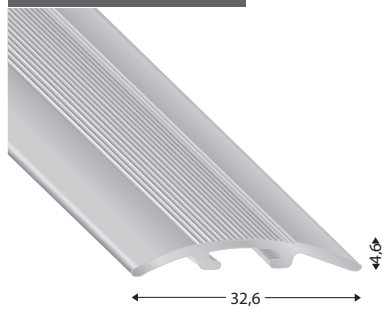

Artikel-Nr. article-no.	Farbe colour	Beschreibung description	VE unit	Preis/Stange price/unit 270 cm	Preis/Stück price/piece 100 cm
PS32 S	silber / silver	Übergangprofil ungebohrt bis 13 mm Parkett Joining profiles undrilled for about up to 13 mm parquet	10	•	•
PS32 S 100					
PS32 SD	sand / sand		10	•	•
PS32 SD 100					
PS32 G	gold / gold		10	•	•
PS32 G 100					
PS32 B	bronze / bronze		10	•	•
PS32 B 100					
PS32 EO	EO	Edelstahloptik / stainless steel optic	10	•	•
PS32 EO 100					

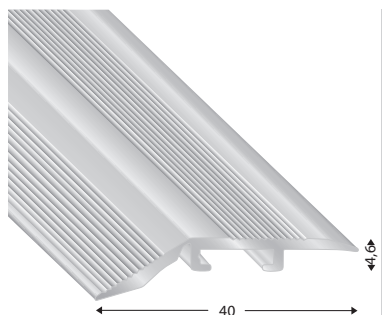

PS40 S	silber / silver	Ausgleichsprofil ungebohrt bis 13 mm Parkett Level adapting profile undrilled for about up to 13 mm parquet	10	•	•
PS40 S 100					
PS40 SD	sand / sand		10	•	•
PS40 SD 100					
PS40 G	gold / gold		10	•	•
PS40 G 100					
PS40 B	bronze / bronze		10	•	•
PS40 B 100					
PS40 EO	EO	Edelstahloptik / stainless steel optic	10	•	•
PS40 EO 100					

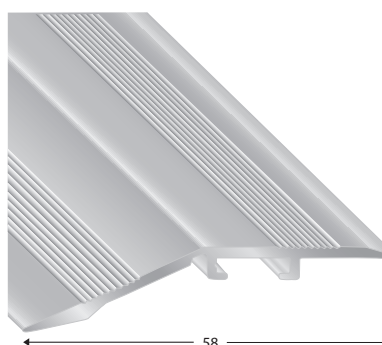

PS58 S	silber / silver	Ausgleichsprofil ungebohrt bis 13 mm Parkett Level adapting profile undrilled for about up to 13 mm parquet	10	•	•
PS58 S 100					
PS58 SD	sand / sand		10	•	•
PS58 SD 100					
PS58 G	gold / gold		10	•	•
PS58 G 100					
PS58 B	bronze / bronze		10	•	•
PS58 B 100					
PS58 EO	EO	Edelstahloptik / stainless steel optic	10	•	•
PS58 EO 100					

2-teiliges Treppenkantenprofil in Aluminium für Laminate und Parkett TREPPENKANTENPROFIL

2-part stairnose profile in aluminium for laminate and parquet
STAIR NOSINGS PROFILE

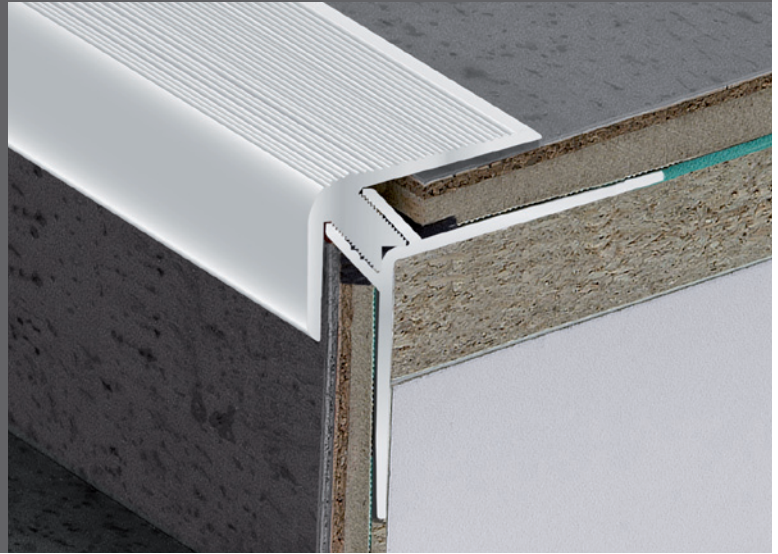

NEU / NEW

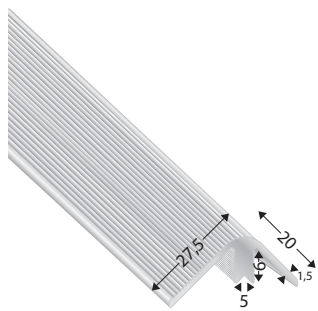

Artikel-Nr.
article-no.

Farbe
colour

Beschreibung
description

VE
unit

Preis/lfm
price/lfm
300 cm

2650

silber / silver

Treppenkante
Stair nosings profile

5

•

sand / sand



5

•

gold / gold

Edelstahl optik / stainless steel optic



5

•

bronze / bronze

5

•

EO

5

•

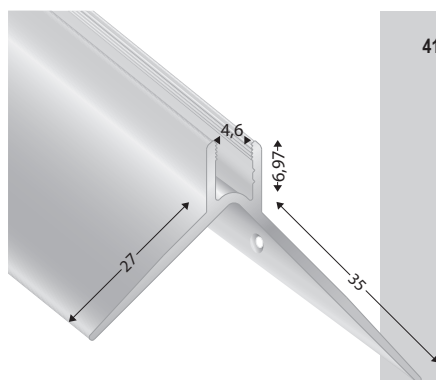

4150

roh / raw

Grundprofil nieder zu Art. 2650
Höhe von 7-10 mm
Base profile low
heights 7-10 mm

5

•

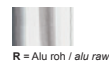

R = Alu roh / alu raw

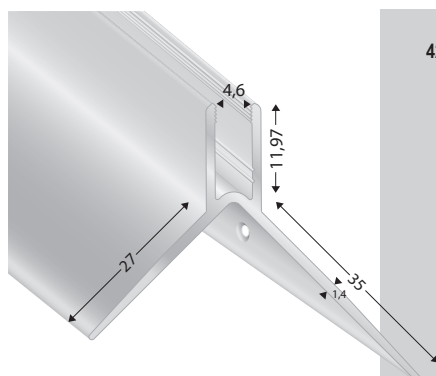

4250

roh / raw

Grundprofil hoch zu Art. 2650
Höhe von 10-14 mm
Base profile high
heights 10-14 mm

5

•

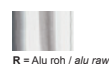

R = Alu roh / alu raw

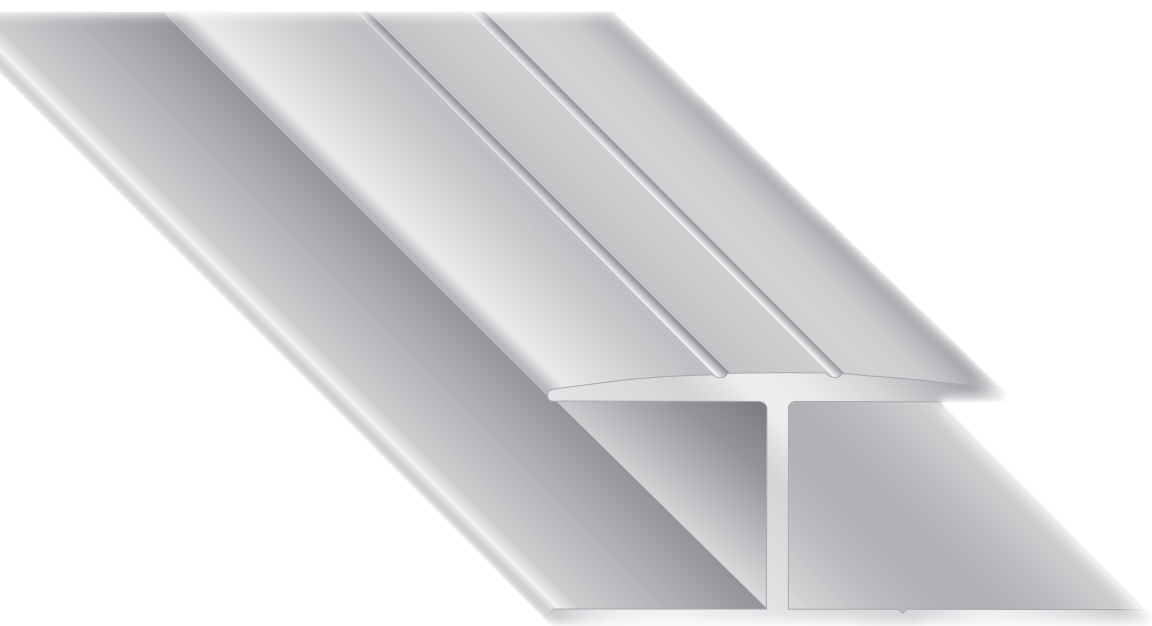

MONOPROFILE

MONOPROFILE

Einteilige Laminat und Parkettprofile in Aluminium eloxiert
oder mit Holzdekor

*One-piece profiles in aluminium for laminate and parquet anodized
or with wooden decor*



MONOPROFILE in Aluminium und Edelstahl für Laminat und Parkett

ABSCHLUSSPROFILE - einteilig, eloxiert oder Holzdekor - NEU: mit Soll-Knickstelle!

MONOPROFILES in aluminium and stainless steel for laminate and parquet

END PROFILES - one piece, anodized or with wooden decor - with level accommodating groove!



NEU / NEW

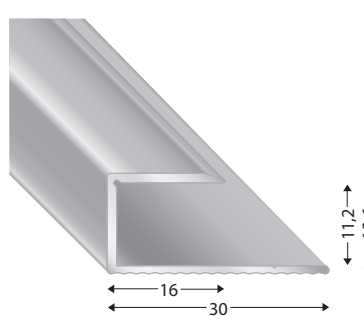
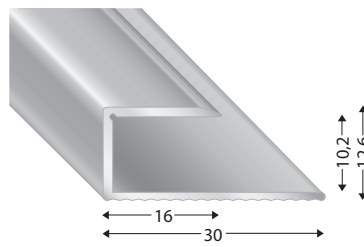
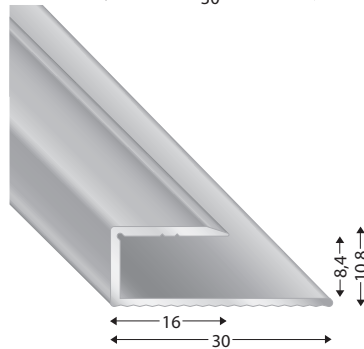
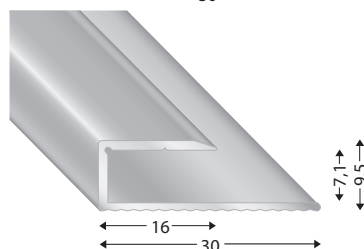
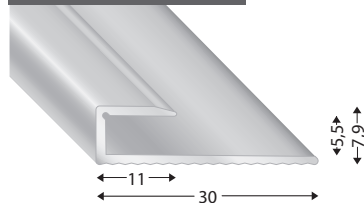

Artikel-Nr. article-no.	Farbe colour	Beschreibung description	VE unit	Preis/lfm price/lfm 270 cm	Preis/Stück price/piece 100 cm	Preis/Stück price/piece 90 cm
11055	silber / silver	ungebohrt für ca. 5,5 mm Laminat undrilled for about 5,5 mm laminate S SD G B EO	10	•	•	
	sand / sand		10	•	•	
	gold / gold		10	•	•	
	bronze / bronze		10	•	•	
	EO / EO		10	•	•	
11070	silber / silver	ungebohrt für ca. 7 mm Laminat undrilled for about 7 mm laminate S SD G B Edelstahl / stainless steel optic EO	10	•	•	
	sand / sand		10	•	•	
	gold / gold		10	•	•	
	bronze / bronze		10	•	•	
	EO / EO		10	•	•	
11080	silber / silver	ungebohrt für ca. 7-8 mm Laminat undrilled 7-8 mm laminate S SD G B E = Edelstahl / stainless steel Edelstahl / stainless steel optic EO	10	•	•	
	sand / sand		10	•	•	
	gold / gold		10	•	•	
	bronze / bronze		10	•	•	
	Edelstahl / stainless steel		10		• (250 cm)	
	EO / EO		10	•	•	
11100	silber / silver	ungebohrt für ca. 10 mm Laminat / Parkett undrilled for about 10 mm laminate / parquet S SD G B Edelstahl / stainless steel optic EO	10	•	•	
	sand / sand		10	•	•	
	gold / gold		10	•	•	
	bronze / bronze		10	•	•	
	EO / EO		10	•	•	
11110	silber / silver	ungebohrt für ca. 10-11 mm Laminat/Parkett undrilled for about 10-11 mm laminate/parquet S SD G B Edelstahl / stainless steel optic EO	10	•	•	
	sand / sand		10	•	•	
	gold / gold		10	•	•	
	bronze / bronze		10	•	•	
	EO / EO		10	•	•	
	HD / wooden decor		10	•	•	

MONOPROFILE in Aluminium und Edelstahl für Laminat und Parkett

ABSCHLUSSPROFILE - einteilig, eloxiert oder Holzdekor

MONOPROFILES in aluminium and stainless steel for laminate and parquet

END PROFILES - one piece, anodized or with wooden decor - with level accommodating groove!

	Artikel-Nr. article-no.	Farbe colour	Beschreibung description	VE unit	Preis/lfm price/lfm 270 cm	Preis/Stück price/piece 100 cm	Preis/Stück price/piece 90 cm	
	11120	silber / silver	ungebohrt für ca. 12 mm Parkett undrilled for about 12 mm parquet 	10	•	•		
		sand / sand		10	•	•		
		gold / gold		10	•	•		
		bronze / bronze		10	•	•		
	11130	silber / silver	ungebohrt für ca. 13 mm Parkett undrilled for about 13 mm parquet 	10	•	•		
		sand / sand		10	•	•		
		gold / gold		10	•	•		
		bronze / bronze		10	•	•		
	11140	silber / silver	ungebohrt für ca. 14 mm Parkett undrilled for about 14 mm parquet 	10	•	•		
		sand / sand		10	•	•		
		gold / gold		10	•	•		
		bronze / bronze		10	•	•		
		EO / EO	Edelstahloptik / stainless steel optic	 EO	10	•	•	
	11150	silber / silver	ungebohrt für ca. 15 mm Parkett undrilled for about 15 mm parquet 	10	•	•		
		sand / sand		10	•	•		
		gold / gold		10	•	•		
		bronze / bronze		10	•	•		
		Edelstahl/ stainless steel		 E = Edelstahl / stainless steel	10		•	
		EO / EO		Edelstahloptik / stainless steel optic	 EO	10	•	•
HD / wooden decor	 10 11 12 13 14 16 17 18	10	•		•			
	11180	silber / silver	ungebohrt für ca. 18 mm Parkett undrilled for about 18 mm parquet 	10	•			
		sand / sand		10	•			
		gold / gold		10	•			
		bronze / bronze		10	•			
	11220	silber / silver	ungebohrt für ca. 22 mm Parkett undrilled for about 22 mm parquet 	10	•			
		sand / sand		10	•			
		gold / gold		10	•			
		bronze / bronze		10	•			

MONOPROFILE in Aluminium für Laminate und Parkett

ABSCHLUSSPROFILE - einteilig, eloxiert

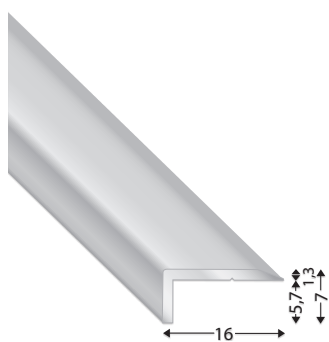

MONOPROFILES in aluminium for laminate and parquet

END PROFILES - one piece, anodized



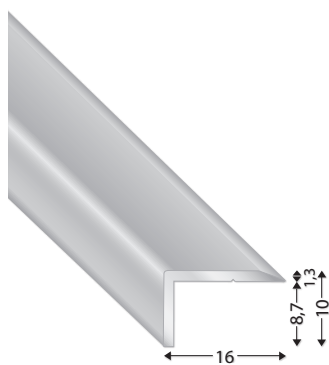

Artikel-Nr. article-no.	Farbe colour	Beschreibung description	VE unit	Preis/lfm price/lfm 270 cm
16070	silber / silver	ungebohrt ab 7 x 16 x 1,3 mm undrilled from 7 x 16 x 1,3 mm 	10	•

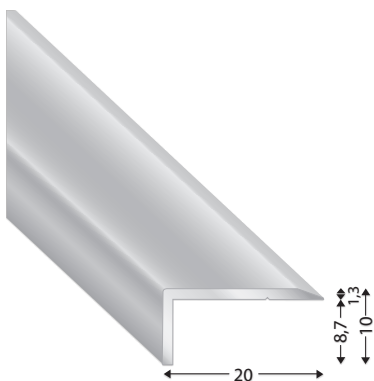

16100	silber / silver	ungebohrt ab 10 x 16 x 1,3 mm undrilled from 10 x 16 x 1,3 mm 	10	•
	EO / EO	Edelstahl optik / stainless steel optic 	10	•



16120	silber / silver	ungebohrt ab 10 x 20 x 1,3 mm undrilled from 10 x 20 x 1,3 mm 	10	•
	EO / EO	Edelstahl optik / stainless steel optic 	10	•

MONOPROFILE in Aluminium für Laminat und Parkett

ÜBERGANGSPROFILE - einteilig, eloxiert oder Holzdekor

MONOPROFILES in aluminium for laminate and parquet

JOINING PROFILES - one piece, anodized or with wooden decor



	Artikel-Nr. article-no.	Farbe colour	Beschreibung description	VE unit	Preis/lfm price/lfm 270 cm	Preis/Stück price/piece 90 cm
	12070	silber / silver	ungebohrt für ca. 7 mm Laminat undrilled for about 7 mm laminate 	10	•	•
		sand / sand		10	•	•
		gold / gold		10	•	•
		bronze / bronze		10	•	•
	12080	silber / silver	ungebohrt für ca. 7-8 mm Laminat undrilled for about 7-8 mm laminat 	10	•	•
		sand / sand		10	•	•
		gold / gold		10	•	•
		bronze / bronze		10	•	•
		EO / EO	10	•	•	
		HD / wooden decor	10	•	•	
	12110	silber / silver	ungebohrt für ca. 10-11 mm Laminat/Parkett undrilled for about 10-11 mm laminat/parquet 	10	•	•
		sand / sand		10	•	•
		gold / gold		10	•	•
		bronze / bronze		10	•	•
		EO / EO		10	•	•
	12140	silber / silver	ungebohrt für ca. 13-14 mm Parkett undrilled for about 13-14 mm parquet 	10	•	•
		sand / sand		10	•	•
		gold / gold		10	•	•
		bronze / bronze		10	•	•
	12150	silber / silver	ungebohrt für ca. 14-15 mm Parkett undrilled for about 14-15 mm parquet 	10	•	•
		sand / sand		10	•	•
		gold / gold		10	•	•
		bronze / bronze		10	•	•
		HD / wooden decor		10	•	•

MONOPROFILE in Aluminium für Laminat und Parkett

AUSGLEICHSPROFIL - einteilig, eloxiert oder Holzdekor

MONOPROFILES in aluminium for laminate and parquet

LEVEL ADAPTING PROFILES - one piece, anodized or with wooden decor



	Artikel-Nr. article-no.	Farbe colour	Beschreibung description	VE unit	Preis/lfm price/lfm 270 cm	Preis/Stück price/piece 90 cm	
	13070	silber / silver sand / sand gold / gold bronze / bronze	Ausgleichsprofil ungebohrt, Soll-Knickstelle für 7 mm Laminat level adapting profile undrilled with level accommodating groove for about 7 mm laminate	10 10 10 10	• • • •	• • • •	
			S SD G B				
		13080	silber / silver sand / sand gold / gold bronze / bronze HD / wooden decor	Ausgleichsprofil ungebohrt, Soll-Knickstelle für ca. 7-8 mm Laminat level adapting profile undrilled with level accommodating groove for about 7-8 mm laminate	10 10 10 10 10	• • • • •	• • • • •
				S SD G B			
			10 11 12 13 14 16 17 18				
		13110	silber / silver sand / sand gold / gold bronze / bronze	Ausgleichsprofil ungebohrt, Soll-Knickstelle für ca. 9-10 mm Laminat level adapting profile undrilled with level accommodating groove for about 9-10 mm laminate	10 10 10 10	• • • •	• • • •
			S SD G B				
		13150	silber / silver sand / sand gold / gold bronze / bronze HD / wooden decor	Ausgleichsprofil ungebohrt, Soll-Knickstelle für ca. 14-15 mm Parkett level adapting profile undrilled with level accommodating groove for about 14-15 mm parquet	10 10 10 10 10	• • • • •	• • • • •
				S SD G B			
			10 11 12 13 14 16 17 18				
		306	silber / silver sand / sand gold / gold bronze / bronze	VARIO - Profil / VARIO - Profile ungebohrt, schwenkbar von 3-10 mm undrilled, swivelling from 3-10 mm	10 10 10 10	• • • •	• • • •
			S SD G B				
		307	silber / silver sand / sand gold / gold bronze / bronze HD	VARIO - Profil / VARIO - Profile ungebohrt, schwenkbar von 5-16 mm undrilled, swivelling from 5-16 mm Holzdekor auf Anfrage / wooden decor on request	10 10 10 10	• • • •	• • • •
				S SD G B			

MONOPROFILE in Aluminium für Laminat und Parkett

TREPPENKANTEN - einteilig, eloxiert

MONOPROFILES in aluminium for laminate and parquet

STAIR NOSINGS - one piece, anodized



	Artikel-Nr. article-no.	Farbe colour	Beschreibung description	VE unit	Preis/lfm price/lfm 270 cm
	15070	silber / silver	für Laminat von ca. 7 mm versenkt gebohrt for laminate from ca. 7 mm countersunk drilled	10	•
		sand / sand		10	•
		gold / gold		10	•
		bronze / bronze		10	•
		EO / EO	Edelstahloptik / stainless steel optic		10
	15080	silber / silver	für Laminat von ca. 8 mm versenkt gebohrt for laminate from ca. 8 mm countersunk drilled	10	•
		sand / sand		10	•
		gold / gold		10	•
		bronze / bronze		10	•
		EO / EO	Edelstahloptik / stainless steel optic		10
	15110	silber / silver	für Parkett von ca. 10-11 mm versenkt gebohrt for parquet from ca. 10-11 mm countersunk drilled	10	•
		sand / sand		10	•
		gold / gold		10	•
		bronze / bronze		10	•
		EO / EO	Edelstahloptik / stainless steel optic		10
	15150	silber / silver	für Parkett von ca. 14-15 mm versenkt gebohrt for parquet from ca. 14-15 mm countersunk drilled	10	•
		sand / sand		10	•
		gold / gold		10	•
		bronze / bronze		10	•
		EO / EO	Edelstahloptik / stainless steel optic		10

MONOPROFILE in Aluminium für Laminat und Parkett

BIEGEPROFILE - einteilig, eloxiert

MONOPROFILES in aluminium for laminate and parquet

BENDING PROFILES - one piece, anodized



Biegeradius max. 50 cm - auf Etappen biegen!
Bending radius max. 50 cm - bending in stages!

	Artikel-Nr. article-no.	Farbe colour	Beschreibung description	VE unit	Preis/Stange price/unit 270 cm
	ST070	silber / silver gold / gold	Innenhöhe: 7 mm inner-height: 7 mm	10	•
				10	•
	ST090	silber / silver gold / gold	Innenhöhe: 9 mm inner-height: 9 mm	10	•
				10	•
	ST110	silber / silver gold / gold	Innenhöhe: 11 mm inner-height: 11 mm	10	•
				10	•
	ST150	silber / silver gold / gold	Innenhöhe: 15 mm inner-height: 15 mm	10	•
				10	•

BIEGEPROFILE in Aluminium und Edelstahl für keramische Fliesen, Stein, Laminat und Parkett

BENDING PROFILES in aluminium and stainless steel for ceramic tiles, stone, laminate and parquet

Biegeradius max. 50 cm
bending radius max. 50 cm

	Artikel-Nr. article-no.	Farbe colour	Beschreibung description	VE unit	Preis/lfm price/lfm 270 cm	Preis/lfm price/lfm 300 cm
	3119 3	roh / raw	Innenhöhe: 3 mm inner-height: 3 mm	10		•
		silber / silver	 S = Alu silber / alu silver R = Alu roh / alu raw	10		•
	3119 4,5	roh / raw	Innenhöhe: 4,5 mm inner-height: 4,5 mm	10		•
		silber / silver	 S = Alu silber / alu silver R = Alu roh / alu raw	10		•
	3119 6	roh / raw	Innenhöhe: 6 mm inner-height: 6 mm	10		•
		silber / silver	 S = Alu silber / alu silver R = Alu roh / alu raw	10		•
	3119 6	Edelstahl/ stainless steel	 E = Edelstahl / stainless steel	10	•	
	3119 8	roh / raw	Innenhöhe: 8 mm inner-height: 8 mm	10		•
		silber / silver	 S = Alu silber / alu silver R = Alu roh / alu raw	10		•
	3119 8	Edelstahl/ stainless steel	 E = Edelstahl / stainless steel	10	•	
	3119 10	silber / silver	Innenhöhe: 10 mm inner-height: 10 mm	10		•
		gold / gold	 G = Alu gold / alu gold S = Alu silber / alu silver	10		•
	3119 10	Edelstahl/ stainless steel	 E = Edelstahl / stainless steel	10	•	
	3119 12	silber / silver	Innenhöhe: 12,5 mm inner-height: 12,5 mm	10		•
		gold / gold	 G = Alu gold / alu gold S = Alu silber / alu silver	10		•
	3119 12	Edelstahl/ stainless steel	 E = Edelstahl / stainless steel	10	•	
	3119 15	roh / raw	Innenhöhe: 15 mm inner-height: 15 mm	10		•
		silber / silver	 S = Alu silber / alu silver R = Alu roh / alu raw	10		•
	3119 15	Edelstahl/ stainless steel	 E = Edelstahl / stainless steel	10	•	

T-PROFILE in Aluminium und Edelstahl zum Biegen

T-PROFILE in aluminium and stainless steel to allow bending

Biegergerät / bending machine

Biegeradius
bending radius

13514 A = max. 45 cm

13514 = max. 35 cm

13520 = max. 45 cm

13526 = max. 55 cm

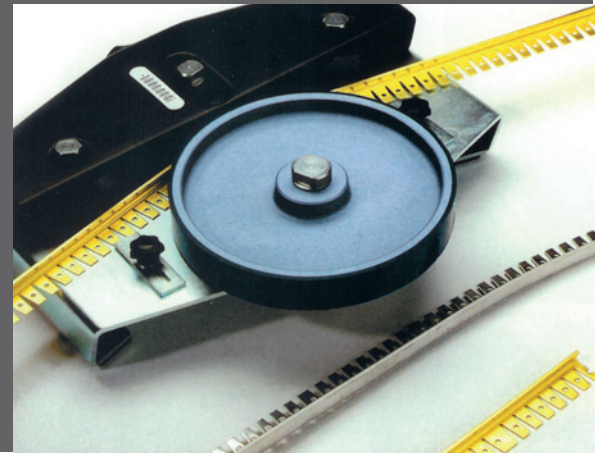

NEU / NEW

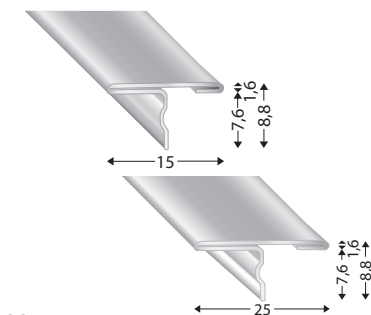
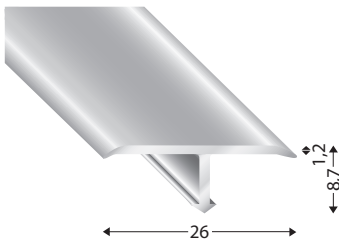
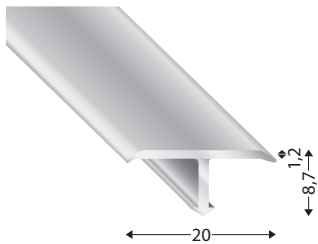
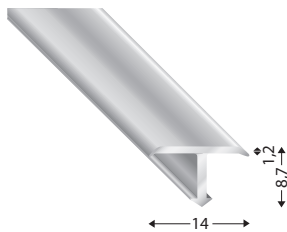
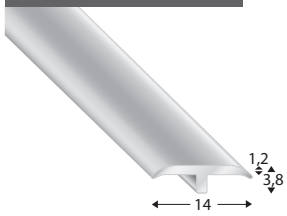

Artikel-Nr. article-no.	Farbe colour	Beschreibung description	VE unit	Preis/lfm price/lfm 270 cm
13514 A	silber / silver	biegefähig / bendable 14 x 2,2 mm EO	10	3,40
	sand / sand		10	3,64
	gold / gold		10	3,64
	bronze / bronze		10	3,48
	EO		10	3,48
13514	silber / silver	biegefähig / bendable 14 x 7 mm EO	10	4,92
	sand / sand		10	5,70
	gold / gold		10	5,70
	bronze / bronze		10	6,04
	EO		10	6,12
13520	silber / silver	biegefähig / bendable 20 x 7 mm EO	10	5,20
	sand / sand		10	6,00
	gold / gold		10	6,00
	bronze / bronze		10	6,58
	EO		10	6,12
13526	silber / silver	biegefähig / bendable 26 x 7 mm EO	10	6,12
	sand / sand		10	6,90
	gold / gold		10	6,90
	bronze / bronze		10	7,24
	EO		10	7,24
13515	Edelstahl / stainless steel	15 x 6 mm, Edelstahl / stainless steel E = Edelstahl / stainless steel	10	15,92
13525	Edelstahl / stainless steel	25 x 6 mm, Edelstahl / stainless steel E = Edelstahl / stainless steel	10	20,86

ZUBEHÖRKATALOG - zusätzliches Sortiment von KÜGELE

ACCESSORIES - other offerings from KÜGELE

STARK auch im Zubehör ...

unser Sortiment erstreckt sich nicht nur über ein umfassendes Angebot an unterschiedlichsten Bodenprofilen, sondern auch im Zubehör können wir Ihnen in den verschiedensten Einsatzbereichen eine große Auswahl an Produkten anbieten.

Sie wollen Zierprofile für Wand- oder Deckenbereich (Bovelacci oder NMC), sie benötigen schöne Holzsockelleisten als Abschluss für die Parkettverlegung?

Dem Trend entsprechend haben wir die passende Auswahl, unter Berücksichtigung der besten Qualität, wie z.B. Leisten von BOLTA oder Produkte für die Bodenverlegung von switchTec®.

Wir ermöglichen Ihnen einen umfassenden Überblick über unsere Zubehörprodukte, wozu Sie gerne jederzeit unseren Katalog anfordern können, oder uns für einen Vertreterbesuch kontaktieren. Hier können wir Sie von der Qualität anhand von Musterproben überzeugen und Ihnen gerne präsentieren!

STRONG also in accessories ...

in addition to our comprehensive range of ground profiles, we also supply a wide variety of accessories to satisfy different requirements.

You would like a decorative profile for a wall or ceiling (Bovelacci or NMC), you need an attractive wood skirting to augment a parquet floor ?

Within our product range, we have the right selection to meet the current trend, always with the best quality e.g. skirtings by BOLTA or floor laying products by switchTec®.

We offer you a comprehensive overview of our accessory range, for which you may request our catalogue at any time. If you would like one of our representatives to visit you, please call us.

Then, we can show you some installed profiles and so convince you of the suitability and quality of our products!



- **Bodenschutzmatten / floor protecting mats**
- **BOLTA Kunststoffprofile / BOLTA synthetic profiles**
- **Sockelleisten aus Holz und MDF / skirtings in wood and MDF**
- **BOVELACCI / BOVELACCI wallprofiles**
- **FIX - O - MOLL**
- **ISOL Heizkörperfolie / ISOL radiator insulation foil**
- **Heizrohrrosetten / roses for heating tubes**
- **Heizrohr Sockelleisten / skirtings hiding heating tubes**
- **Klebebänder / adhesive tapes**
- **switchTec® Klebeprodukte / switchTec® adhesive products**
- **Messing Haken- u Seilbeschläge / brass hooks and rope fittings**
- **Messing und Aluminium Vorhangstangen / brass and aluminium curtain rails**
- **Treppenseile und -steher / stair ropes and standers**
- **Teppich Gleitschutz / anti sliding carpet underlays**
- **TERRASOL Fliesen / TERRASOL tiles**
- **NMC Profile / NMC profiles**

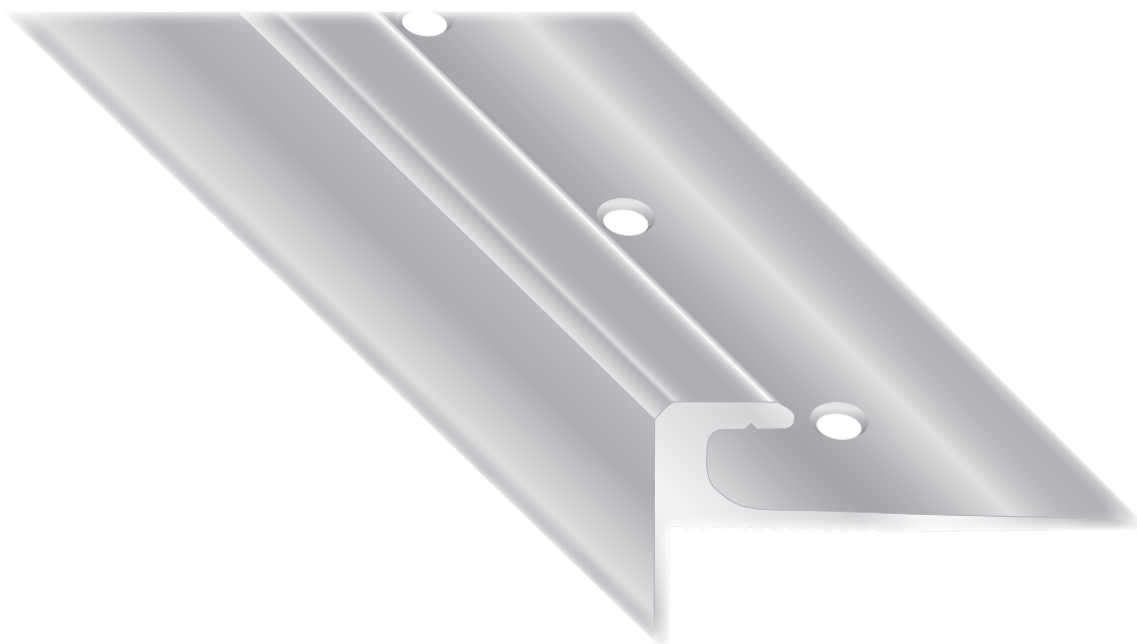

WINKEL-, ABSCHLUSS- und ÜBRGANGSPROFILE

STANDARD WINKEL-, ABSCHLUSS- und ÜBERGANGSPROFILE

in Aluminium

STANDARD ANGLE EDGES-, END- and JOINING PROFILES

in aluminium



STANDARD-WINKELPROFILE in Aluminium

gebohrt, ungebohrt oder selbstklebend

STANDARD - ANGLE PROFILES in aluminium

drilled, undrilled or self-adhesive

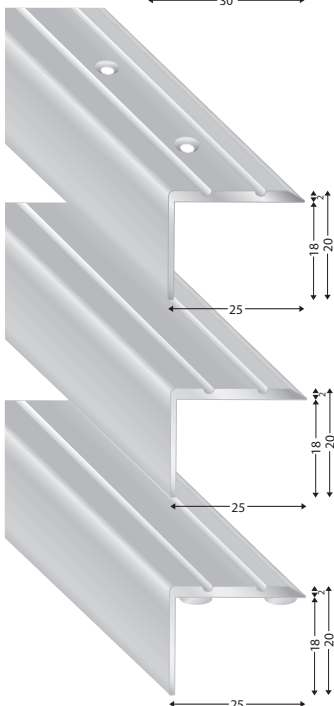
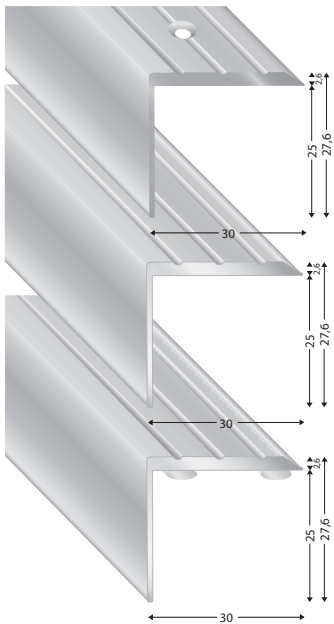
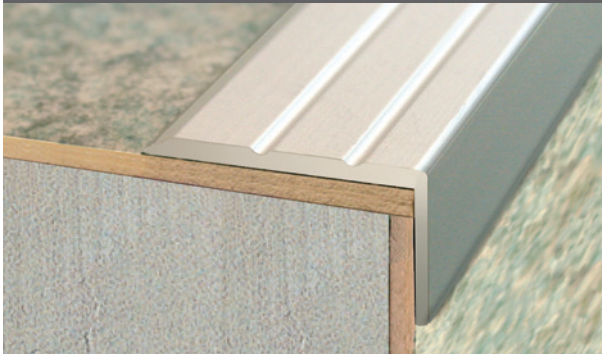

Artikel-Nr. article-no.	Farbe colour	Beschreibung description	VE unit	Preis/lfm price/lfm 270 cm	Preis/Stück price/piece 100 cm	Preis/Stück price/piece 90 cm	
MK 1105 A	silber / silver	versenkt gebohrt - schwere Ausführung countersunk drilled - heavy quality	10	•	•		
	sand / sand		10	•	•		
	gold / gold		10	•	•		
	bronze / bronze		10	•	•		
MK 1105 A U	silber / silver	ungebohrt - schwere Ausführung undrilled - heavy quality	10	•			
	sand / sand		10	•			
	gold / gold		10	•			
	bronze / bronze		10	•			
MK 1105 A SKL	silber / silver	selbstklebend - schwere Ausführung self-adhesive - heavy quality	10	•	•		
	sand / sand		10	•	•		
	gold / gold		10	•	•		
	bronze / bronze		10	•	•		
MK 105 A	silber / silver	versenkt gebohrt / countersunk drilled	10	•	•		
	sand / sand		10	•	•		
	gold / gold		10	•	•		
	bronze / bronze		10	•	•		
	EO	Edelstahloptik / stainless steel optic		10	•	•	
MK 105 A U	silber / silver	ungebohrt / undrilled	10	•			
	sand / sand		10	•			
	gold / gold		10	•			
	bronze / bronze		10	•			
	EO	Edelstahloptik / stainless steel optic		10	•		
MK 105 A SKL	silber / silver	selbstklebend / self-adhesive	10	•	•		
	sand / sand		10	•	•		
	gold / gold		10	•	•		
	bronze / bronze		10	•	•		
	EO	Edelstahloptik / stainless steel optic		10	•	•	
	Holzdekor / wooden decor			10	•	•	

STANDARD-WINKELPROFILE in Aluminium

gebohrt, ungebohrt oder selbstklebend

STANDARD - ANGLE PROFILES in aluminium

drilled, undrilled or self-adhesive

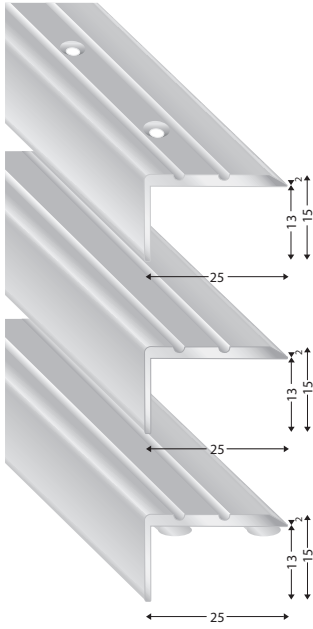
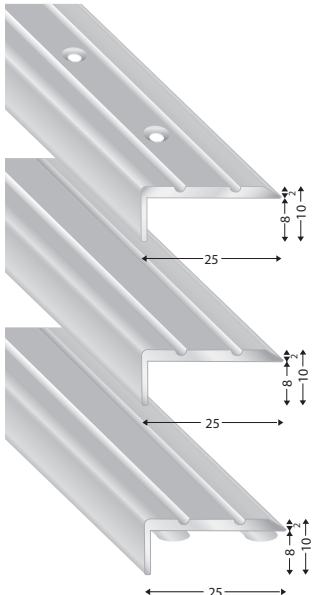

Artikel-Nr. article-no.	Farbe colour	Beschreibung description	VE unit	Preis/lfm price/lfm 270 cm	Preis/Stück price/piece 100 cm	Preis/Stück price/piece 90 cm
MK 105 B	silber / silver	versenkt gebohrt / countersunk drilled	10	•	•	
	sand / sand		10	•	•	
	gold / gold		10	•	•	
	bronze / bronze		10	•	•	
	EO	Edelstahloptik / stainless steel optic	10	•	•	
MK 105 B U	silber / silver	ungebohrt / undrilled	10	•		
	sand / sand		10	•		
	gold / gold		10	•		
	bronze / bronze		10	•		
	EO	Edelstahloptik / stainless steel optic	10	•		
MK 105 B SKL	silber / silver	selbstklebend / self-adhesive	10	•	•	
	sand / sand		10	•	•	
	gold / gold		10	•	•	
	bronze / bronze		10	•	•	
	EO	Edelstahloptik / stainless steel optic	10	•	•	
	Holzdekor / wooden decor		10	•		•
MK 105 C	silber / silver	versenkt gebohrt / countersunk drilled	10	•	•	
	sand / sand		10	•	•	
	gold / gold		10	•	•	
	bronze / bronze		10	•	•	
	EO	Edelstahloptik / stainless steel optic	10	•	•	
MK 105 C U	silber / silver	ungebohrt / undrilled	10	•		
	sand / sand		10	•		
	gold / gold		10	•		
	bronze / bronze		10	•		
	EO	Edelstahloptik / stainless steel optic	10	•		
MK 105 C SKL	silber / silver	selbstklebend / self-adhesive	10	•	•	
	sand / sand		10	•	•	
	gold / gold		10	•	•	
	bronze / bronze		10	•	•	
	EO	Edelstahloptik / stainless steel optic	10	•	•	

STANDARD-NASENSCHIENEN in Aluminium

gebohrt, ungebohrt oder selbstklebend

STANDARD - COVER STRIPS in aluminium

drilled, undrilled or self-adhesive



	Artikel-Nr. article-no.	Farbe colour	Beschreibung description	VE unit	Preis/lfm price/lfm 270 cm	Preis/Stück price/piece 100 cm
	MK 201	silber / silver sand / sand gold / gold bronze / bronze EO	versenkt gebohrt Edelstahloptik / stainless steel optic	10 10 10 10 10	• • • • •	• • • • •
	MK 201 U	silber / silver sand / sand gold / gold bronze / bronze EO	ungebohrt / undrilled Edelstahloptik / stainless steel optic	10 10 10 10 10	• • • • •	
	MK 201 SKL	silber / silver sand / sand gold / gold bronze / bronze EO	selbstklebend / self-adhesive Edelstahloptik / stainless steel optic	10 10 10 10 10	• • • • •	• • • • •
	MK 202	silber / silver sand / sand gold / gold bronze / bronze EO	gebohrt / drilled Edelstahloptik / stainless steel optic	10 10 10 10 10	• • • • •	• • • • •
	MK 202 U	silber / silver sand / sand gold / gold bronze / bronze EO	ungebohrt / undrilled Edelstahloptik / stainless steel optic	10 10 10 10 10	• • • • •	
MK 202 SKL	silber / silver sand / sand gold / gold bronze / bronze EO	selbstklebend / self-adhesive Edelstahloptik / stainless steel optic	10 10 10 10 10	• • • • •	• • • • •	
	MK 202	silber / silver sand / sand gold / gold bronze / bronze EO	gebohrt / drilled Edelstahloptik / stainless steel optic	10 10 10 10 10	• • • • •	• • • • •
	MK 202 U	silber / silver sand / sand gold / gold bronze / bronze	ungebohrt / undrilled Edelstahloptik / stainless steel optic	10 10 10 10	• • • •	
	MK 202 SKL	silber / silver sand / sand gold / gold bronze / bronze	selbstklebend / self-adhesive Edelstahloptik / stainless steel optic	10 10 10 10	• • • •	• • • •

STANDARD-NASENSCHIENEN in Aluminium

gebohrt, ungebohrt oder selbstklebend

STANDARD - COVER STRIPS in aluminium

drilled, undrilled or self-adhesive

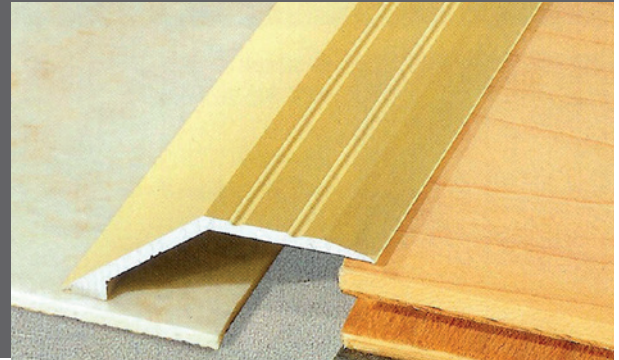

	Artikel-Nr. article-no.	Farbe colour	Beschreibung description	VE unit	Preis/lfm price/lfm	Preis/Stück price/piece	Preis/Stück price/piece
					270 cm	100 cm	90 cm
	MK 201 10	silber / silver sand / sand gold / gold bronze / bronze EO	versenkt gebohrt / countersunk drilled	10	•	•	
				10	•	•	
			Edelstahloptik / stainless steel optic	10	•	•	
				10	•	•	
				10	•	•	
	MK 201 10 U	silber / silver sand / sand gold / gold bronze / bronze EO	ungebohrt / undrilled	10	•		
				10	•		
			Edelstahloptik / stainless steel optic	10	•		
				10	•		
				10	•		
	MK 201 10 SKL	silber / silver sand / sand gold / gold bronze / bronze EO Holzdekor / wooden decor	selbstklebend / self-adhesive	10	•	•	
				10	•	•	
			Edelstahloptik / stainless steel optic	10	•	•	
				10	•	•	
				10	•	•	•
	MK 201 15	silber / silver sand / sand gold / gold bronze / bronze EO	versenkt gebohrt / countersunk drilled	10	•	•	
				10	•	•	
			Edelstahloptik / stainless steel optic	10	•	•	
				10	•	•	
				10	•	•	
	MK 201 15 U	silber / silver sand / sand gold / gold bronze / bronze EO	ungebohrt / undrilled	10	•		
				10	•		
			Edelstahloptik / stainless steel optic	10	•		
				10	•		
				10	•		
	MK 201 15 SKL	silber / silver sand / sand gold / gold bronze / bronze EO Holzdekor / wooden decor	selbstklebend / self-adhesive	10	•	•	
				10	•	•	
			Edelstahloptik / stainless steel optic	10	•	•	
				10	•	•	
				10	•	•	•
	201 22 S	silber / silver	versenkt gebohrt / countersunk drilled	10	•		
	201 22 SKL	silber / silver Holzdekor / wooden decor	selbstklebend / self-adhesive	10	•		
			Lieferzeit 4-5 Wochen Delivery time 4-5 weeks	10	•		

STANDARD-ABSCHLUSSPROFILE und TREPPENKANTEN in Aluminium

für Teppich, Kunststoff-, Kork- und Linolbeläge

STANDARD-END PROFILES and STAIR-NOSINGS in aluminium

for carpet, synthetic, cork and linoleum floorings



	Artikel-Nr. article-no.	Farbe colour	Beschreibung description	VE unit	Preis/lfm price/lfm 270 cm	Preis/Stange price/unit 270 cm
	108 A	silber / silver	gebohrt / drilled Nase 1 mm / nose 1 mm S G B Biegsam nach Einschnitten! Bending capability! Not prepunched!	10	•	
		gold / gold				
		bronze / bronze		10	•	
	ST 108 A	silber / silver	Bereits eingeschnitten! / Prepunched! 	S	10	•
	108 B	silber / silver	gebohrt / drilled Nase 1 mm / nose 1 mm S G B Biegsam nach Einschnitten! Bending capability! Not prepunched!	10	•	
		gold / gold				
		bronze / bronze		10	•	
	ST 108 B	silber / silver	Bereits eingeschnitten! / Prepunched! 	S	10	•
	108 C	silber / silver	gebohrt / drilled Nase 2,2 mm / nose 2,2 mm S G B Biegsam nach Einschnitten! Bending capability! Not prepunched!	10	•	
		gold / gold				
		bronze / bronze		10	•	
	ST 108 C	silber / silver	Bereits eingeschnitten! / Prepunched! 	S	10	•
	108 D	silber / silver	gebohrt / drilled Nase 2,2 mm / nose 2,2 mm S G B Biegsam nach Einschnitten! Bending capability! Not prepunched!	10	•	
		gold / gold				
		bronze / bronze		10	•	
	ST 108 D	silber / silver	Bereits eingeschnitten! / Prepunched! 	S	10	•

STANDARD-ABSCHLUSSPROFILE und TREPPENKANTEN in Aluminium

für Teppiche, Kunststoff-, Kork- und Linolbeläge

STANDARD-END PROFILES and STAIR-NOSINGS in aluminium

for carpet, synthetic, cork and linoleum floorings

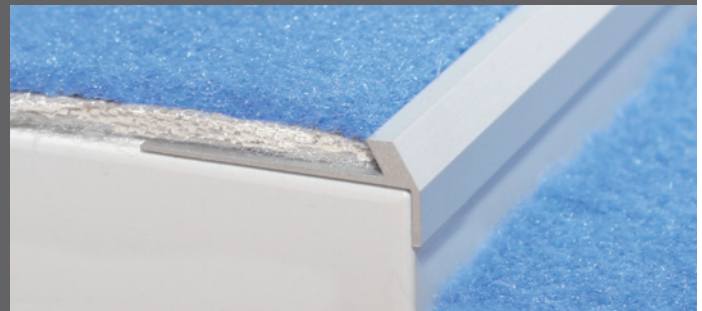

	Artikel-Nr. article-no.	Farbe colour	Beschreibung description	VE unit	Preis/lfm price/lfm 270 cm	Preis/Stange price/unit 270 cm
	108 E	silber / silver gold / gold bronze / bronze	Innenhöhe 3 mm / inner-height 3 mm gebohrt / drilled Biegsam nach Einscheiden! Bending capability! Not prepunched!	10 10 10	• • •	
	ST 108 E	silber / silver	Bereits eingeschnitten! / Prepunched! 	 10		•
NEU / NEW 	108 F	silber / silver	versenkt gebohrt / countersunk drilled 	10	•	
	108 K	silber / silver gold / gold bronze / bronze	gebohrt / drilled Biegsam nach Einscheiden! Bending capability! Not prepunched!	10 10 10	• • •	
	ST 108 K	silber / silver	Bereits eingeschnitten! / Prepunched! 	 10		•
	108 M	silber / silver sand / sand gold / gold bronze / bronze	gebohrt / drilled Biegsam nach Einscheiden! Bending capability! Not prepunched!	10 10 10 10	• • • •	
	ST 108 M	silber / silver	Bereits eingeschnitten! / Prepunched! 	 10		•
	108 P	silber / silver	Innenhöhe 4 mm / inner-height 4 mm gebohrt / drilled 	10	•	

STANDARD KLEMMPROFIL in Aluminium und DEHNFUGE in Kunststoff STANDARD EDGE TRIM in aluminium and EXPANSION JOINT in synthetic

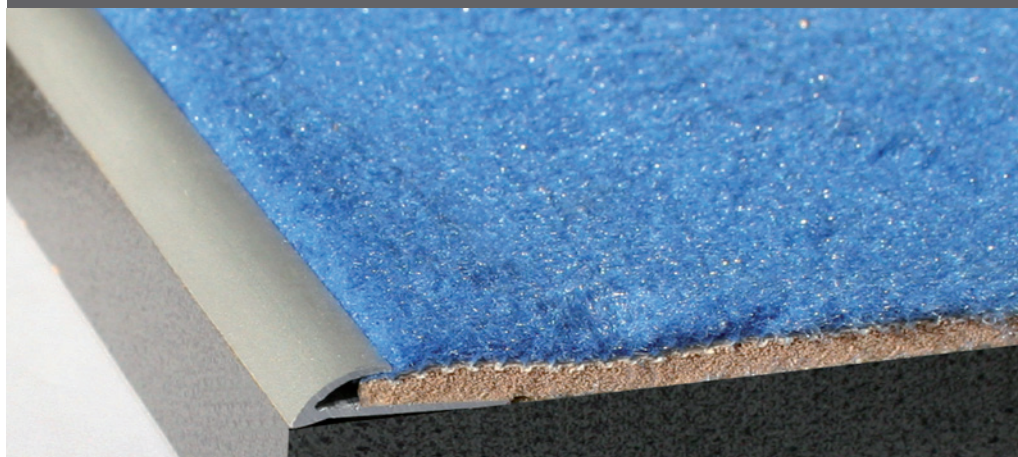

für 3-5 mm
for 3-5 mm

	Artikel-Nr. article-no.	Farbe colour	Beschreibung description	VE unit	Preis/lfm price/lfm 270 cm
	206 A	silber / silver	Klemmprofil / clip profile S SD G B	10	•
		sand / sand		10	•
		gold / gold		10	•
		bronze / bronze		10	•
	208 A	silber / silver	Klemmprofil gebohrt / clip profile drilled S SD G B	10	•
		sand / sand		10	•
		gold / gold		10	•
		bronze / bronze		10	•
		EO		10	•
	DF 603	schwarz / black	Kombination - Hart/Weich-Kunststoff Für Belagstärke 3 mm combination of soft and rigid PVC heights from 3 mm • •	10	•
		grau / grey		10	•
	DF 604	grau / grey	Kombination - Hart/Weich-Kunststoff Für Belagstärke 4,5 mm combination of soft and rigid PVC heights from 4,5 mm •	10	•

STANDARD-ABSCHLUSSPROFILE und TREPPENKANTEN in Aluminium für Teppich, Kunststoff-, Kork- und Linolbeläge

STANDARD-END PROFILES and STAIR-NOSINGS in aluminium for carpet, synthetic, cork and linoleum floorings

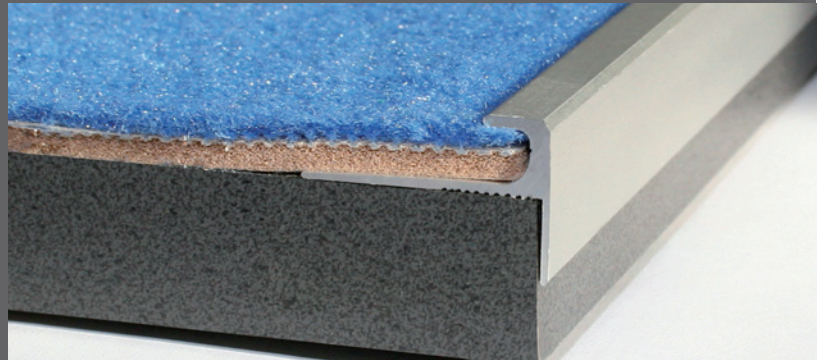

	Artikel-Nr. article-no.	Farbe colour	Beschreibung description	VE unit	Preis/lfm price/lfm 270 cm
	112	silber / silver	gebohrt, Innenhöhe 6,75 mm drilled, inner-height 6,75 mm	10	•
		sand / sand		10	•
		gold / gold		10	•
		bronze / bronze		10	•
	113	silber / silver	gebohrt, Innenhöhe 4,5 mm drilled, inner-height 4,5 mm	10	•
		sand / sand		10	•
		gold / gold		10	•
		bronze / bronze		10	•
	113 A	silber / silver	gebohrt / drilled speziell für Türschwellen, Innenhöhe 4,5 mm especially for thresholds, inner-height 4,5 mm	10	•
		sand / sand		10	•
		gold / gold		10	•
		bronze / bronze		10	•
	113 B	silber / silver	gebohrt, Innenhöhe 2,5 mm drilled, inner-height 2,5 mm	10	•
		sand / sand		10	•
		gold / gold		10	•
		bronze / bronze		10	•
	113 C	silber / silver	gebohrt, Innenhöhe 5 mm drilled, inner-height 5 mm	10	•
		sand / sand		10	•
		gold / gold		10	•
		bronze / bronze		10	•
	113 D	silber / silver	gebohrt / drilled speziell für Türschwellen, Innenhöhe 5 mm especially for thresholds, inner-height 5 mm	10	•
		sand / sand		10	•
		gold / gold		10	•
		bronze / bronze		10	•

STANDARD-ABSCHLUSSPROFILE und TREPPENKANTEN in Aluminium

für Teppich, Kunststoff-, Kork- und Linolbeläge

STANDARD-END PROFILES and STAIR-NOSINGS in aluminium

for carpet, synthetic, cork and linoleum floorings

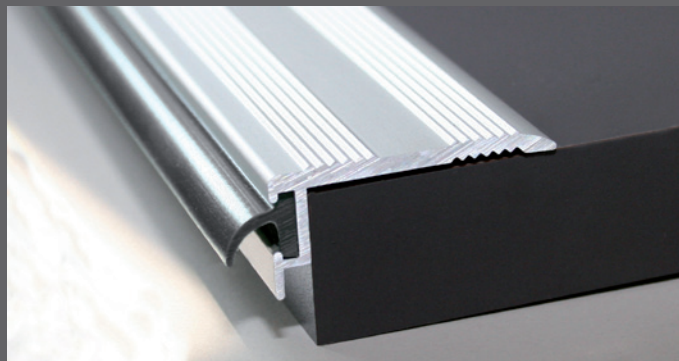

	Artikel-Nr. article-no.	Farbe colour	Beschreibung description	VE unit	Preis/lfm price/lfm 270 cm	Preis/Stange price/unit 270 cm	Preis/lfm price/lfm 300 cm
	3515 DL	silber / silver sand / sand	versenkt gebohrt / countersunkdrilled ohne Dichtlippe without sealing-lip	10			•
	3515 DL U	silber / silver sand / sand	ungebohrt / undrilled	10			•
	DL 810	GR SR	Dichtlippe in grau und schwarz sealing-lip in black and grey Rolle= 30m / rolls=30m	1 1	• /lfm • /lfm		
	114	silber / silver sand / sand gold / gold bronze / bronze	gebohrt / drilled Biegsam nach Einschneiden! Bending capability! Not prepunched!	10 10 10 10	• • • •		
	ST 114	silber / silver	Bereits eingeschnitten! / Prepunched!	10		•	
	115	silber / silver sand / sand gold / gold bronze / bronze	gebohrt / drilled Biegsam nach Einschneiden! Bending capability! Not prepunched!	10 10 10 10	• • • •		
	ST 115	silber / silver	Bereits eingeschnitten! / Prepunched!	10		•	
	115 A	silber / silver sand / sand gold / gold bronze / bronze	gebohrt / drilled Biegsam nach Einschneiden! Bending capability! Not prepunched!	10 10 10 10	• • • •		
	ST 115 A	silber / silver	Bereits eingeschnitten! / Prepunched!	10		•	
	115 B	silber / silver sand / sand gold / gold bronze / bronze	gebohrt / drilled Biegsam nach Einschneiden! Bending capability! Not prepunched!	10 10 10 10	• • • •		
	ST 115 B	silber / silver	Bereits eingeschnitten! / Prepunched!	10		•	

STANDARD-ÜBERGANGSPROFILE in Aluminium

gebohrt, ungebohrt und selbstklebend

STANDARD-JOINING PROFILES in aluminium

drilled, undrilled and self-adhesive



	Artikel-Nr. article-no.	Farbe colour	Beschreibung description	VE unit	Preis/lfm price/lfm 270 cm	Preis/Stück price/piece 100 cm
	301	silber / silver	versenkt gebohrt - countersunk drilled	10	•	•
		sand / sand		10	•	•
		gold / gold	Edelstahloptik - stainless steel optic	10	•	•
		bronze / bronze		10	•	•
		EO		10	•	•
	301 A	silber / silver	versenkt gebohrt / countersunk drilled	10	•	•
		sand / sand		10	•	•
		gold / gold		10	•	•
		bronze / bronze		10	•	•
		EO		10	•	•
	301 A U	silber / silver	ungebohrt / undrilled	10	•	•
		sand / sand		10	•	•
		gold / gold	Edelstahloptik - stainless steel optic	10	•	•
		bronze / bronze		10	•	•
		EO		10	•	•
	301 A SKL	silber / silver	selbstklebend / self-adhesive	10	•	•
		sand / sand		10	•	•
		gold / gold	Edelstahloptik - stainless steel optic	10	•	•
		bronze / bronze		10	•	•
		EO		10	•	•
	303	silber / silver	versenkt gebohrt / countersunk drilled	10	•	•
		sand / sand		10	•	•
		gold / gold		10	•	•
		bronze / bronze		10	•	•
	304	silber / silver	ungebohrt / undrilled	10	•	•
		sand / sand		10	•	•
		gold / gold		10	•	•
		bronze / bronze		10	•	•

STANDARD-ÜBERGANGSPROFILE in Aluminium

selbstklebend, gebohrt und ungebohrt

STANDARD-JOINING PROFILES in aluminium

self-adhesive, drilled and undrilled



	Artikel-Nr. article-no.	Farbe colour	Beschreibung description	VE unit	Preis/lfm price/lfm	Preis/Stück price/piece
					270 cm	100 cm
	638 GEB	silber / silver	Übergangprofil / Joining Profile gebohrt / drilled	10	•	•
		sand / sand	38 x 1,7 mm (Materialstärke / material thickness)	10	•	•
		gold / gold		10	•	•
		bronze / bronze	Edelstahloptik / stainless steel optic	10	•	•
		EO	SB 100 cm inkl. Schrauben und Dübel SB 100 cm incl. screws and dowels	10	•	•
	638 UNG	silber / silver	Übergangprofil / Joining Profile ungebohrt / undrilled	10	•	•
		sand / sand	38 x 1,7 mm (Materialstärke / material thickness)	10	•	•
		gold / gold		10	•	•
		bronze / bronze	Edelstahloptik / stainless steel optic	10	•	•
		EO		10	•	•
	638 SKL	silber / silver	Übergangprofil / Joining Profile selbstklebend / self-adhesive	10	•	•
		sand / sand	38 x 1,7 mm (Materialstärke / material thickness)	10	•	•
		gold / gold		10	•	•
		bronze / bronze	Edelstahloptik / stainless steel optic	10	•	•
		EO		10	•	•

STANDARD-ÜBERGANGSPROFILE in Aluminium

selbstklebend, gebohrt und ungebohrt

STANDARD-JOINING PROFILES in aluminium

self-adhesive, drilled and undrilled



	Artikel-Nr. article-no.	Farbe colour	Beschreibung description	VE unit	Preis/lfm price/lfm 270 cm	Preis/Stück price/piece 100 cm
	629 GEB	silber / silver	Übergangsprofil / <i>Joining Profile</i> gebohrt / drilled 29,5 x 1,5 mm 	10	•	•
		sand / sand		10	•	•
		gold / gold		10	•	•
		bronze / bronze		10	•	•
		EO		10	•	•
	629 UNG	silber / silver	Übergangsprofil / <i>Joining Profile</i> ungebohrt / undrilled 29,5 x 1,5 mm 	10	•	
		sand / sand		10	•	
		gold / gold		10	•	
		bronze / bronze		10	•	
		EO		10	•	
	629 SKL	silber / silver	Übergangsprofil / <i>Joining Profile</i> selbstklebend / self-adhesive 29,5 x 1,5 mm 	10	•	•
		sand / sand		10	•	•
		gold / gold		10	•	•
		bronze / bronze		10	•	•
		EO		10	•	•

STANDARD-ÜBERGANGSPROFILE und HOHLFLACHPROFILE in Aluminium und Edelstahl - selbstklebend

STANDARD-JOINING PROFILES and COVER STRIPS in aluminium and stainless steel - self-adhesive



	Artikel-Nr. article-no.	Farbe colour	Beschreibung description	VE unit	Preis/lfm price/lfm 270 cm	Preis/Stück price/piece 100 cm	Preis/Stange price/unit 270 cm																	
	503 30 SKL	silber / silver	selbstklebend / self-adhesive 30 mm	10	•	•																		
		sand / sand							10	•	•													
		gold / gold											Edelstahloptik / stainless steel optic	10	•	•								
		bronze / bronze																	10	•	•			
		EO																					10	•
		Holzdekor / wooden decor																10						
	503 40 SKL	silber / silver	selbstklebend / self-adhesive 40 mm	10	•	•																		
		sand / sand							10	•	•													
		gold / gold											Edelstahloptik / stainless steel optic	10	•	•								
		bronze / bronze																		10	•	•	(90 cm)	
		EO																10						•
		Holzdekor / wooden decor																	10					
	503 50 SKL	silber / silver	selbstklebend / self-adhesive 50 mm	10	•	•																		
		sand / sand							10	•	•													
		gold / gold											Edelstahloptik / stainless steel optic	10	•	•								
		bronze / bronze																		10	•	•		
		10	•	•																				
							10	•	•															

STANDARD-ÜBERGANGSPROFILE in Aluminium und Edelstahl

gebohrt und ungebohrt

STANDARD-JOINING PROFILES in aluminium and stainless steel

drilled and undrilled







	Artikel-Nr. article-no.	Farbe colour	Beschreibung description	VE unit	Preis/lfm price/lfm 270 cm	Preis/Stück price/piece 100 cm	Preis/Stange price/unit 270 cm
	803 30 U	silber / silver	ungebohrt / undrilled 30 mm	10	•	•	
		sand / sand		10	•	•	
		gold / gold		10	•	•	
		bronze / bronze		10	•	•	
		EO	Edelstahloptik / stainless steel optic	10	•	•	
	903 30 U	Edelstahl / stainless steel	ungebohrt / undrilled	10			•
	803 30 GEB	silber / silver	versenkt gebohrt / countersunk drilled 30 mm	10	•	•	
		sand / sand		10	•	•	
		gold / gold		10	•	•	
		bronze / bronze		10	•	•	
		EO	Edelstahloptik / stainless steel optic	10	•	•	
	903 30 GEB	Edelstahl / stainless steel	versenkt gebohrt / countersunk drilled	10			•
	9031 30 E	Edelstahl / stainless steel	seitlich versenkt gebohrt / laterally countersunk drilled 30 mm	10			•
	803 40 U	silber / silver	ungebohrt / undrilled 40 mm	10	•	•	
		sand / sand		10	•	•	
		gold / gold		10	•	•	
		bronze / bronze		10	•	•	
		EO	Edelstahloptik / stainless steel optic	10	•	•	
	903 40 U	Edelstahl / stainless steel	ungebohrt / undrilled	10			•

STANDARD-ÜBERGANGSPROFILE in Aluminium und Edelstahl

gebohrt und ungebohrt

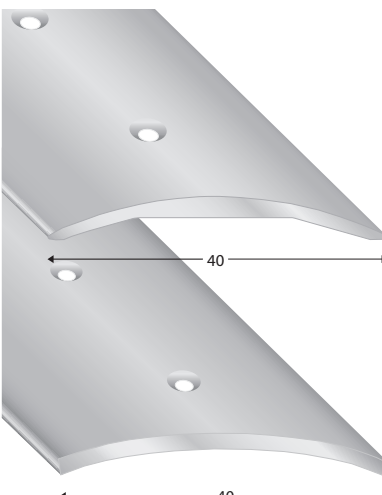
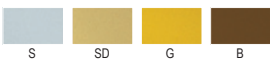
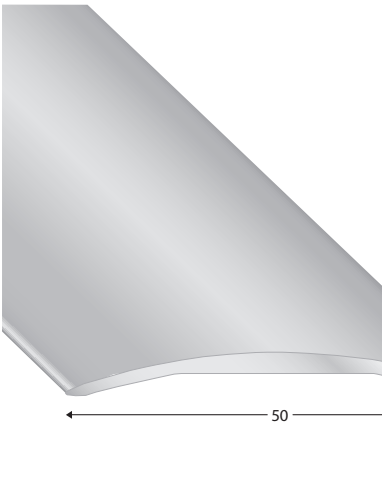
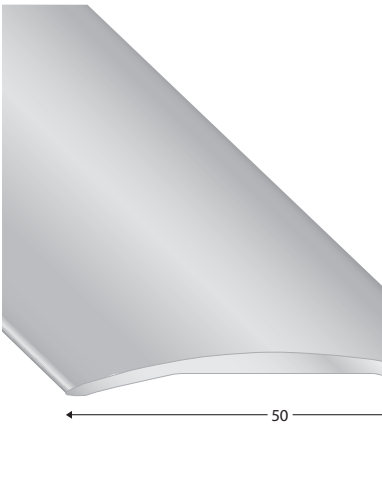
STANDARD-JOINING PROFILES in aluminium and stainless steel

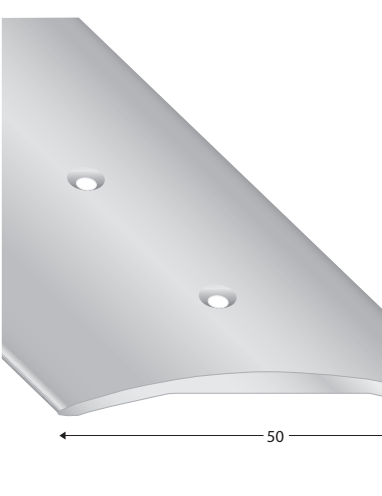
drilled and undrilled

	Artikel-Nr. article-no.	Farbe colour	Beschreibung description	VE unit	Preis/lfm price/lfm 270 cm	Preis/Stück price/piece 100 cm	Preis/Stange price/unit 270 cm	
 <p>Technical drawing of a 40 mm wide countersunk drilled profile. Dimensions: width 40 mm, depth 2.5 mm, countersink depth 4.5 mm.</p>	803 40 GEB	silber / silver	40 mm - versenkt gebohrt / countersunk drilled	10	•	•		
		sand / sand						
		gold / gold						
		bronze / bronze						
		EO						Edelstahloptik / stainless steel optic
 <p>Technical drawing of a 40 mm wide undrilled profile. Dimensions: width 40 mm, depth 1.5 mm.</p>	903 40 GEB	Edelstahl / stainless steel	versenkt gebohrt / countersunk drilled	10			•	
 <p>Technical drawing of a 50 mm wide undrilled profile. Dimensions: width 50 mm, depth 2.5 mm, countersink depth 4.5 mm.</p>	803 50 U	silber / silver	50 mm - ungebohrt / undrilled	10	•	•		
		sand / sand						
		gold / gold						
		bronze / bronze						
 <p>Technical drawing of a 50 mm wide countersunk drilled profile. Dimensions: width 50 mm, depth 2.5 mm, countersink depth 4.5 mm.</p>	803 50 GEB	silber / silver	50 mm - versenkt gebohrt / countersunk drilled	10	•	•		
		sand / sand						
		gold / gold						
		bronze / bronze						

STANDARD-ÜBERGANGS- und TERRASSENPROFIL in Aluminium und Edelstahl - ungebohrt und selbstklebend

STANDARD-JOINING and TERRACEPROFILE in aluminium and stainless steel - undrilled and self-adhesive

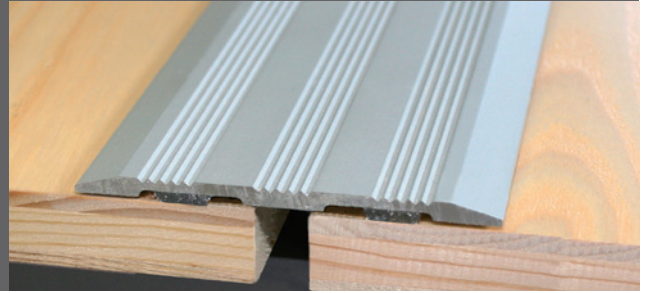

	Artikel-Nr. article-no.	Farbe colour	Beschreibung description	VE unit	Preis/lfm price/lfm 270 cm	Preis/lfm price/lfm 300 cm
	136 CP 8	silber / silver	80 mm - ungebohrt, 80 mm / undrilled	10	•	
	136 CP 8 SKL	silber / silver	80 mm - selbstklebend, 80 mm / self-adhesive	10	•	
	136 CP 8 E	Edelstahl / stainless steel	80 mm - selbstklebend, glatt 80 mm - self-adhesive, not grooved 1 mm Materialstärke (material thickness)	10		•
			E = Edelstahl / stainless steel			
	66448	silber / silver	TERRASSENPROFIL für Fenster und Türen - Kondenswasserprof TERRACEPROFILE for windows and doors - water prof condensed	10		•
	1519	silber / silver sand / sand gold / gold bronze / bronze weiß / white EO	TERRASSENPROFIL selbstklebend TERRACEPROFILE self-adhesive	10	•	
			S		10	•
			SD		10	•
			G		10	•
			B		10	•
			weiß/white		10	•
		Edelstahloptik / stainless steel optic		10	•	



TREPPEN- und MAUERKANTEN

TREPPEN- und MAUERKANTEN *STAIR NOSINGS and WALL CORNERS*

ESTRICH-WINKEL *ANGLES for SCREED FLOORS*



TREPPENKANTEN in Aluminium für alle Beläge

STAIR-NOSINGS in aluminium for all types of flooring

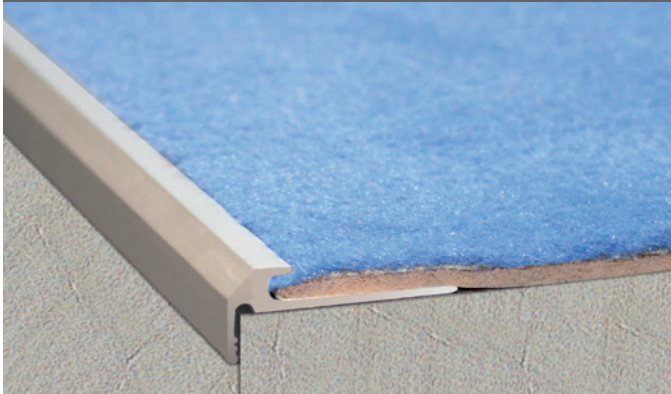

Noch nicht eingeschnitten!
Zuschlag für Einschnitte zum Biegen auf Anfrage!

Not prepunched!
Extra charge for punching to enable bending on request!

	Artikel-Nr. article-no.	Farbe colour	Beschreibung description	VE unit	Preis/lfm price/lfm 270 cm	Preis/Stange price/unit 270 cm
	111	silber / silver	gebohrt, Schlupfhöhe 6,5 mm drilled, inner height 6,5 mm 	5	•	
		sand / sand		5	•	
		gold / gold		5	•	
		bronze / bronze		5	•	
	111 A	silber / silver	gebohrt, Schlupfhöhe 4,2 mm drilled, inner height 4,2 mm 	5	•	
		gold / gold		5	•	
		bronze / bronze		5	•	
	ST 111 A	silber / silver	Bereits eingeschnitten! / <i>Prepunched!</i> 		5	•
<div style="background-color: black; color: white; padding: 2px; font-weight: bold;">NEU / NEW</div>	111 C	silber / silver	5 mm Schlupfhöhe / 5 mm inner-height 	5	•	
		gold / gold		5	•	
		bronze / bronze		5	•	
	111 B	silber / silver	gebohrt, Schlupfhöhe 4,2 mm drilled, inner height 4,2 mm 	5	•	
		gold / gold		5	•	

TREPPENKANTEN in Aluminium und Edelstahl für alle Beläge

STAIR-NOSINGS in aluminium and stainless steel for all types of flooring

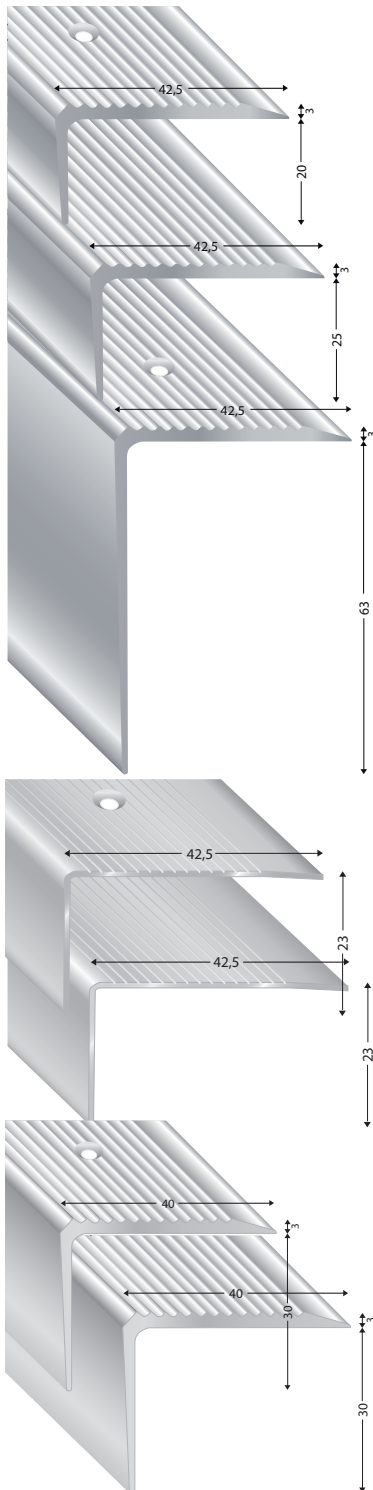
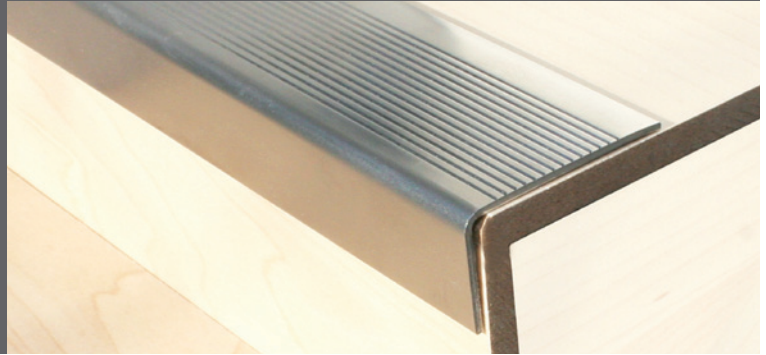

Artikel-Nr. article-no.	Farbe colour	Beschreibung description	VE unit	Preis/lfm price/lfm 270 cm	Preis/Stange price/unit 300 cm
3101	silber / silver	versenkt gebohrt / countersunk drilled	5	•	
	sand / sand		5	•	
	gold / gold		5	•	
	bronze / bronze		5	•	
	EO	Edelstahloptik / stainless steel optic	5	•	
3101 U	silber / silver	ungebohrt / undrilled	5	•	
	sand / sand		5	•	
	gold / gold		5	•	
	bronze / bronze		5	•	
	EO	Edelstahloptik / stainless steel optic	5	•	
3102	silber / silver	versenkt gebohrt / countersunk drilled fein gerillt / grooved	5	•	
3102 U	silber / silver	ungebohrt / undrilled	5	•	
3103	silber / silver	versenkt gebohrt / countersunk drilled	5	•	
3103 U	silber / silver	ungebohrt / undrilled	5	•	
3104	Edelstahl / stainless steel	EDELSTAHL, versenkt gebohrt STAINLESS STEEL, countersunk drilled	5		•
		Materialstärke / material thickness 1,5 mm			
3104 U	Edelstahl / stainless steel	EDELSTAHL, ungebohrt STAINLESS STEEL, undrilled	5		•
		Materialstärke / material thickness 1,5 mm			
3105	silber / silver	stark gerillt, versenkt gebohrt heavily-grooved, countersunk drilled	5	•	
	sand / sand		5	•	
	gold / gold		5	•	
	bronze / bronze		5	•	
	EO	Edelstahloptik / stainless steel optic	5	•	
3105 U	silber / silver	ungebohrt / undrilled	5	•	
	sand / sand		5	•	
	gold / gold		5	•	
	bronze / bronze		5	•	
	EO	Edelstahloptik / stainless steel optic	5	•	

TREPPENKANTEN in Aluminium für alle Beläge

STAIR-NOSINGS in aluminium for all types of floorings

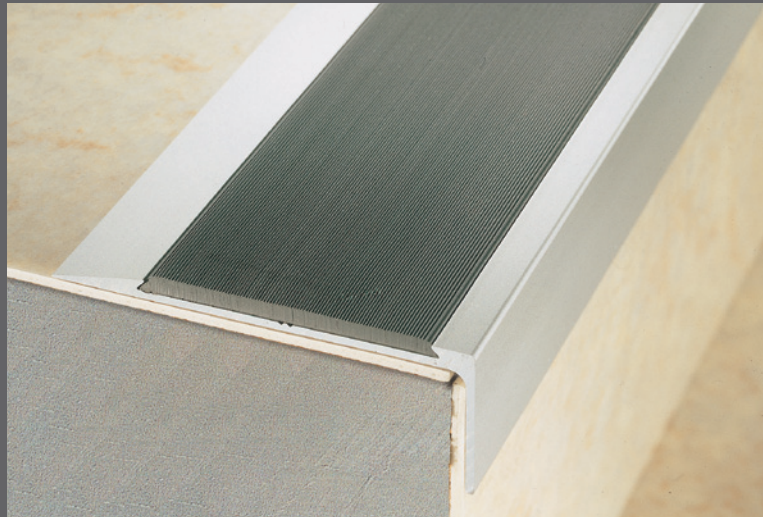

	Artikel-Nr. article-no.	Farbe colour	Beschreibung description	VE unit	Preis/lfm price/lfm 270 cm
	3106	silber / silver	versenkt gebohrt - OHNE EINLAGESTREIFEN countersunk drilled - WITHOUT INSERT STRIP 	5	•
		sand / sand		5	•
		gold / gold		5	•
		bronze / bronze		5	•
	3107	silber / silver	versenkt gebohrt - OHNE EINLAGESTREIFEN countersunk drilled - WITHOUT INSERT STRIP 	5	•
		sand / sand		5	•
		gold / gold		5	•
		bronze / bronze		5	•
	703	silber / silver	versenkt gebohrt - OHNE EINLAGESTREIFEN countersunk drilled - WITHOUT INSERT STRIP 	5	•
		gold / gold		5	•
		bronze / bronze		5	•
		27 E		Einlagestreifen 27 E (siehe auch Seite 88) Insert strip 27 E (see page 88) schwarz, grau, braun, beige - black, grey, brown, beige	
	101	silber / silver	versenkt gebohrt - OHNE EINLAGESTREIFEN countersunk drilled - WITHOUT INSERT STRIP 	5	•
		sand / sand		5	•
		gold / gold		5	•
		bronze / bronze		5	•
	27 E	Einlagestreifen 27 E (siehe auch Seite 88) Insert strip 27 E (see page 88) schwarz, grau, braun, beige - black, grey, brown, beige			

TREPPENKANTEN und MAUERKANTE in Aluminium für alle Beläge

STAIR-NOSINGS and WALL CORNER in aluminium for all types of floorings

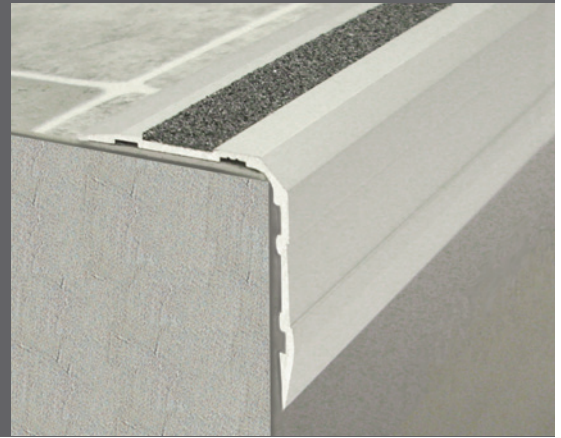

	Artikel-Nr. article-no.	Farbe colour	Beschreibung description	VE unit	Preis/lfm price/lfm 270 cm	Preis/lfm price/lfm 300 cm	Preis/Stück price/piece 150 cm
	110 A	silber / silver	versenkt gebohrt - OHNE EINLAGESTREIFEN countersunk drilled - WITHOUT INSERT STRIP	5	•		
		sand / sand					
		gold / gold					
		bronze / bronze					
	Art. 12 20114	schwarz / black	Art. 12 schwarz / black Einlagestreifen 20114 (siehe auch Seite 88) Insert strip 20114 (see page 88) schwarz, grau / black, grey	5	•		
		anthrazit / anthracite					
	110 B	silber / silver	versenkt gebohrt - OHNE EINLAGESTREIFEN countersunk drilled - WITHOUT INSERT STRIP	5	•		
		gold / gold					
		bronze / bronze					
	1225	schwarz / black	Einlagestreifen 1225 (siehe auch Seite 88) in allen Farben erhältlich (siehe Seite 89) Insert strip 1225 (see page 88) all colours available (see page 89)	5	•		
		hellgrau / light grey					
	1103	silber / silver	ungebohrt - OHNE EINLAGESTREIFEN undrilled - WITHOUT INSERT STRIP	5	•		
		gold / gold					
		bronze / bronze					
	Art. 12 20114	weiß / white	auch als Mauerkante - also wall corner Art. 12 schwarz / black Einlagestreifen 20114 (siehe auch Seite 88) Insert strip 20114 (see page 88) schwarz, grau / black, grey	5	•		
		anthrazit / anthracite					

TREPPENKANTEN in Aluminium für Kunststoff- und Teppichbeläge

STAIR-NOSINGS in aluminium for synthetic and carpet floors

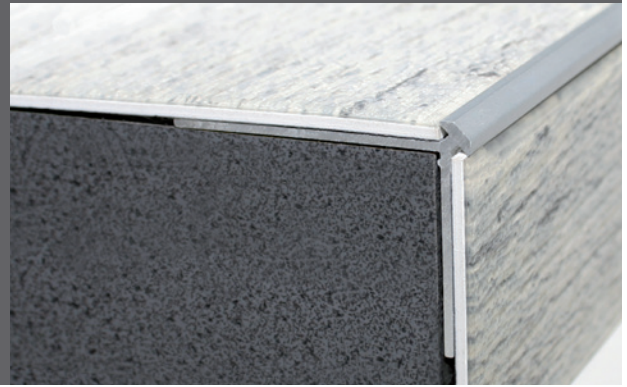

	Artikel-Nr. article-no.	Farbe colour	Beschreibung description	VE unit	Preis/lfm price/lfm 270 cm	Preis/Stange price/unit 270 cm
	109 21	silber / silver	Belaghöhe 2,1 mm, versenkt gebohrt floor height 2,1 mm, countersunk drilled	5	•	
	109 26	silber / silver	Belaghöhe 2,6 mm, versenkt gebohrt floor height 2,6 mm, countersunk drilled	5	•	
NEU / NEW 	109 30	silber / silver	Belaghöhe 3 mm, versenkt gebohrt floor height 3 mm, countersunk drilled	5	•	
NEU / NEW 	109 55	silber / silver	Belaghöhe 5,5 mm, versenkt gebohrt floor height 5,5 mm, countersunk drilled	5	•	

TREPPENKANTEN in Aluminium für Kunststoff- und Teppichbeläge

STAIR-NOSINGS in aluminium for synthetic and carpet floors

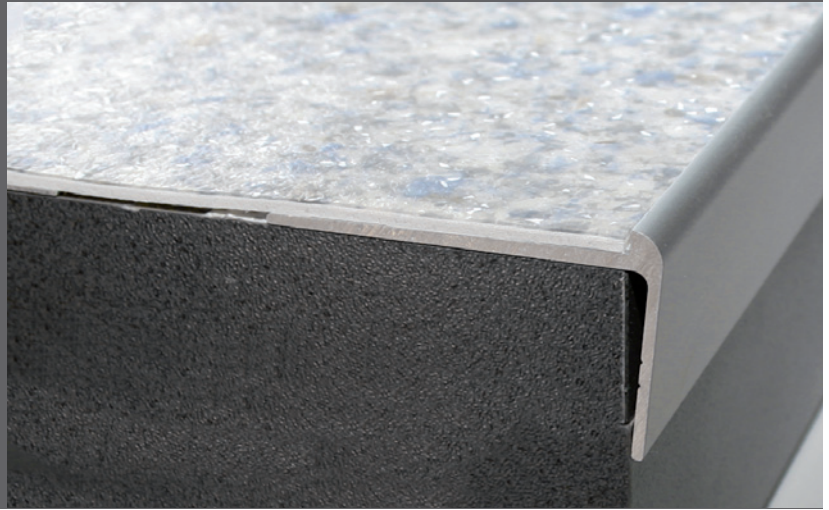

	Artikel-Nr. article-no.	Farbe colour	Beschreibung description	VE unit	Preis/lfm price/lfm 270 cm	Preis/Stange price/unit 270 cm
	109	silber / silver	Treppenkante für Kunststoffböden Belaghöhe 2,8 mm, gebohrt (nicht versenkt) <i>stair noses for synthetic floors</i> floor height 2,8 mm, drilled (not countersunk)stair	5	•	
	109 3A	silber / silver	Belaghöhe 3 mm, versenkt gebohrt floor height 3 mm, countersunk drilled	5	•	
	109 3B	silber / silver	Belaghöhe 2,8 mm, versenkt gebohrt floor height 2,8 mm, countersunk drilled	5	•	

GLEITSCHUTZSTREIFEN Kunststoff, Korund „as“

Achtung: Gleitschutzstreifen aus Kunststoff um ca. 2% länger zuschneiden, bei Verlegung keinesfalls ziehen, sondern stauchen und verkleben! ***Zuschnitt: + 20%**

SYNTHETIC INSERT STRIP, corundum „as“

attention: cut out 2% longer to allow temperature adapting, do not pull when laying, strip can also be glued! *** cut-service +20%**

Farben: siehe Seite 89

colours: see page 89

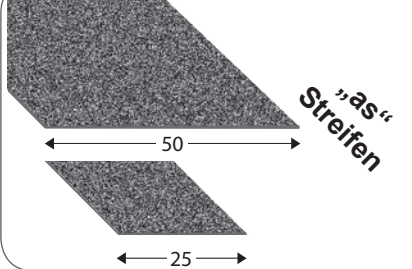
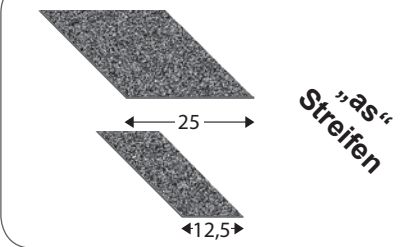
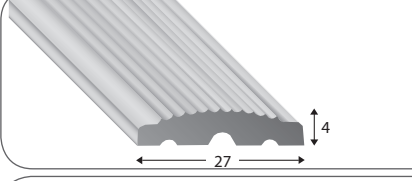
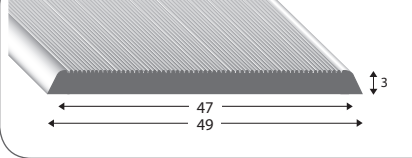
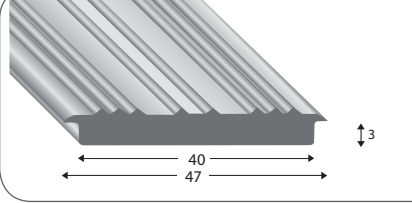
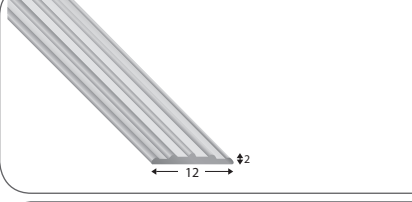
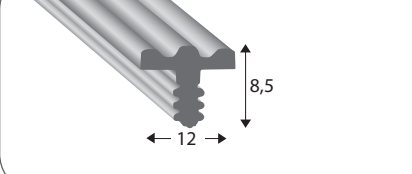
	Artikel-Nr. article-no.	Beschreibung description	VE unit	Preis/Rolle price/rolls
	250	Kunststoff, Korundbeschichtung, selbstklebend <i>synthetic with corundum, self-adhesive</i> Länge 18 m, Breite 50 mm, nur in kompletten Rollen <i>length: 18m, width: 50 mm, complete rolls only</i>	6 Rollen 6 rolls	•
	225	Kunststoff, Korundbeschichtung, selbstklebend <i>synthetic with corundum, self-adhesive</i>	12 Rollen	•
	225 N	nachleuchtend / <i>luminiscent</i> Länge 18 m, Breite 25 mm / <i>length 18 m, width 25 mm</i>	12 rolls	•
	Artikel-Nr. article-no.	Beschreibung description	Preis/lfm price/lfm	
	1225	Kunststoff, Siliciumcarbid, selbstklebend <i>synthetic, siliciumcarbid, self-adhesive</i>	•	
	1125 N	nachleuchtend / <i>luminiscent</i> Breite: 25 mm / <i>width: 25 mm</i> Zuschnitt / <i>cut</i>	•	
	12 Schwarz / <i>black</i>	Kunststoff, Siliciumcarbid, selbstklebend <i>Synthetic, siliciumcarbid, self-adhesive</i> Länge 18 m, Breite 12,5 mm Zuschnitt / <i>length 18m, width 12,5 mm, cut</i> nur schwarz / <i>black only</i>	•	
	27 E	Kunststoff, nicht selbstklebend / <i>synthetic, non self-adhesive</i> Länge 25 m, Breite (ca.) 27 mm / <i>length 25m, width 27 mm</i> gerillt, Farben: schwarz, grau, beige, braun <i>grooved, colours: black, grey, beige, brown</i> *Zuschnitt: + 20% / cut-service + 20%	•	
	50 ST	Kunststoff nicht selbstklebend / <i>synthetic, non self-adhesive</i> Länge 25 m, Breite (ca.) 49 mm / <i>length 25m, width 49 mm</i> fein gerillt, Farben: anthrazit, hellgrau <i>finely-grooved, colour: anthrazite, light grey</i> *Zuschnitt: + 20% / cut-service + 20%	•	
	40 STP	Kunststoff nicht selbstklebend / <i>synthetic, non self-adhesive</i> Länge 25 m, Breite (ca.) 40 mm / <i>length 25m, width 40 mm</i> zum Einfräsen / <i>to be inserted in a gouged out groove</i> Farben: schwarz, grau, beige, braun / <i>colours black, grey, beige, brown</i> Frästiefe 3,5 mm / <i>milling depth 3,5 mm</i> Überstand 4 mm / <i>overlapping lip 4 mm</i> nur in kompletten Rollen / only in complete rolls	•	
	20114	Kunststoff, selbstklebend / <i>synthetic self-adhesive</i> Länge 25 m, Breite (ca.) 12 mm / <i>length 25, width 12 mm</i> fein gerillt / <i>finely-grooved</i> Farben: schwarz, grau / <i>colours: black, grey</i> *Zuschnitt: + 20% / cut-service + 20%	•	
	12/3 STP	Kunststoff nicht selbstklebend / <i>synthetic, non self-adhesive</i> Länge 25 m, Breite (ca.) 12 mm / <i>length 25, width 12 mm</i> zum Einfräsen / <i>to be inserted in a gouged out groove</i> Farben: schwarz, grau, beige, braun / <i>colour: black, grey, beige, brown</i> nur in kompletten Rollen / only in complete rolls	•	

GLEITSCHUTZSTREIFEN - „as“ - anti-slide - selbstklebend und nicht selbstklebend

INSERT STRIP - „as“ - anti-slide, self-adhesive and non self adhesive

„as“ - anti-slide - Gleitschutzstreifen in Kunststoff / synthetic insert strip



FARBKARTE für Einlagestreifen zu Treppen- (Stiegen-) kanten
 COLOUR CARD for insert strips for stair-noses

selbstklebend / self adhesive

Lagerware „as“ Gleitschutzstreifen / on stock „as“ insert strip



01 Schwarz
01 black

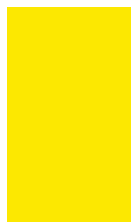

03 Signal-Gelb
03 yellow



04 Transparent
04 transparent



06 Weiß
06 white



07 Grau
07 grey



Gelb-Schwarz
yellow-black



Rot-Weiss
red-white

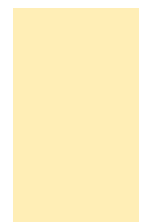

Nachleuchtend
luminiscent

FARBKARTE für 20114
 COLOUR CARD for 20114



schwarz
black



grau
grey

nicht selbstklebend / non self adhesive

Bestellware auf Anfrage / available only on request



13 Rot
13 red



11 Karibik-Marineblau
11 caribbean dark blue



15 Maronibraun
15 chestnutbrown

FARBKARTE für MK 27 E, 40 STP und 12/3 STP
 COLOUR CARD for MK 27 E, 40 STP and 12/3 STP



schwarz
black



grau
grey



braun
brown



beige
beige

FARBKARTE für MK 50 ST
 COLOUR CARD for MK 50 ST



anthrazit
anthracite



hellgrau
light grey

MAUERKANTE - Serie CORNER - in Edelstahl

selbstklebend

WALL PROTECTION PROFILE - Type CORNER - in stainless steel

self adhesive



Artikel-Nr. article-no.	Farbe colour	Beschreibung description	VE unit	Preis/lfm price/lfm 300 cm	Preis/Stange price/unit 150 cm
----------------------------	-----------------	-----------------------------	------------	----------------------------------	--------------------------------------

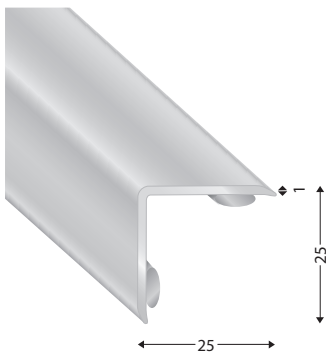

123 CO 25

Edelstahl /
stainless steel

Mauerkantenprofil „CORNER“ selbstklebend,
Winkelmaß außen **25x25x1 mm**
Wall corner profile „CORNER“, self-adhesive,
outer dimension **25x25x1 mm**

Edelstahl / stainless steel
folienverpackt / foiled

10

•

•

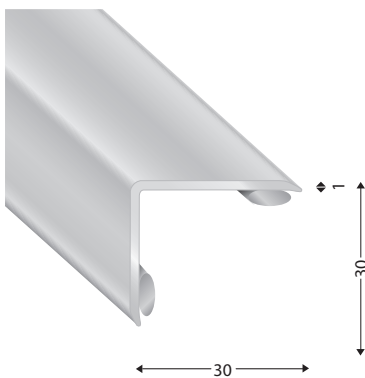

123 CO 30

Edelstahl /
stainless steel

Messing / brass

Mauerkantenprofil „CORNER“ selbstklebend,
Winkelmaß außen **30x30x1 mm**
Wall corner profile „CORNER“, self-adhesive,
outer dimension **30x30x1 mm**

Edelstahl / stainless steel



folienverpackt / foiled

10

•

•

10

•

•

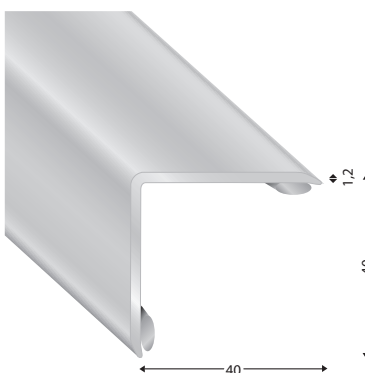

123 CO 40

Edelstahl /
stainless steel

Mauerkantenprofil „CORNER“ selbstklebend,
Winkelmaß außen **40x40x1,2 mm**
Wall corner profile „CORNER“, self-adhesive,
outer dimension **40x40x1,2 mm**

Edelstahl / stainless steel

folienverpackt / foiled

10

•

•

MAUERKANTE und ESTRICHWINKEL

in Aluminium

Mauerkanten / Estrichwinkel glatt und ungebohrt





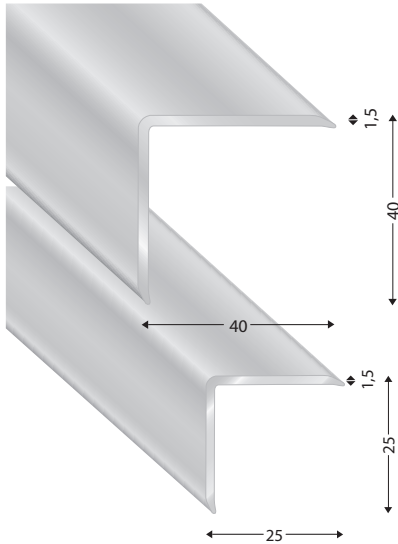
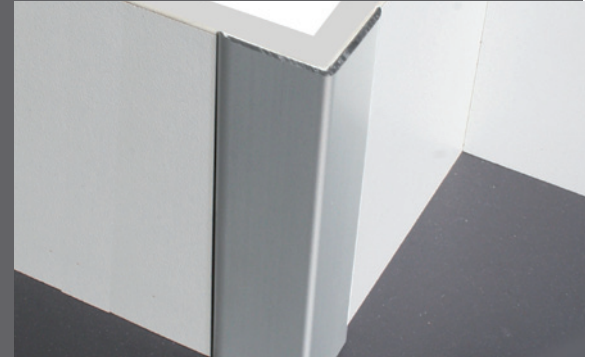



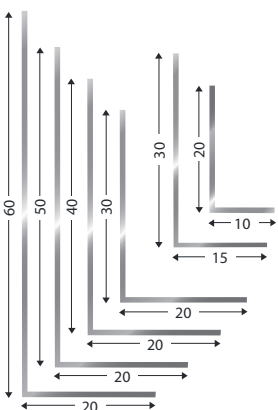
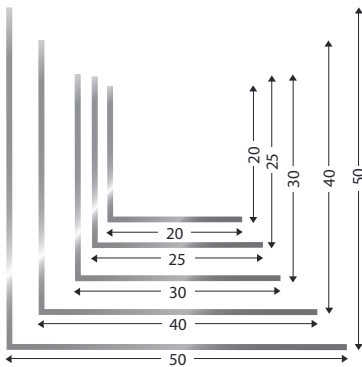



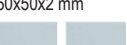

WALL CORNER and ANGLES for SCREED FLOORS in aluminium

Wall protection profile / concrete profile undrilled



ESTRICHWINKEL - ESTRICH DEHNFUGE SCREED PROFILES - JOINTS



Artikel-Nr. article-no.	Farbe colour	Beschreibung description	VE unit	Preis/lfm price/lfm 300 cm	Preis/Stück price/piece 150 cm
123 40	silber / silver	Mauerkantenprofil - Winkelmaß außen 40x40x1,5 mm Wall corner profile - outer dimension 40x40x1,5 mm	10	•	•
	sand / sand		10	•	•
	gold / gold		10	•	•
	EO	Edelstahloptik / stainless steel optic 	10	•	•
123 25	silber / silver	Mauerkantenprofil - Winkelmaß außen 25x25x1,5 mm Wall corner profile - outer dimension 25x25x1,5 mm	10	•	•
	sand / sand		10	•	•
	gold / gold		10	•	•
	EO	Edelstahloptik / stainless steel optic 	10	•	•
		zum Verkleben mit Montagekleber z.B. POWERGRIP for glueing use mounting glue e.g. POWERGRIP			
20202	roh / raw	20x20x2 mm	10		•
	silber / silver		10		•
25252	roh / raw	25x25x2 mm	10		•
	silber / silver		10		•
30302	roh / raw	30x30x2 mm	10		•
	silber / silver		10		•
40402	roh / raw	40x40x2 mm	10		•
	silber / silver		10		•
50502	roh / raw	50x50x2 mm	10		•
	silber / silver		10		•
20102	roh / raw	20x10x2 mm	10		•
	silber / silver		10		•
30152	roh / raw	30x15x2 mm	10		•
	silber / silver		10		•
30202	roh / raw	30x20x2 mm	10		•
	silber / silver		10		•
40202	roh / raw	40x20x2 mm	10		•
	silber / silver		10		•
50202	roh / raw	50x20x2 mm	10		•
	silber / silver		10		•
60202	roh / raw	60x20x2 mm	10		•
	silber / silver		10		•



ALUMINIUM SOCKELLEISTEN

ALUMINIUM SOCKELLEISTEN *ALUMINIUM SKIRTINGS*



SOCKEL- und WANDSCHUTZLEISTEN in Aluminium

SKIRTINGS and WALL PROTECTION PROFILES in aluminium

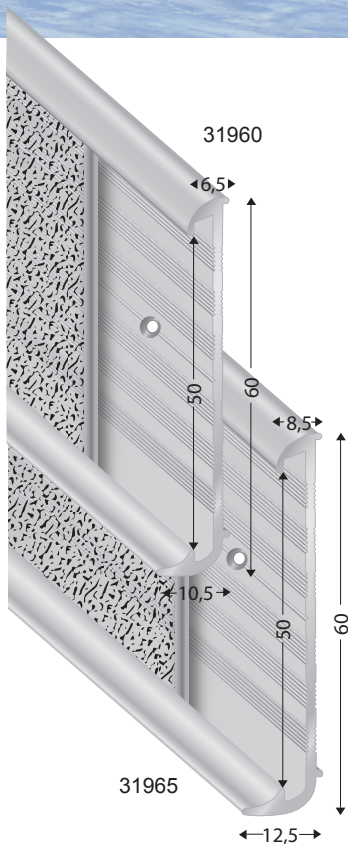
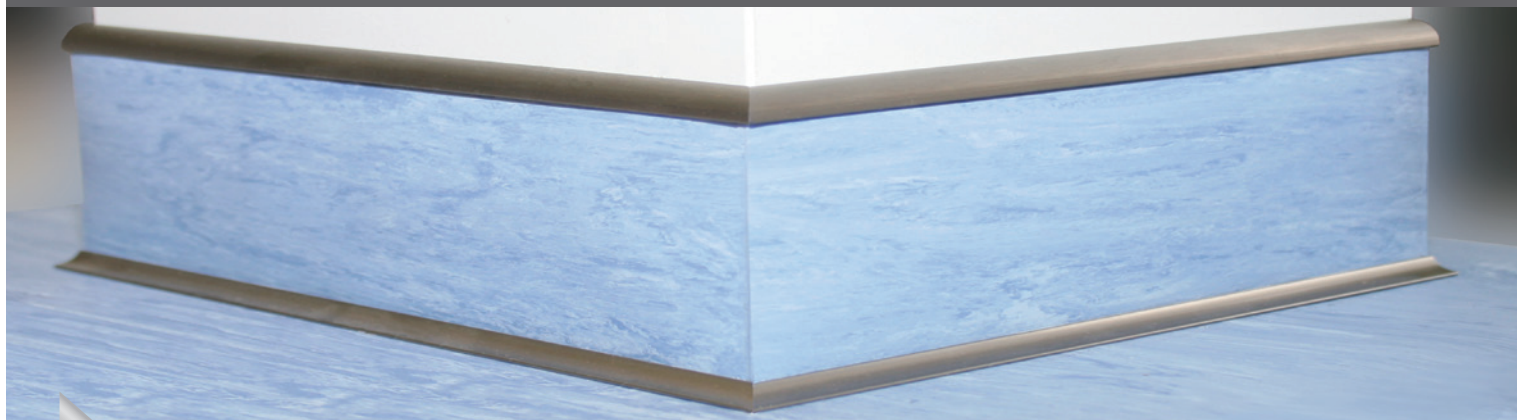

Artikel-Nr. article-no.	Farbe colour	Beschreibung description	VE unit	Preis/lfm price/lfm 270 cm
31960	silber / silver	Versenkt gebohrt oder zum Verkleben, mit Einschub für Kunststoff- oder Teppichbeläge. <i>Countersunk drilled or to be glued for synthetic or carpet floorings.</i> 31960 für Belagstärke bis 3 mm <i>31960 for floor-height up to 3 mm</i>	10	•
	EO	Edelstahloptik / <i>stainless steel optic</i>	10	•
31965	silber / silver	Versenkt gebohrt oder zum Verkleben, mit Einschub für Kunststoff- oder Teppichbeläge. <i>Countersunk drilled or to be glued for synthetic or carpet floorings.</i> 31965 für Belagstärke bis 5 mm <i>31965 for floor-height up to 5 mm</i>	10	•
	EO	Edelstahloptik / <i>stainless steel optic</i>	10	•

ALU SOCKELLEISTE mit Wandabstand 18 mm Alu skirting with 18 mm projection

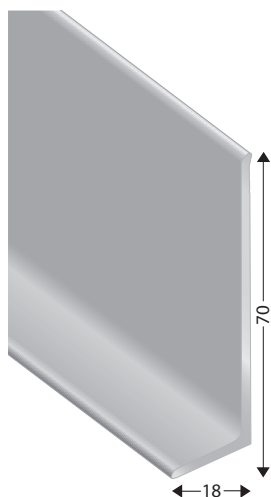

Artikel-Nr. article-no.	Farbe colour	Beschreibung description	VE unit	Preis/lfm price/lfm 270 cm	Preis/lfm price/lfm 400 cm
33670	silber / silver	ungebohrt / undrilled mit größerem Wandabstand 1,6 mm Materialstärke, 18 mm Wandabstand, 70 mm Höhe <i>with greater distance from the wall 1,6 mm material thickness, 18 mm projection, 70 mm height</i>	10	•	•



Zubehör siehe nächste Seite!
Accessories see next page!

SOCKEL- und WANDSCHUTZLEISTEN - ZUBEHÖR 33670 in Aluminium

SKIRTINGS and WALL PROTECTION PROFILES - FITTING 33670 in aluminium

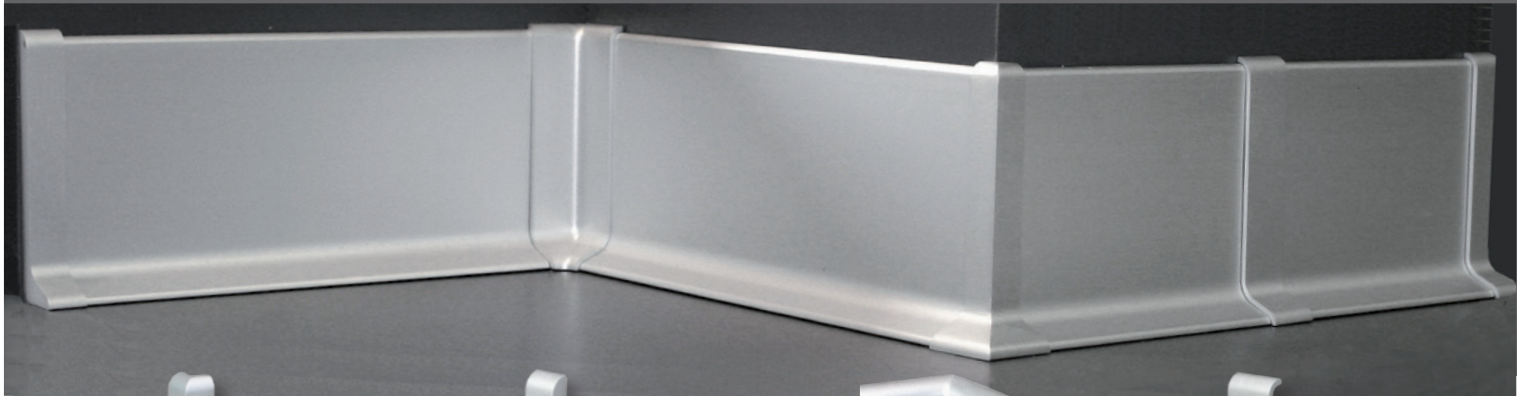

Aussenecke
outside corner



Endkappe links od. rechts
endcaps left or right











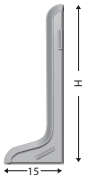

Inneneck
inside corner

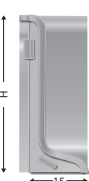

Verbindung
connecting

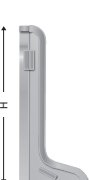
für Artikel 33670 / for article 33670

	Artikel-Nr. article-no.	Farbe colour	Beschreibung description	VE unit	Preis/Stück price/piece
	H= Höhe / height: 70 mm	337 E li	silber / silver Endkappe links / endcaps left 	10	•
	H= Höhe / height: 70 mm	337 E re	silber / silver Endkappe rechts / endcaps right 	10	•
	H= Höhe / height: 70 mm	337 VB	silber / silver Verbindungsstück / connecting unit 	10	•
	H= Höhe / height: 70 mm	337 IE	silber / silver Inneneck / inside corner 	10	•
	H= Höhe / height: 70 mm	337 AE	silber / silver Ausseneck / outside corner 	10	•

SOCKEL- und WANDSCHUTZLEISTEN in Aluminium und Edelstahl

SKIRTINGS and WALL PROTECTION PROFILES in aluminium and stainless steel



Alle RAL-Farben ab 1 Bund möglich, Preis auf Anfrage!
 Spezial RAL-colours available from 1 bundel, price on request!

Zuschlag selbstklebend ab 1 Bund möglich, Preis auf Anfrage!
 Self-adhesive available from 1 bundle, price on request!

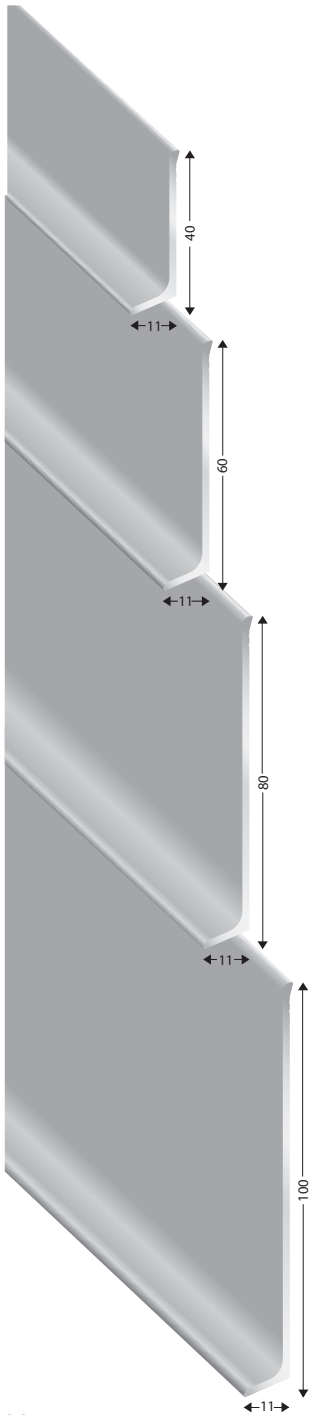

Artikel-Nr. article-no.	Farbe colour	Beschreibung description	VE unit	Preis/lfm price/lfm 270 cm	Preis/lfm price/lfm 400 cm	Preis/Stange price/unit 250 cm
31640	silber / silver sand / sand gold / gold bronze / bronze weiß / white EO	ungebohrt / undrilled 1,6 mm Materialstärke, 11 mm Wandabstand, 40 mm Höhe 1,6 mm material thickness, 11 mm projection, 40 mm height	10	•	•	
			10	•	•	
			10	•	•	
			10	•	•	
			10	•	•	
			10	•	•	
10	Edelstahl / stainless steel	Edelstahloptik / stainless steel optic	10	•		•
RAL Farben auf Anfrage / RAL colours on request						
31660	silber / silver sand / sand gold / gold bronze / bronze weiß / white EO	ungebohrt / undrilled 1,6 mm Materialstärke, 11 mm Wandabstand, 60 mm Höhe 1,6 mm material thickness, 11 mm projection, 60 mm height	10	•	•	
			10	•	•	
			10	•	•	
			10	•	•	
			10	•	•	
			10	•	•	
10	Edelstahl / stainless steel	Edelstahloptik / stainless steel optic	10	•		•
RAL Farben auf Anfrage / RAL colours on request						
31680	silber / silver gold / gold bronze / bronze weiß / white EO	ungebohrt / undrilled 1,6 mm Materialstärke, 11 mm Wandabstand, 80 mm Höhe 1,6 mm material thickness, 11 mm projection, 80 mm height	10	•	•	
			10	•	•	
			10	•	•	
			10	•	•	
			10	•	•	
			10	•	•	
10	Edelstahl / stainless steel	Edelstahloptik / stainless steel optic	10	•	•	
RAL Farben auf Anfrage / RAL colours on request						
31610	silber / silver weiß / white EO	ungebohrt / undrilled 1,6 mm Materialstärke, 11 mm Wandabstand - 100 mm Höhe 1,6 mm material thickness, 11 mm projection - 100 mm height	10	•	•	
			10	•	•	
			10	•	•	
RAL Farben auf Anfrage / RAL colours on request						

SOCKEL- und WANDSCHUTZLEISTEN - ZUBEHÖR Serie 31600

in Aluminium

SKIRTINGS and WALL PROTECTION PROFILES - FITTING for serie 31600

in aluminium

Endkappe links od. rechts
endcaps left or right



Aussenecke
outside corner

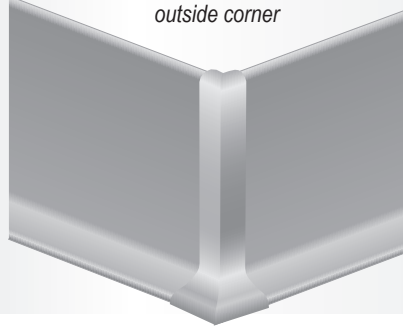

Inneneck
inside corner

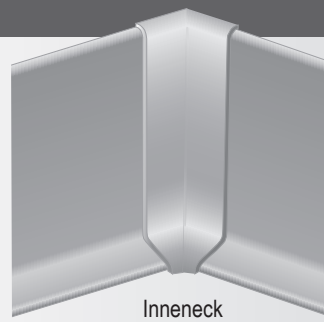

Verbindung
connecting

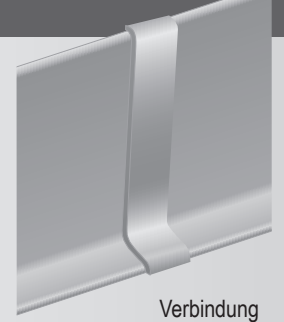





für Artikel 31600 / for article 31600

	Artikel-Nr. article-no.	Farbe colour	Beschreibung description	VE unit	Preis/Stück price/piece
	H= Höhe / height: 40 mm	314 E li	silber / silver weiss / white EO	Edelstahloptik / stainless steel optic	10 •
	H= Höhe / height: 60 mm	316 E li	silber / silver weiss / white EO	Edelstahloptik / stainless steel optic	10 •
	H= Höhe / height: 80 mm	318 E li	silber / silver weiss / white EO	Edelstahloptik / stainless steel optic	10 •
	H=Höhe / height: 100 mm	310 E li	silber / silver EO	Edelstahloptik / stainless steel optic	10 •
	H= Höhe / height: 40 mm	314 E re	silber / silver weiss / white EO	Edelstahloptik / stainless steel optic	10 •
	H= Höhe / height: 60 mm	316 E re	silber / silver weiss / white EO	Edelstahloptik / stainless steel optic	10 •
	H= Höhe / height: 80 mm	318 E re	silber / silver weiss / white EO	Edelstahloptik / stainless steel optic	10 •
	H=Höhe / height: 100 mm	310 E re	silber / silver EO	Edelstahloptik / stainless steel optic	10 •
	H= Höhe / height: 40 mm	314 VB	silber / silver weiss / white EO	Edelstahloptik / stainless steel optic	10 •
	H= Höhe / height: 60 mm	316 VB	silber / silver weiss / white EO	Edelstahloptik / stainless steel optic	10 •
	H= Höhe / height: 80 mm	318 VB	silber / silver weiss / white EO	Edelstahloptik / stainless steel optic	10 •
	H=Höhe / height: 100 mm	310 VB	silber / silver EO	Edelstahloptik / stainless steel optic	10 •
	H= Höhe / height: 40 mm	314 IE	silber / silver weiss / white EO	Edelstahloptik / stainless steel optic	10 •
	H= Höhe / height: 60 mm	316 IE	silber / silver weiss / white EO	Edelstahloptik / stainless steel optic	10 •
	H= Höhe / height: 80 mm	318 IE	silber / silver weiss / white EO	Edelstahloptik / stainless steel optic	10 •
	H=Höhe / height: 100 mm	310 IE	silber / silver EO	Edelstahloptik / stainless steel optic	10 •
	H= Höhe / height: 40 mm	314 AE	silber / silver weiss / white EO	Edelstahloptik / stainless steel optic	10 •
	H= Höhe / height: 60 mm	316 AE	silber / silver weiss / white EO	Edelstahloptik / stainless steel optic	10 •
	H= Höhe / height: 80 mm	318 AE	silber / silver weiss / white EO	Edelstahloptik / stainless steel optic	10 •
	H=Höhe / height: 100 mm	310 AE	silber / silver EO	Edelstahloptik / stainless steel optic	10 •

„CONTEGO“ - SOCKEL- und WANDSCHUTZLEISTEN in Aluminium

„CONTEGO“ - SKIRTINGS and WALL PROTECTION PROFILES in aluminium

	Artikel-Nr. article-no.	Farbe colour	Beschreibung description	VE unit	Preis/lfm price/lfm 400 cm
	99204 111120	silber / silver	Design-Sockelleiste „CONTEGO“ 40x11mm Design-skirting „CONTEGO“ 40x11mm  Die Montage wird mit den verdeckten und höhenverstellbaren Clips empfohlen. Das Profil kann auch geklebt oder geschraubt werden.	5	•
	99206 111120	silber / silver	Design-Sockelleiste „CONTEGO“ 60x11mm Design-skirting „CONTEGO“ 60x11mm  Die Montage wird mit den verdeckten und höhenverstellbaren Clips empfohlen. Das Profil kann auch geklebt oder geschraubt werden.	5	•
	99206 151520	silber / silver	Design-Sockelleiste „CONTEGO“ 60x15mm Design-skirting „CONTEGO“ 60x15mm  Die Montage wird mit den verdeckten und höhenverstellbaren Clips empfohlen. Das Profil kann auch geklebt oder geschraubt werden.	5	•
	99210 111120	silber / silver	Design-Sockelleiste „CONTEGO“ 100x11mm Design-skirting „CONTEGO“ 100x11mm  Die Montage wird mit den verdeckten und höhenverstellbaren Clips empfohlen. Das Profil kann auch geklebt oder geschraubt werden.	5	•

„CONTEGO“ - ZUBEHÖR in Aluminium

„CONTEGO“ - FITTING in aluminium





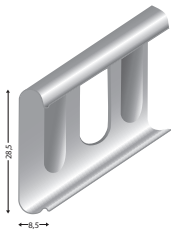

Artikel-Nr. article-no.	Farbe colour	Beschreibung description	VE/Rolle VE/rolls	Preis/Rolle price/rolls
99200 05		Gummilippe zu CONTEGO Clip 11 mm metallic <i>Sealing lip for CONTEGO Clip 11 mm metallic</i>	20 m	•

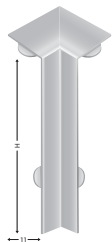





Artikel-Nr. article-no.	Farbe colour	Beschreibung description	VE unit	Preis/100 Stück price/100 piece
99200 95		Montageclip zu CONTEGO inkl. Schrauben und Dübel <i>Installations clip for CONTEGO incl. screws and dowel</i>	100	•







Artikel-Nr. article-no.	Farbe colour	Beschreibung description	VE unit	Preis/Stück price/piece
99295 041120	silber / silver	Innenecke / <i>inside corner</i> „CONTEGO“ 40x11 mm	 S	10
99295 061120	silber / silver	Innenecke / <i>inside corner</i> „CONTEGO“ 60x11 mm	 S	10
99195 061515	silber / silver	Innenecke / <i>inside corner</i> „CONTEGO“ 60x15 mm	 S	10
99295 101120	silber / silver	Innenecke / <i>inside corner</i> „CONTEGO“ 100x11 mm	 S	10







99296 041120	silber / silver	Aussenecke / <i>outside corner</i> „CONTEGO“ 40x11 mm	 S	10
99296 061120	silber / silver	Aussenecke / <i>outside corner</i> „CONTEGO“ 60x11 mm	 S	10
99196 061515	silber / silver	Aussenecke / <i>outside corner</i> „CONTEGO“ 60x15 mm	 S	10
99296 101120	silber / silver	Aussenecke / <i>outside corner</i> „CONTEGO“ 100x11 mm	 S	10







99298 041120	silber / silver	Endkappe rechts / <i>endcaps right</i> „CONTEGO“ 40x11 mm	 S	10
99298 061120	silber / silver	Endkappe rechts / <i>endcaps right</i> „CONTEGO“ 60x11 mm	 S	10
99198 061515	silber / silver	Endkappe rechts / <i>endcaps right</i> „CONTEGO“ 60x15 mm	 S	10
99298 101120	silber / silver	Endkappe rechts / <i>endcaps right</i> „CONTEGO“ 100x11 mm	 S	10

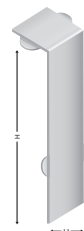

99297 041120	silber / silver	Endkappe links / <i>endcaps left</i> „CONTEGO“ 40x11 mm	 S	10
99297 061120	silber / silver	Endkappe links / <i>endcaps left</i> „CONTEGO“ 60x11 mm	 S	10
99197 061515	silber / silver	Endkappe links / <i>endcaps left</i> „CONTEGO“ 60x15 mm	 S	10
99297 101120	silber / silver	Endkappe links / <i>endcaps left</i> „CONTEGO“ 100x11 mm	 S	10



99299 041120	silber / silver	Verbindungsstück / <i>connecting unit</i> „CONTEGO“ 40x11 mm	 S	10
99299 061120	silber / silver	Verbindungsstück / <i>connecting unit</i> „CONTEGO“ 60x11 mm	 S	10
99199 061515	silber / silver	Verbindungsstück / <i>connecting unit</i> „CONTEGO“ 60x15 mm	 S	10
99299 101120	silber / silver	Verbindungsstück / <i>connecting unit</i> „CONTEGO“ 100x11 mm	 S	10

„tim“ - 2-teilige ALUMINIUMSOCKELLEISTE und ZUBEHÖR für 31270

„tim“ - 2 part - ALUMINIUM SKIRTINGS and fittings for 31270

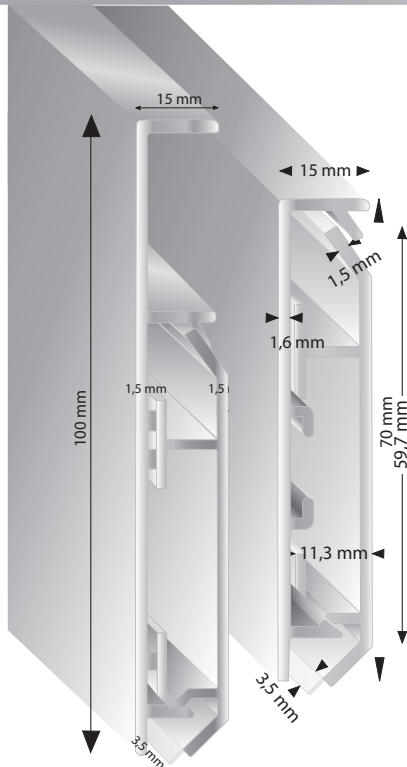
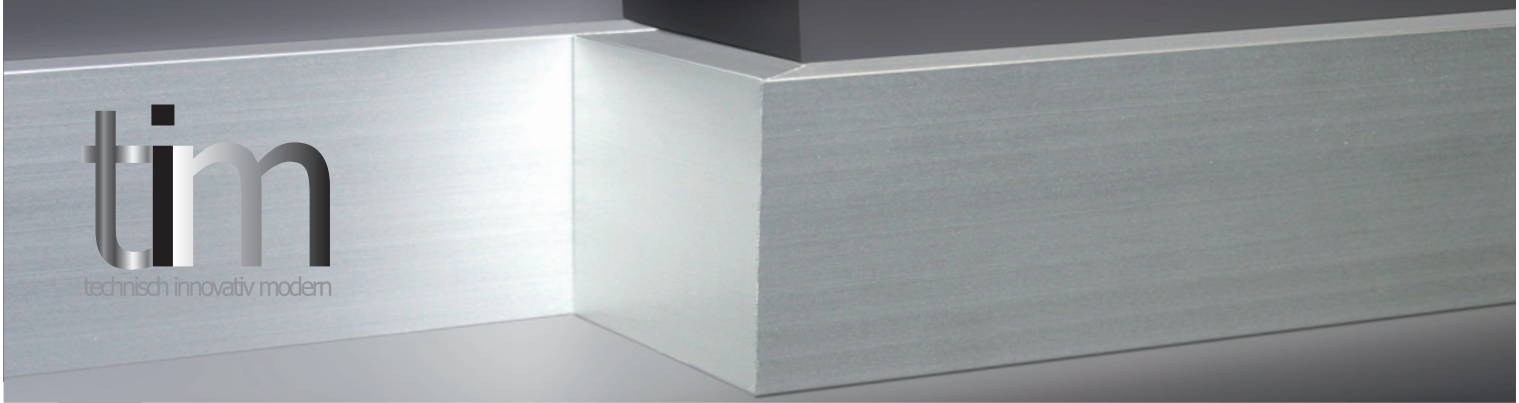

Artikel-Nr. article-no.	Farbe colour	Beschreibung description	VE unit	Preis/lfm price/lfm 270 cm	Preis/lfm price/lfm 400 cm
31270	silber / silver	Alu Sockelleiste komplett mit durchgehendem Kunststoff-Grundprofil und transparenter Boden-Dichtlippe S RAL - Farben auf Anfrage RAL - Colours on request Höhe / height 70 mm Alu skirting incl. continuous synthetic base profile with transparent bottom sealing lip	10	•	•
	EO	Edelstahloptik / stainless steel optic	10	•	
31210	silber / silver	Höhe / height 100 mm S RAL - Farben auf Anfrage RAL - Colours on request	10	•	
	EO	Edelstahloptik / stainless steel optic	10	•	

NEU / NEW

RAL Beschichtung auf Anfrage - Minimum Verrechnungsmenge 81 lfm
RAL coating on request - Minimum charge for coating (only) 81 lfm

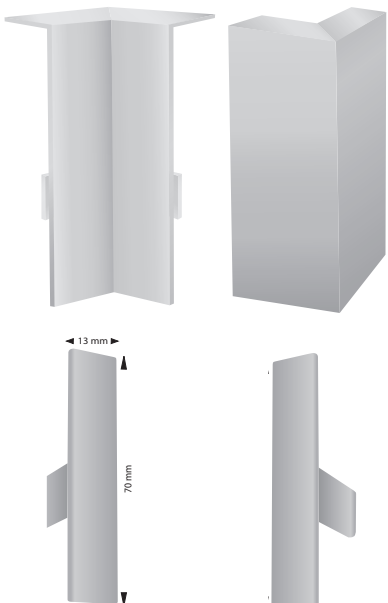

Artikel-Nr. article-no.	Farbe colour	Beschreibung description	VE unit	Preis/Stück price/piece
tim 70 IE	silber / silver	Synthetische Innenecken für 31270 inner-corner in synthetic for article 31270 S	10	•
tim 70 AE	silber / silver	Synthetische Aussenecken für 31270 outside corner in synthetic for article 31270 S	10	•
Artikel-Nr. article-no.	Farbe colour	Beschreibung description	VE unit	Preis/Paar price/pair
tim 70 E	silber / silver	Synthetische Endkappe links und rechts für 31270 endcaps in synthetic left and right for article 31270 S	10	•

ALUBAND und SÄULENRINGE in ALUMINIUM

ALU FLATPROFILE and ALU-RINGS in aluminium



NEU / NEW

Artikel-Nr.
article-no.

Farbe
colour

Beschreibung
description

Preis/Stück
price/piece

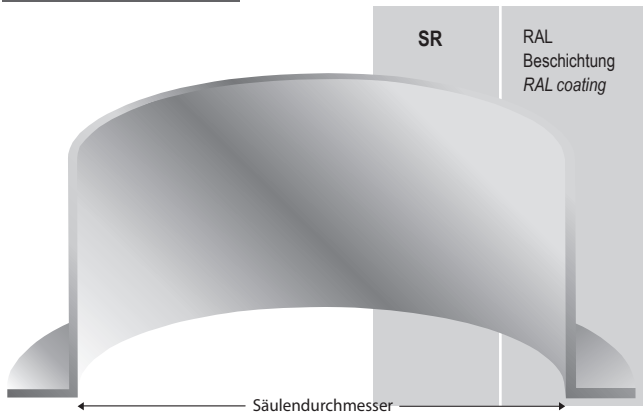

SR

RAL
Beschichtung
RAL coating

ALUMINIUMSÄULEN -
Größen nach Objektangaben
maximale Ringgröße Ø 75 cm
kleinstmögliche Ringgröße Ø 20 cm

*ALU-RINGS for pillars
measures on request
max. size Ø 75 cm
min. size Ø 20 cm*

SONDERANFERTIGUNG!
Custom made on request!

Preis auf Anfrage
Price on request

Artikel-Nr.
article-no.

Farbe
colour

Beschreibung
description

VE
unit

Preis/Stück
price/piece
400 cm

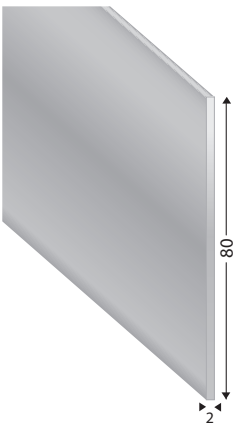

802

silber / silver

ALU-FLACHBAND
ALU FLAT PROFILE
80 x 2 mm



10

Artikel-Nr.
article-no.

Farbe
colour

Beschreibung
description

VE
unit

Preis/Stück
price/piece
400 cm



50132

silber / silver

SPEZIALWINKEL 50x13x2 mm
SPECIAL ANGLE 50x13x2 mm



10

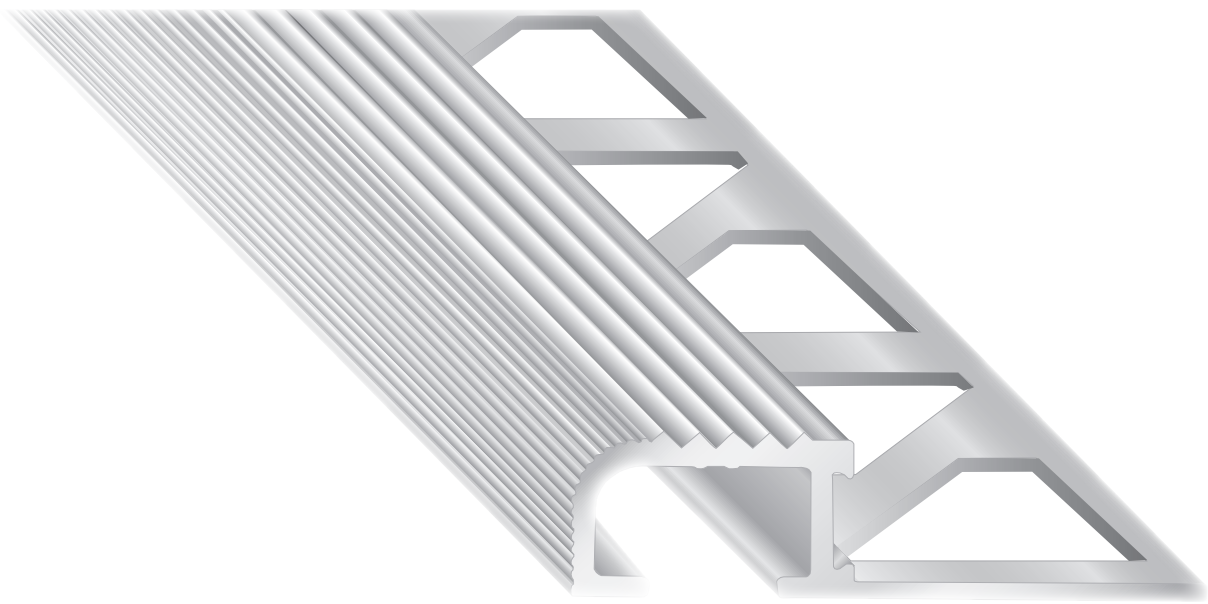

FLIESENPROFILE

FLIESENPROFILE *PROFILES FOR CERAMIC TILES*



FLIESENPROFILE „FLIP“ in Aluminium, Messing, Edelstahl und Kunststoff für keramische Fliesen, Stein und PVC

PROFILES FOR CERAMIC TILES „FLIP“ in aluminium, brass, stainless steel and synthetic

for ceramic tiles, stone and PVC

FARBTABELLE Alu, Messing und Edelstahl

COLOURCARD for alu, messing and stainless steel

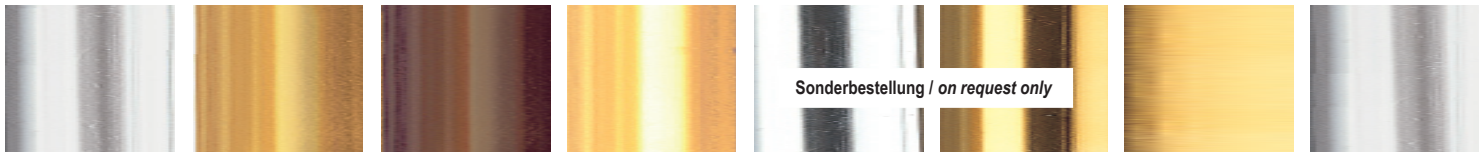

S = Alu silber / alu silver
R = Alu roh / alu raw

G = Alu gold / alu gold

B = Alu bronze / alu bronze

SD = Alu sand / alu sand

ASB = Alu chrom glänzend / alu chemical polished

AOB = Alu gold brilliant / alu gold brilliant

M = Messing / brass

E = Edelstahl / stainless steel
EO = Edelstahloptik / stainless steel optic

FARBTABELLE Aluminium pulverbeschichtet für Modell Flip 118, 119 und 122

COLOURCARD aluminium coated for model Flip 118, 119 and 122



BH = bahamabeige
BH = bahamabeige

MH = manhattan
MH = manhattan

KR = krokus
KR = crocus

BB = blassbeige
BB = light beige

W = weiß
W = white

jede RAL-Farbe lieferbar auf Anfrage - ab 81 m
each RAL-colour on request - min. quant. 81 m

FARBTABELLE Kunststoff für Modell Flip 1119, 2118

COLOURCARD synthetic for model Flip 1119, 2118

11 weiß
11 white

21 manhattan
21 manhattan

31 hellbeige
31 light beige

32 dunkelbeige
32 dark beige

41 creme
41 creme

43 pfirsich
43 apricot

44 magnolie
44 magnolia

45 krokus
45 crocus

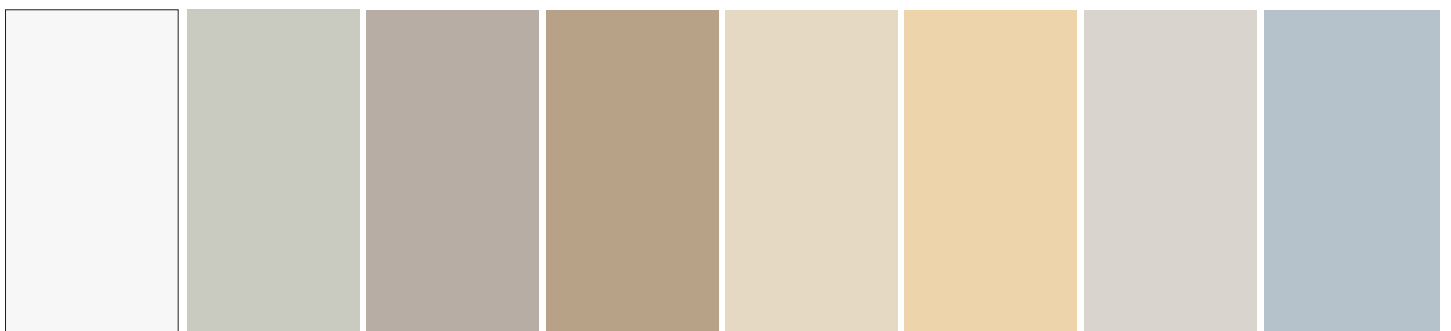

„FLIP“ - Serie RONDO - FLIESENPROFILE in Aluminium, Messing, und Edelstahl

„FLIP“ - type RONDO - PROFILES FOR CERAMIC TILES „FLIP“ in aluminium, brass and stainless steel

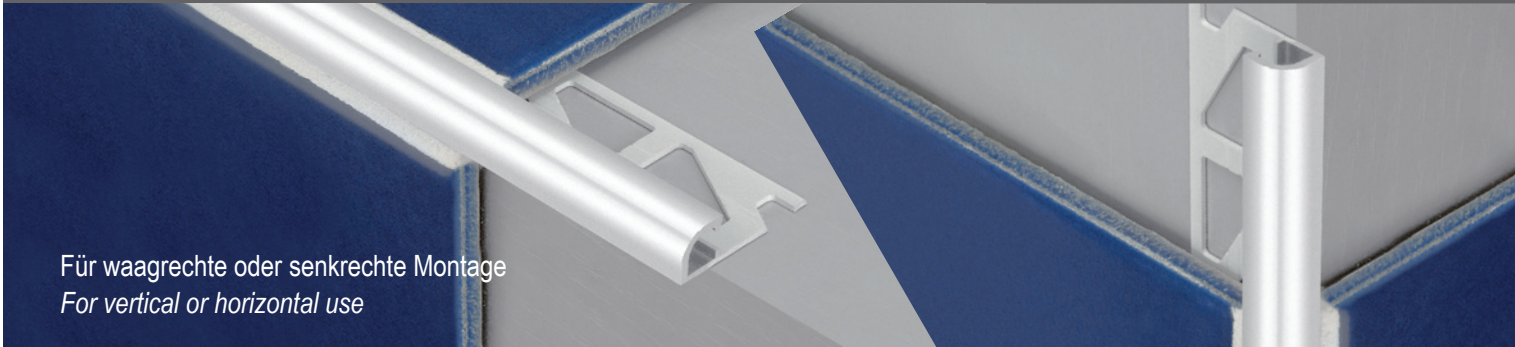

Für waagrechte oder senkrechte Montage
For vertical or horizontal use

	Artikel-Nr. article-no.	Farbe colour	Beschreibung description	VE unit	Preis/lfm price/lfm 270 cm	Preis/lfm price/lfm 300 cm
<p>als waagrechter Abschluß as horizontal end profile</p>						
<p>als senkrechte Kante as vertical edge</p>						
<p>als waagrechte Kante as wall edge</p>						
	118 6	silber / silver gold / gold bronze / bronze E BB BH MH W	„Rondo“ Alu-Fliesenprofil - Innenhöhe 6 mm „Rondo“ profile for ceramic - inner-height 6 mm S G B E BB BH MH W	10 10 10 10 10 10 10 10	• • • • • • • •	• • • • • • • •
	118 8	silber / silver gold / gold bronze / bronze E BB KR W ASB M	„Rondo“ Alu-Fliesenprofil - Innenhöhe 8 mm „Rondo“ profile for ceramic - inner-height 8 mm S G B E BB KR W ASB M	10 10 10 10 10 10 10 10	• • • • • • • •	• • • • • • • •
	118 10	silber / silver gold / gold bronze / bronze E KR MH W ASB AOB M	„Rondo“ Alu-Fliesenprofil - Innenhöhe 10 mm „Rondo“ profile for ceramic - inner-height 10 mm S G B E KR MH W AOB ASB M	10 10 10 10 10 10 10 10 10 10	• • • • • • • • • •	• • • • • • • •
	118 12	silber / silver roh / raw E W	„Rondo“ Alu-Fliesenprofil - Innenhöhe 12,5 mm „Rondo“ profile for ceramic - inner-height 12,5 mm S roh E W	10 10 10 10	• • • •	• • • •

Unverbindlich empfohlene Verkaufspreise inkl. Ust. gültig ab 10/2014

„FLIP“ - Serie RONDO und PUNTO - FLIESENPROFILE in Kunststoff

„FLIP“ - type RONDO and PUNTO - PROFILES FOR CERAMIC TILES in synthetic

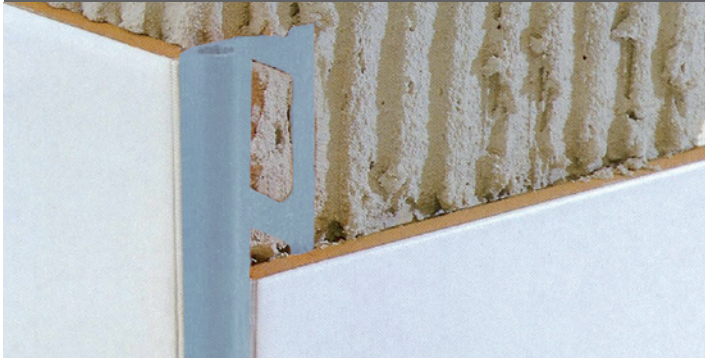

Für waagrechte oder senkrechte Montage
For vertical or horizontal use



als waagrechter Abschluß
as horizontal end profile



als senkrechte Kante
as vertical edge



als waagrechte Kante
as wall edge

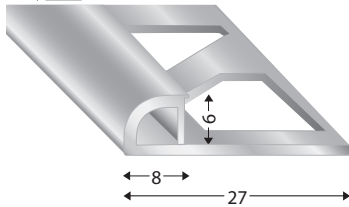

Artikel-Nr. article-no.	Farbe colour	Beschreibung description	VE unit	Preis/lfm price/lfm 270 cm	Preis/lfm price/lfm 300 cm
2118 6	11	„Rondo“ Kunststoff-Fliesenprofil, Innenhöhe 6 mm „Rondo“ synthetic-profile for ceramic - inner-height 6 mm 11 21 31 32 41 44 	10	•	•
	21		10	•	
	31		10	•	
	32		10	•	
	41		10	•	
	44		10	•	

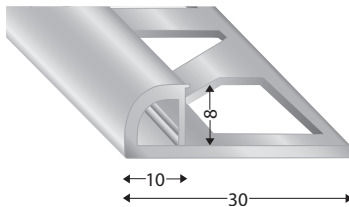

2118 8	11	„Rondo“ Fliesenprofil, Innenhöhe 8 mm „Rondo“ synthetic-profile for ceramic - inner-height 8 mm 11 21 31 32 41 43 44 45 	10	•	•
	21		10	•	
	31		10	•	
	32		10	•	
	41		10	•	
	43		10	•	
	44		10	•	
	45		10	•	

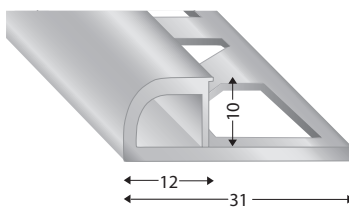

2118 10	11	„Rondo“ Kunststoff-Fliesenprofil, Innenhöhe 10 mm „Rondo“ synthetic-profile for ceramic - inner-height 10 mm 11 21 31 32 41 43 44 45 	10	•	•
	21		10	•	
	31		10	•	
	32		10	•	
	41		10	•	
	43		10	•	
	44		10	•	
	45		10	•	

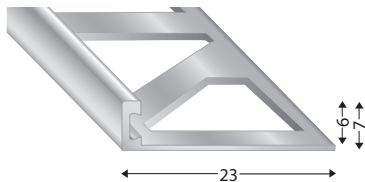

1119 6	11	„Punto“ Kunststoff-Fliesenprofil, Innenhöhe 6 mm „Punto“ synthetic-profile for ceramic - inner-height 6 mm 11 21 31 	10	•	•
	21		10	•	
	31		10	•	

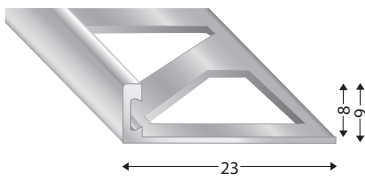



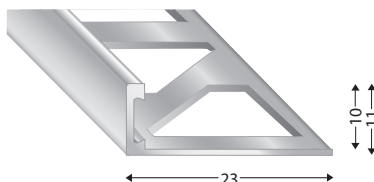



1119 8	11	„Punto“ Fliesenprofil, Innenhöhe 8 mm „Punto“ synthetic-profile for ceramic - inner height 8 mm 11 21 31 	10	•	•
	21		10	•	
	31		10	•	



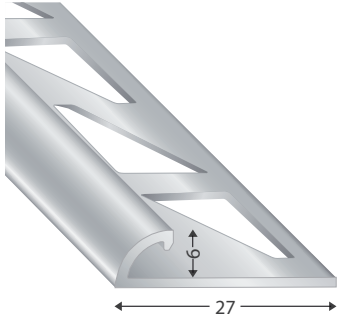

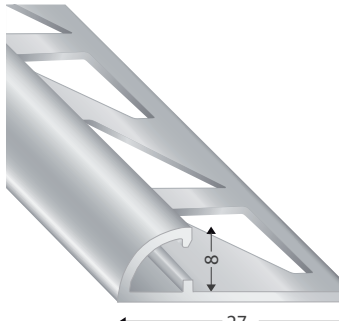

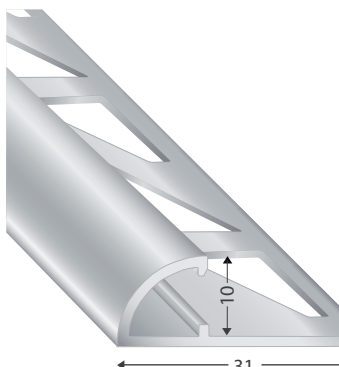
1119 10	11	„Punto“ Kunststoff-Fliesenprofil, Innenhöhe 10 mm „Punto“ synthetic-profile for ceramic - inner height 10 mm 11 21 31 	10	•	•
	21		10	•	
	31		10	•	

„FLIP“ - Serie RONDO - FLIESENPROFILE in Aluminium

„FLIP“ - type RONDO - PROFILES FOR CERAMIC TILES in aluminium

	Artikel-Nr. article-no.	Farbe colour	Beschreibung description	VE unit	Preis/Stange price/unit 300 cm
	218 6	silber / silver	„Rondo“ Alu-Fliesenprofil - Innenhöhe 6 mm	10	•
		gold / gold	„Rondo“ profile for ceramic - inner-height 6 mm	10	•
		weiss / white		10	•
	218 8	silber / silver	„Rondo“ Alu-Fliesenprofil - Innenhöhe 8 mm	10	•
		gold / gold	„Rondo“ profile for ceramic - inner-height 8 mm	10	•
		weiss / white		10	•
	218 10	silber / silver	„Rondo“ Alu-Fliesenprofil - Innenhöhe 10 mm	10	•
		gold / gold	„Rondo“ profile for ceramic - inner-height 10 mm	10	•
		weiss / white		10	•

	Artikel-Nr. article-no.	Farbe colour	Beschreibung description	VE/Blister unit/blister	Preis/Paar price/pair
	218 E 6	silber / silver	„Rondo“ Endstücke	1 links + 1 rechts	in Vorbereitung in preparation
		weiss / white	„Rondo“ endcaps	1 left + 1 right	
				10	
	218 E 8	silber / silver		10	in Vorbereitung in preparation
		weiss / white		10	
	218 E 10	silber / silver		10	in Vorbereitung in preparation
		weiss / white		10	

„FLIP“ - Serie PRIMO - FLIESENPROFILE in Aluminium, Messing und Edelstahl

„FLIP“ - type PRIMO - PROFILES FOR CERAMIC TILES in aluminium, brass and stainless steel

Für waagrechte oder senkrechte Montage
For vertical or horizontal use

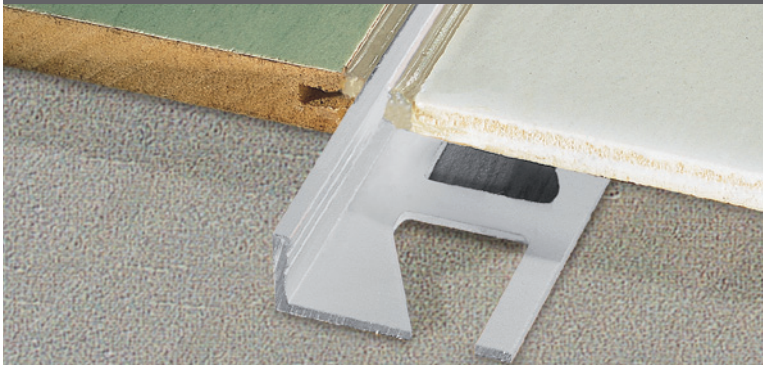

als waagrechte Kante
as wall edge

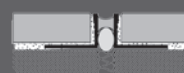

als Dehnfuge
as expansion joint



als Übergang
as end moulding for floors



als Mauerkante
as wall edge

als waagrechter Abschluß
as horizontal end profile

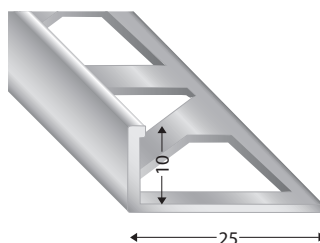
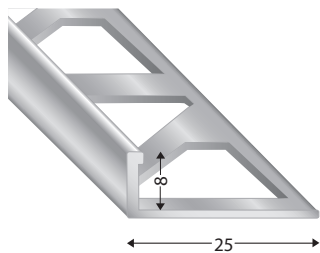
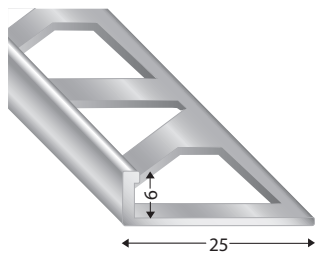
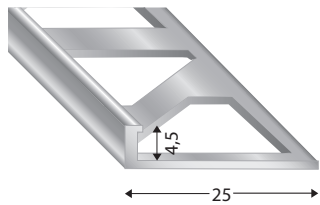
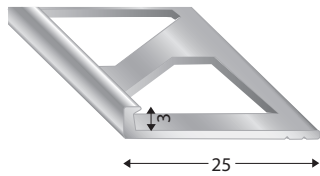
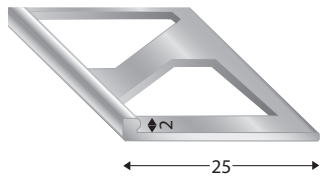

Artikel-Nr. article-no.	Farbe colour	Beschreibung description	VE unit	Preis/lfm price/lfm 250 cm	Preis/lfm price/lfm 270 cm	Preis/lfm price/lfm 300 cm
119 2	silber / silver ROH / raw	„Primo“ Alu-Fliesenprofil, Innenhöhe 2 mm „Primo“ alu-profile for ceramic - inner-height 2 mm	10			•
			10	•		•
119 3	silber / silver ROH / raw	„Primo“ Alu-Fliesenprofil, Innenhöhe 3 mm „Primo“ alu-profile for ceramic - inner-height 3 mm	10			•
			10	•		•
119 4,5	silber / silver ROH / raw	„Primo“ Alu-Fliesenprofil, Innenhöhe 4,5 mm „Primo“ alu-profile for ceramic - inner-height 4,5 mm	10			•
			10	•		•
119 6	silber / silver gold / gold bronze / bronze ROH / raw MH W	„Primo“ Alu-Fliesenprofil, Innenhöhe 6 mm „Primo“ alu-profile for ceramic - inner-height 6 mm	10			•
			10			•
			10			•
			10	•	•	•
			10			•
			10	•	•	•
119 8	silber / silver gold / gold bronze / bronze ROH / raw MH W	„Primo“ Alu-Fliesenprofil, Innenhöhe 8 mm „Primo“ alu-profile for ceramic - inner-height 8 mm	10			•
			10			•
			10			•
			10	•	•	•
			10			•
			10	•	•	•
119 10	silber / silver gold / gold bronze / bronze ROH / raw MH W	„Primo“ Alu-Fliesenprofil, Innenhöhe 10 mm „Primo“ alu-profile for ceramic - inner-height 10 mm	10			•
			10			•
			10			•
			10	•	•	•
			10			•
			10	•	•	•

„FLIP“ - Serie PRIMO - FLIESENPROFILE in Aluminium, Messing und Edelstahl

„FLIP“ - type PRIMO - PROFILES FOR CERAMIC TILES in aluminium, brass and stainless steel

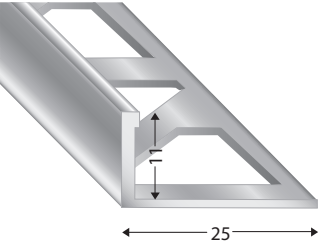
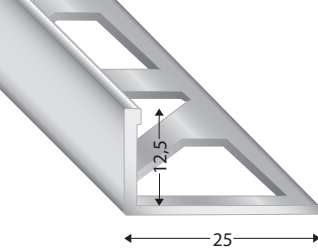
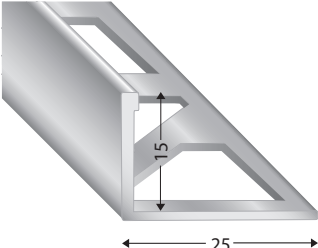
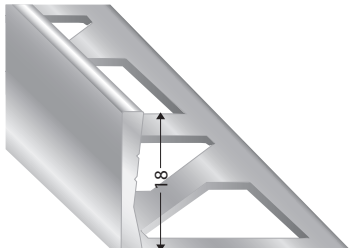
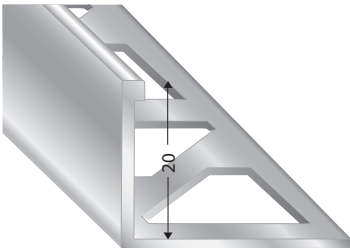
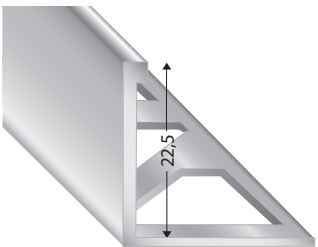
	Artikel-Nr. article-no.	Farbe colour	Beschreibung description	VE unit	Preis/lfm price/lfm 250 cm	Preis/lfm price/lfm 270 cm	Preis/lfm price/lfm 300 cm
	119 11	silber / silver gold / gold bronze / bronze	„Primo“ Alu-Fliesenprofil, Innenhöhe 11 mm „Primo“ alu-profile for tiles - inner-height 11 mm S G B E	10 10 10 10			• • • •
	119 12	silber / silver gold / gold bronze / bronze ROH / raw W	„Primo“ Alu-Fliesenprofil, Innenhöhe 12,5 mm „Primo“ alu-profile for tiles - inner-height 12,5 mm S G B R W E M	10 10 10 10 10 10 10			• • • • • • •
	119 15	silber / silver gold / gold bronze / bronze ROH / raw	„Primo“ Alu-Fliesenprofil, Innenhöhe 15 mm „Primo“ alu-profile for tiles - inner-height 15 mm S G B R E M	10 10 10 10 10 10			• • • • • •
	119 18	silber / silver gold / gold bronze / bronze ROH / raw	„Primo“ Alu-Fliesenprofil, Innenhöhe 18 mm „Primo“ alu-profile for tiles - inner-height 18 mm S G B R	10 10 10 10			• • • •
	119 20	silber / silver gold / gold bronze / bronze ROH / raw	„Primo“ Alu-Fliesenprofil, Innenhöhe 20 mm „Primo“ alu-profile for tiles - inner-height 20 mm S G B R	10 10 10 10			• • • •
	119 22	silber / silver ROH / raw	„Primo“ Alu-Fliesenprofil, Innenhöhe 22,5 mm „Primo“ alu-profile for tiles - inner height 22,5 mm S R E	10 10 10			• • •

*Bestellware - keine Lagerware / non stock items

Unverbindlich empfohlene Verkaufspreise inkl. Ust. gültig ab 10/2014

„FLIP“ - Serie QUADRA - FLIESENABSCHLUSSPROFILE

in Aluminium und Edelstahl

„FLIP“ - type QUADRA - END PROFILES FOR CERAMIC TILES

in aluminium and stainless steel

Für waagrechte oder senkrechte Montage
For vertical or horizontal use

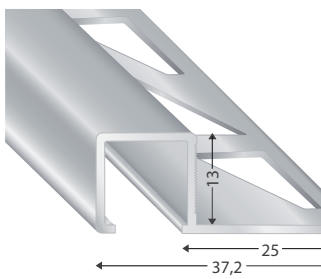
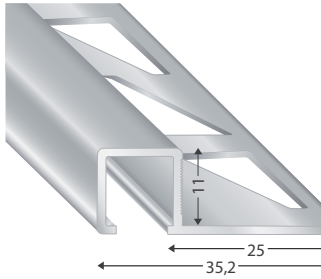
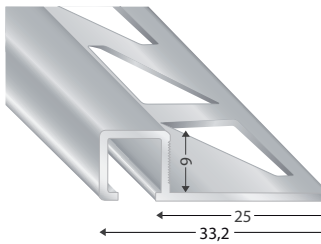
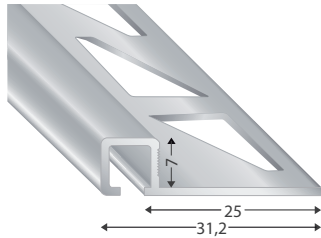

Artikel-Nr. article-no.	Farbe colour	Beschreibung description	VE unit	Preis/lfm price/lfm 250 cm	Preis/lfm price/lfm 300 cm
217 7	silber / silver	„Quadra“ Aluminium-Fliesenprofil, Innenhöhe 7 mm „Quadra“ synthetic-profile for ceramic - inner height 7 mm	10		•
	ROH / raw		10		
	weiss / white		10		
121 C 8 E	E	Innenhöhe 8 mm / inner height 8 mm	10	•	
217 9	silber / silver	„Quadra“ Aluminium-Fliesenprofil, Innenhöhe 9 mm „Quadra“ synthetic-profile for ceramic - inner height 9 mm	10		•
	ROH / raw		10		
	weiss / white		10		
121 C 9 E	E	Innenhöhe 9 mm / inner height 9 mm	10	•	
217 11	silber / silver	„Quadra“ Aluminium-Fliesenprofil, Innenhöhe 11 mm „Quadra“ synthetic-profile for ceramic - inner height 11 mm	10		•
	ROH / raw		10		
	weiss / white		10		
121 C 10 E	E	Innenhöhe 10 mm / inner height 10 mm	10	•	
121 C 11 E	E	Innenhöhe 11 mm / inner height 11 mm	10	•	
217 13	silber / silver	„Quadra“ Aluminium-Fliesenprofil, Innenhöhe 7 mm „Quadra“ synthetic-profile for ceramic - inner height 7 mm	10		•
	ROH / raw		10		
	weiss / white		10		
121 C 12 E	E	Innenhöhe 12 mm / inner height 12 mm	10	•	

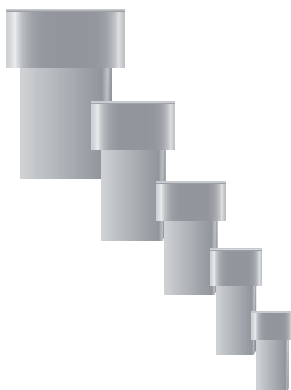

Artikel-Nr. article-no.	Farbe colour	Beschreibung description	VE unit	Preis/Stück price/piece
217 E 7	silber / silver	„Quadra“ Alu-Endstücke für Außenecken „Quadra“ alu-endcaps for outcorners	10	in Vorbereitung in preparation
217 E 9	silber / silver		10	
217 E 11	silber / silver		10	
217 E 13	silber / silver		10	
1121 C 8	E		10	•
1121 C 9	E		10	•
1121 C 10	E		10	•
1121 C 11	E		10	•
1121 C 12	E		10	•

„FLIP“ - Serie DUE und UNO - FLIESENPROFILE in Aluminium

Treppenkanten und seitliche Abschlusskante

„FLIP“ - type DUE and UNO - PROFILES FOR CERAMIC TILES in aluminium

Stair nosings and lateral edging

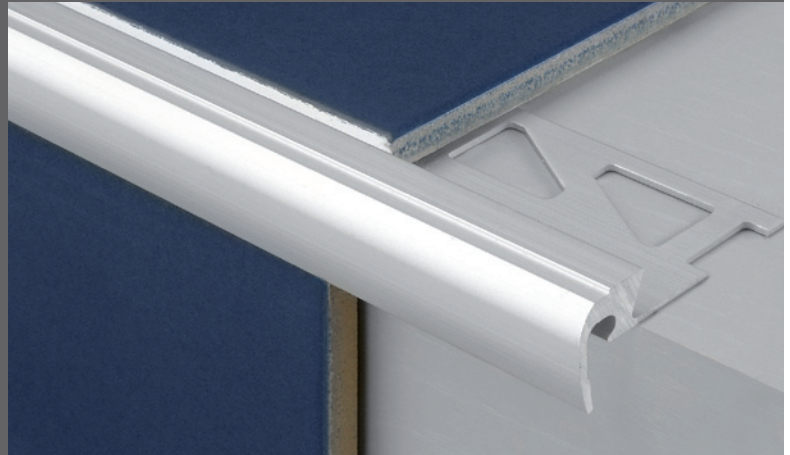

	Artikel-Nr. article-no.	Farbe colour	Beschreibung description	VE unit	Preis/lfm price/lfm 270 cm	Preis/lfm price/lfm 300 cm
	121 8	silber / silver gold / gold	Fliesentreppenkante „UNO“ ohne Einlagestreifen Artikel 27 E, Innenhöhe 8 mm Stair nosings „UNO“ without insert strip, inner-height 8 mm	10 10	• •	•
	27 E		Einlagestreifen 27 E siehe Seite 88 insert strip 27 E see page 88			
	121 10	silber / silver gold / gold	Fliesentreppenkante „UNO“ ohne Einlagestreifen Artikel 27 E, Innenhöhe 10 mm Stair nosings „UNO“ without insert strip, inner-height 10 mm	10 10	• •	•
			Einlagestreifen 27 E siehe Seite 88 insert strip 27 E see page 88			
	121 A 8	silber / silver gold / gold bronze / bronze	Fliesentreppenkante „DUE“, Innenhöhe 8 mm Stair nosings „DUE“, inner-height 8 mm	10 10 10	• • •	•
			seitlicher Abschluss für 121 A 8 UNO lateral edging for 121 A 8 UNO ohne Einlagestreifen 27 E / without insert strip 27 E			
	121 A 10	silber / silver gold / gold bronze / bronze	Fliesentreppenkante „DUE“, Innenhöhe 10 mm Stair nosings „DUE“, inner-height 10 mm	10 10 10	• • •	•
			seitlicher Abschluss für 121 A 10 UNO lateral edging for 121 A 10 UNO ohne Einlagestreifen 27 E / without insert strip 27 E			

„FLIP“ - Serie STAIR und FINALE - FLIESENPROFILE in Aluminium

Treppenkanten und Ausgleichsprofile

„FLIP“ - type STAIR and FINALE - PROFILES FOR CERAMIC TILES in aluminium

Stair nosings and adapting profiles



	Artikel-Nr. article-no.	Farbe colour	Beschreibung description	VE unit	Preis/lfm price/lfm 270 cm	Preis/lfm price/lfm 300 cm	
	121 B 10	silber / silver	Fliesentreppenkante „STAIR“, Innenhöhe 10 mm Stair nosings, „STAIR“, inner-height 10 mm	10		•	
		gold / gold		10	•	•	
		121 B 12	silber / silver	Fliesentreppenkante „STAIR“, Innenhöhe 12 mm Stair nosings, „STAIR“, inner-height 12 mm	10	•	•
			gold / gold		10	•	
	1340 8	silber / silver	Fliesenschrägprofil „FINALE“, Innenhöhe 8 mm Level adapting profile „FINALE“, inner-height 8 mm	10	•	•	
		gold / gold		10	•		
	1340 10	silber / silver	Fliesenschrägprofil „FINALE“, Innenhöhe 10 mm Level adapting profile „FINALE“, inner-height 10 mm	10		•	
		gold / gold		10	•		
	1340 12	silber / silver	Fliesenschrägprofil „FINALE“, Innenhöhe 12 mm Level adapting profile „FINALE“, inner-height 12 mm	10	•	•	
		gold / gold		10	•		
	1340 3 S 3	silber / silver	Ausgleichsprofil für 3 mm Level adapting profile for 3 mm	10		•	
	1340 4 S 3	silber / silver	Ausgleichsprofil für 4 mm Level adapting profile for 4 mm	10		•	
	1340 5,5 S 3	silber / silver	Ausgleichsprofil für 5,5 mm Level adapting profile for 5,5 mm	10		•	

NEU / NEW

„FLIP“ - Serie DOPPIO - FLIESENPROFILE in Aluminium

Mauerkanten

„FLIP“ - type DOPPIO - PROFILES FOR CERAMIC TILES in aluminium

Wall corners

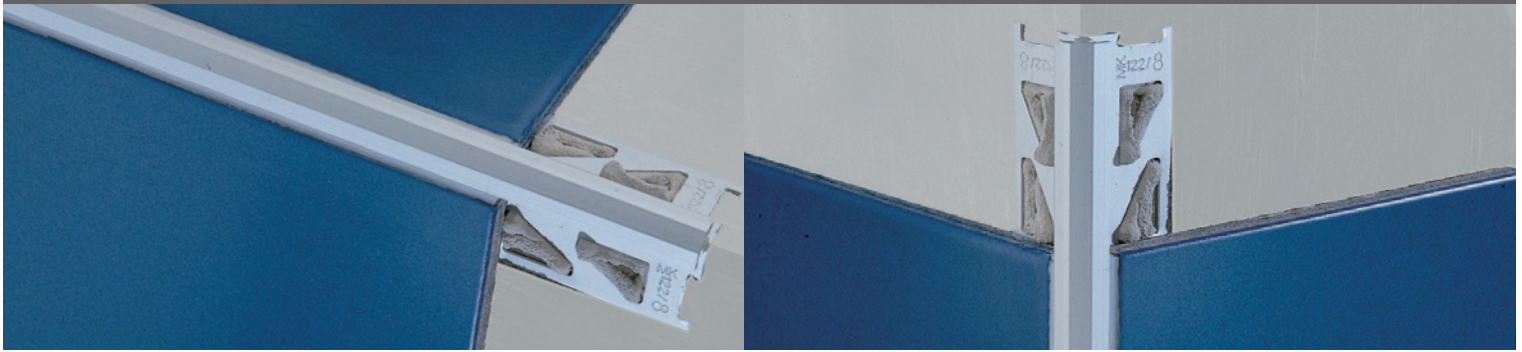

	Artikel-Nr. article-no.	Farbe colour	Beschreibung description	VE unit	Preis/lfm price/lfm 270 cm	Preis/lfm price/lfm 300 cm
	122 6	silber / silver	Mauerkantenprofil „DOPPIO“, Innenhöhe 6 mm Wall corner profile „DOPPIO“, inner-height 6 mm	10		•
		gold / gold		10	•	
		bronze / bronze		10	•	
		W		10	•	•
	122 8	silber / silver	Mauerkantenprofil „DOPPIO“, Innenhöhe 8 mm Wall corner profile „DOPPIO“, inner-height 8 mm	10		•
		gold / gold		10		•
		bronze / bronze		10	•	
		W		10	•	•
	122 11	silber / silver	Mauerkantenprofil „DOPPIO“, Innenhöhe 11 mm Wall corner profile „DOPPIO“, inner-height 11 mm	10		•
		gold / gold		10	•	•
		bronze / bronze		10	•	
		W		10	•	•

FLIESENPROFILE „STEP“ und DEKOPROFILE in Aluminium

Treppenkanten und Dehnfugenprofil

PROFILES FOR CERAMIC TILES „STEP“ and Decoprofiles in aluminium

Stair nosings and expansion joints

	Artikel-Nr. article-no.	Farbe colour	Beschreibung description	VE unit	Preis/lfm price/lfm 300 cm	Preis/Stange price/unit 300 cm
	216 9	silber / silver	Treppenkanten „STEP“, Innenhöhe 9 mm Stair-nosings „STEP“, inner-height 9 mm	10		•
	216 11	silber / silver	Treppenkanten „STEP“, Innenhöhe 11 mm Stair-nosings „STEP“, inner-height 11 mm	10		•
	216 13	silber / silver	Treppenkanten „STEP“, Innenhöhe 13 mm Stair-nosings „STEP“, inner-height 13 mm	10		•
	226 20	silber / silver	Dekoprofil - Breite 13 / 20 mm Deco profile - width 13 / 20 mm	10	•	
	226 30	silber / silver	Dekoprofil - Breite 23 / 30 mm Deco profile - width 23 / 30 mm	10	•	

„FLIP“ - Serie COMPRESSO - FLIESENPROFILE in Hart- und Weich PVC,
Alu roh und Edelstahl
Dehnfugenprofil

„FLIP“ - type COMPRESSO - PROFILES FOR CERAMIC TILES in rigid-
and soft PVC, alu raw and stainless steel
Expansion joints

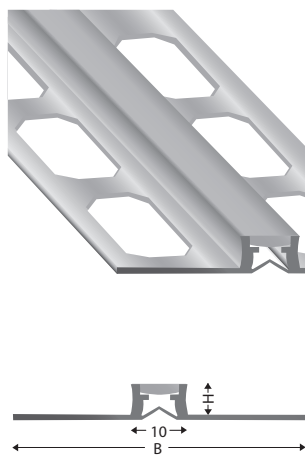
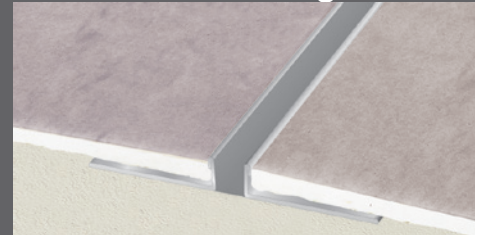

Artikel-Nr. article-no.	Farbe colour	Beschreibung description	VE unit	Preis/lfm price/lfm 270 cm
Dehnfugenprofil in KUNSTSTOFF <i>Expansion joints in SYNTHETIC</i>				
137 CA 6	grau / grey	Belaghöhe 6 mm / schwarz mit grauer Einlage <i>height of flooring 6 mm / black with gray insert</i>	10	•
137 CA 8	grau / grey	Belaghöhe 8 mm / schwarz mit grauer Einlage <i>height of flooring 8 mm / black with gray insert</i>	10	•
137 CA 10	grau / grey	Belaghöhe 10 mm / schwarz mit grauer Einlage <i>height of flooring 10 mm / black with gray insert</i>	10	•
137 CA 12	grau / grey	Belaghöhe 12 mm / schwarz mit grauer Einlage <i>height of flooring 12 mm / black with gray insert</i>	10	•
137 CA 15	grau / grey	Belaghöhe 15 mm / schwarz mit grauer Einlage <i>height of flooring 15 mm / black with gray insert</i>	10	•
137 CA 20	grau / grey	Belaghöhe 20 mm / schwarz mit grauer Einlage <i>height of flooring 20 mm / black with gray insert</i>	10	•

NEU / NEW

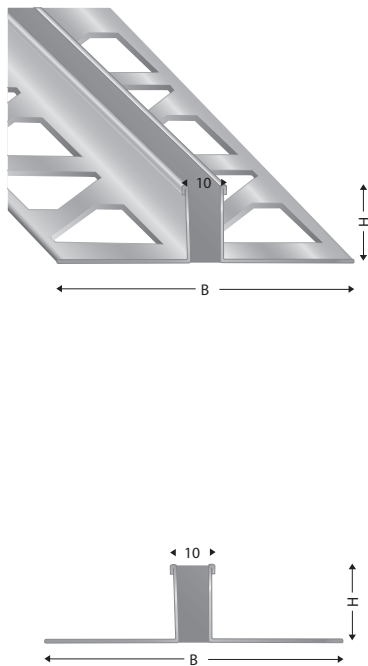

Artikel-Nr. article-no.	Farbe colour	Beschreibung description	VE unit	Preis/Stange price/unit 250 cm	Preis/Stange price/unit 300 cm
Dehnfugenprofil in ALUMINIUM oder EDELSTAHL <i>Expansion joints in ALUMINIUM or STAINLESS STEEL</i>					
DF119 3	roh / raw Edelstahl / stainless steel	Belaghöhe 3 mm / mit grauer Einlage <i>height of flooring 3 mm / with gray insert</i>	R	10	•
			E	10	
DF119 4,5	roh / raw Edelstahl / stainless steel	Belaghöhe 4,5 mm / mit grauer Einlage <i>height of flooring 4,5 mm / with gray insert</i>	R	10	•
			E	10	
DF119 6	roh / raw Edelstahl / stainless steel	Belaghöhe 6 mm / mit grauer Einlage <i>height of flooring 6 mm / with gray insert</i>	R	10	•
			E	10	
DF119 8	roh / raw Edelstahl / stainless steel	Belaghöhe 8 mm / mit grauer Einlage <i>height of flooring 8 mm / with gray insert</i>	R	10	•
			E	10	
DF119 10	roh / raw Edelstahl / stainless steel	Belaghöhe 10 mm / mit grauer Einlage <i>height of flooring 10 mm / with gray insert</i>	R	10	•
			E	10	
DF119 12,5	roh / raw Edelstahl / stainless steel	Belaghöhe 12,5 mm / mit grauer Einlage <i>height of flooring 12,5 mm / with gray insert</i>	R	10	•
			E	10	
DF119 15	roh / raw Edelstahl / stainless steel	Belaghöhe 15 mm / mit grauer Einlage <i>height of flooring 15 mm / with gray insert</i>	R	10	•
			E	10	
DF119 18	roh / raw Edelstahl / stainless steel	Belaghöhe 18 mm / mit grauer Einlage <i>height of flooring 18 mm / with gray insert</i>	R	10	•
			E	10	
DF119 20	roh / raw Edelstahl / stainless steel	Belaghöhe 20 mm / mit grauer Einlage <i>height of flooring 20 mm / with gray insert</i>	R	10	•
			E	10	

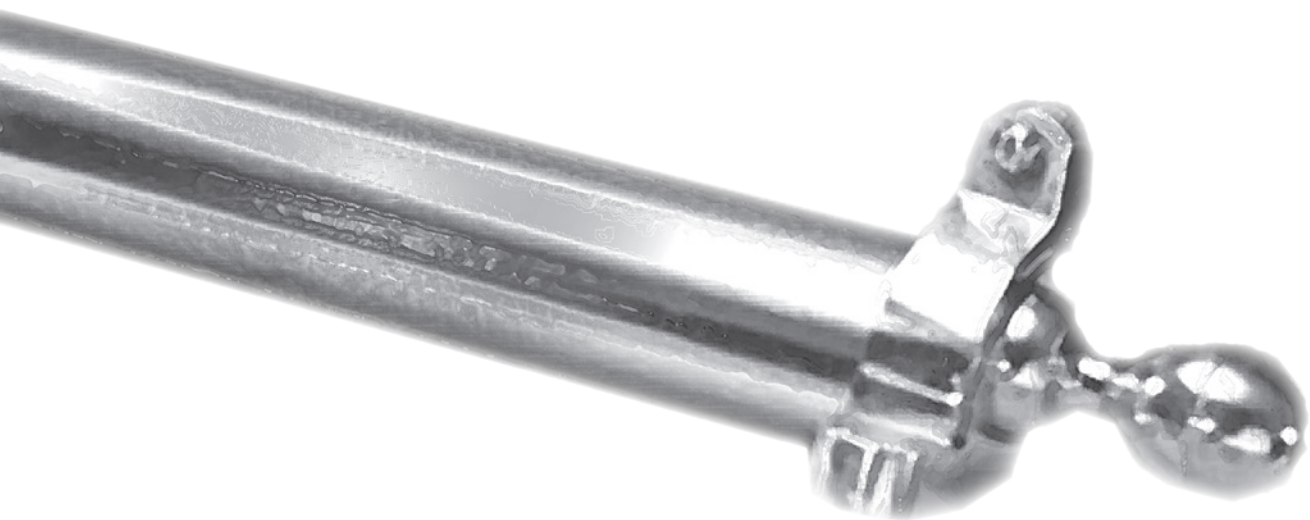

TREPPENSTANGEN

TREPPENSTANGEN *STAIR RODS*



TREPPENSTANGEN und ZUBEHÖR in Messing

Stangenlänge 5 lfm

STAIR-RODS and FITTINGS in brass

Standard length 5 lfm

ME = Stahlrohr nahtlos Messing ummantelt
 ME = brass cased steel tube
 MS = Reinmessing
 MS = brass

FARBEN / COLOURS

01 poliert / polished
 02 vernickelt glänzend / barrelled nickel
 21 vernickelt poliert glänzend / polished nickel
 22 MS verchromt / chromed
 23 MS poliert lackiert / polished brass
 29 MS nickel matt / nickel matt

Rohrzuschnitte +20%
Cut service +20%

Reinmessing = MS



Stahlrohr nahtlos Messing ummantelt = ME



Dreikantröhr Messing ummantelt = ME



Artikel-Nr. article-no.	Ø (mm) Ø (mm)	Wandstärke thickness	Beschreibung description	VE/m VE/m	Preis/lfm price/lfm
209	9	0,5	MS Rohr poliert / polished tube	5	•
2016 lackiert	16	0,5	MS Rohr poliert lackiert / polished tube	5	•
516	16	0,5	MS Rohr verchromt / chromed tube	5	•
800 16 29	16	-	MS Rohr vernickelt matt / satin nickel	5	•
13	13	-	ME Rohr glänzend / polished tube	5	•
513	13	-	ME Rohr verchromt / chromed tube	5	•
160 MS	16	-	ME Rohr glänzend / polished tube	5	•
16	16 x 16	-	ME Dreikant Rohr glänzend / triangular brass cased steel tube polished	5	•
260	16 x 16	-	ME Dreikant Rohr verchromt triangular brass cased steel tube chromed	5	•

TREPPENSTANGENÖSEN und KLOBEN / STAIR EYES and BRACKETS

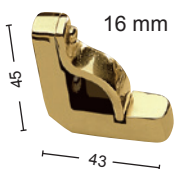
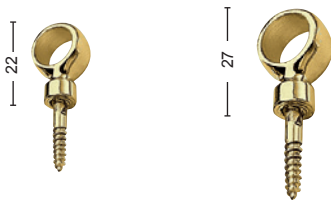

Artikel-Nr. article-no.	Ø (mm) Ø (mm)	Oberfläche material	Beschreibung description	VE VE	Preis/Stück price/piece
2101 09 01	9	MS poliert / brass polished	MS Treppenstangenöse / stair eye	1	•
2101 09 02	9	MS vernickelt glänzend / barrelled nickel	MS Treppenstangenöse / stair eye	1	•
2101 13 01	13	MS poliert / polished	MS Treppenstangenöse / stair eye	1	•
2101 13 22	13	MS verchromt / chromed	MS Treppenstangenöse / stair eye	1	•
2106 13 23	13	MS poliert lackiert polished brass	MS Treppenstangenkloben / brackets geschlossen / closed	1	•
2106 13 22	13	MS verchromt brass chromed	MS Treppenstangenkloben / brackets geschlossen / closed	1	•
2109 16 22	16 Δ16x16	MS verchromt brass chromed	MS Treppenstangenkloben / brackets geschlossen f. Rund-u. Dreikantröhr closed for round and triangular tube	1	•
2109 16 23	16 Δ16x16	MS poliert lackiert polished brass	MS Treppenstangenkloben / brackets geschlossen f. Rund-u. Dreikantröhr closed for round and triangular tube	1	•
2109 16 29	16 Δ16x16	MS nickel matt nickel matt	MS Treppenstangenkloben / brackets geschlossen f. Rundrohr closed for round tube	1	•

TREPPENSTANGEN KLOBEN und ZUBEHÖR

in Messing

STAIR-BRACKETS and FITTINGS

in brass

ME = Stahlrohr nahtlos Messing ummantelt

ME = brass cased steel tube

MS = Reinmessing

MS = brass

FARBEN / COLOURS

01 blank gerollt

20 geschliffen poliert

21 vernickelt poliert / polished nickel

22 verchromt / chromed

23 poliert lackiert / polished brass

29 vernickelt / barrelled nickel

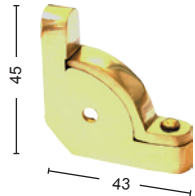

Artikel-Nr.Ø (mm) article-no.Ø (mm)	Ø (mm) Ø (mm)	Oberfläche material	Beschreibung description	VE VE	Preis/Stück price/unit
21091 16 21	16 Δ16x16	MS vernickelt glänzend brass polished nickel	MS Treppenstangenkloben für Rund- und Dreikantrohr geschlossen mit seitlicher Bohrung für Endknöpfe MS brackets closed for round and triangular cased steel - with lateral hole for finials	1	•
21091 16 23	16 Δ16x16	MS poliert lackiert brass polished brass für Endknöpfe	MS Treppenstangenkloben für Rund- und Dreikantrohr geschlossen mit seitlicher Bohrung MS brackets closed for round and triangular cased steel - with lateral hole for finials	1	•
A					
21231 13 22	13	MS verchromt brass chromed	MS Treppenstangenkloben mit fest verschraubter Befestigungslasche - seitlich offen MS brackets - latch fastened with screws, one side open	1	•
21231 13 23	13	MS poliert lackiert polished brass		1	•
21231 16 23	16	MS poliert lackiert polished brass		1	•
B					
21232 16 23	16	MS poliert lackiert polished brass	MS Treppenstangenkloben mit fest verschraubter Befestigungslasche - seitlich geschlossen MS brackets - latch fastened with screws one side closed	1	•
C					
212321 16 23	16	MS poliert lackiert brass chromed	MS Treppenstangenkloben mit fest verschraubter Befestigungslasche - seitlich geschlossen mit seitlicher Bohrung für Endknöpfe MS brackets - latch fastened with screws with hole for fixing finials one side closed with hole for finials	1	•

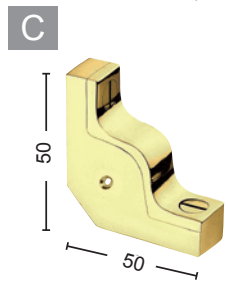
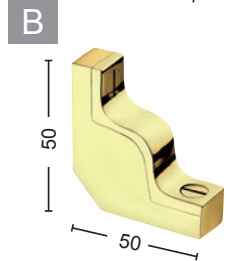
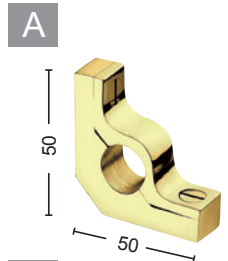

TREPPENSTANGEN-SICHERUNG / STAIR ROD GRIP



630 20 13	13	MS poliert polished brass	MS Treppenstangen-Sicherung verhindert Verrutschen und Klappern MS stair rod grip prevents rod sliding or rattling	1	•
-----------	----	------------------------------	---	---	---

ENDKNÖPFE ZU TREPPENSTANGEN / FINIALS for STAIR ROD

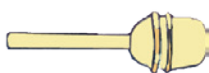

620 09 20	9	MS poliert brass polished	mit Feder / with fixing clips	1	•
620 13 20	13	MS poliert brass polished	mit Feder / with fixing clips	1	•
620 13 21	13	MS vernickelt brass nickel	mit Feder / with fixing clips	1	•

ENDKNÖPFE zu TREPPENSTANGEN

in Messing

FINIALS for STAIR ROD

in brass

ME = Stahlrohr nahtlos Messing ummantelt
 ME = brass cased steel tube
 MS = Reinmessing
 MS = brass

FARBEN / COLOURS

01 blank gerollt
 20 geschliffen poliert
 21 vernickelt poliert / polished nickel
 22 verchromt / chromed
 23 poliert lackiert / polished brass
 29 vernickelt / barrelled nickel

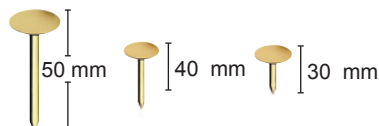

Artikel-Nr. article-no.	Farbe colour	Ø (mm) Ø (mm)	Oberfläche material	Beschreibung description	VE VE	Preis/Stück price/piece
210901	23	16	MS poliert lackiert polished brass	ohne Fixiergummi / without rubber plug	1	•
2109011	23	16	MS poliert lackiert polished brass	mit Fixiergummi / with rubber plug	1	•
2102	22	13+16	MS verchromt brass chromed	ohne Fixiergummi / without rubber plug	1	•
2102	23	13+16	MS poliert lackiert polished brass	ohne Fixiergummi / without rubber plug	1	•
21021	22	13+16	MS verchromt brass chromed	mit Fixiergummi / with rubber plug	1	•
21021	23	13+16	MS poliert lackiert polished brass	mit Fixiergummi / with rubber plug	1	•
2109081	23	16	MS poliert lackiert polished brass	mit Fixiergummi / with rubber plug	1	•
25101	01	30	MS Teppichnagel vermessingt carpet nail brassed plated	Länge / length: 30 mm	1	•
25102	01	40	MS Teppichnagel vermessingt carpet nail brassed plated	Länge / length: 40 mm	1	•
25103	01	50	MS Teppichnagel vermessingt carpet nail brassed plated VE = 100 Stück	Länge / length: 50 mm	1	•

ZUBEHÖR

ACCESSORIES

Für nähere Informationen fordern Sie unseren ZUBEHÖRKATALOG an!
For further information please ask for our accessory catalogue!





ZUBEHÖR und WERKZEUGE

ZUBEHÖR & WERKZEUGE *ACCESSORIES & TOOLS*



Qualitäts **SILIKON** zum Dichten und Dämmen - **POWERGRIP®** Montagekleber - Dauerelastisch und acetatvernetzend - für außen und innen

Quality **SILICONE** for sealing and insulation - **POWERGRIP®** installation glue

Qualitäts SILIKON und ACRYL zum Dichten und Dämmen



Artikel-Nr. <i>article-no.</i>	Farbe <i>colour</i>	Beschreibung <i>description</i>	VE <i>unit</i>	Preis/Stück <i>price/piece</i>
S 201 grau	manhattan / manhattan	310 ml	12 Stk.	•
S 201 weiss	weiss / white	310 ml	20 Stk.	•
S 201 transp.	transparent / transparent	310 ml	20 Stk.	•
ACRYL D	weiss / white	310 ml	20 Stk.	•

Anwendungsbereich:

für Industrie, Handwerk und Bau. Geeignet für wetterbeanspruchte Dehnungsfugen im Außenbereich und für den Innenausbau. für Verfugungen und Versiegelungen im Glas- und Fensterbau, für Fugen in der Küche und im Sanitärbereich, für Industrieverglasung, Fassadenbau, Bauteile, etc..

Verarbeitung:

Die Haftflächen müssen sauber, trocken, trennmittelfrei und tragfähig sein. Staub, Fette, Öle und lose Teile müssen entfernt werden. Grundsätzlich sollten nichtsaugende, geschlossenporige Untergründe mit GRUNDIERUNG Z und saugende, offenporige Untergründe mit GRUNDIERUNG GM vorbehandelt werden. Primer gut ablüften lassen. Fugenausfüllung und Fugennachbehandlung - beachten Sie die Verarbeitungshinweise.

Silikon SR

Is a permanently elastic silicone sealant on acetic basis used for sealing of glass, wood, aluminium, ceramics for internal and external application. It has a good resistance to chemicals, UV and various weather conditions as well as a low shrinkage at hardening.

Application: The surface must be dry, clean, hard and free of dust and grease. The edges must be taped with masking tapes. The cartridge to be cut at the top and the nozzle screwed on. The nozzle should be suitably cut for the width of the joint. Sealant to be applied and leveled with an appropriate tool/soapy water.

Verarbeitungstemperatur:

Am besten zwischen +5 °C bis +40 °C

Dichtstoffverbrauch:

Fugenbreite (mm) x Fugentiefe (mm) ergibt Verbrauch (ml) pro (m) Fuge. Diesen Wert teilt man durch den Kartuscheninhalt (310 ml) und erhält die Zahl der benötigten Kartuschen.

Application temperature:

+5°C - +40°C

The use of the material is relative to the width, depth and length of a joint (i.e. width 10 mm, depth 6 mm = approx. 5 meters of joint with one 310 ml-cartridge).

POWERGRIP®, LÖSUNGSMITTELFREIER MONTAGEKLEBER



Artikel-Nr. <i>article-no.</i>	Beschreibung <i>description</i>	VE <i>unit</i>	Preis/Stück <i>price/piece</i>
PG 4000	MS-Polymer Montagekleber / MS polymer installation glue	12	•
116100	Kart. Pistole	1	•

Anwendungsbereich:

Pastöser Dispersions-Montageklebstoff für verschiedenste Befestigungsarbeiten im Innenbereich an Boden, Wand und Decke. Für PVC-Kernsockelleisten, flachen Korksockelleisten, Profile, Dämm- und Dekorplatten, Wandpaneelen, Fliesen, PVC, Holz, Kork, u. ä. Haftet hervorragend auf einer Vielzahl von saugfähigen und nicht saugfähigen Untergründen und Materialien, z. B. auf Beton, Putz, Mauerwerk, Keramik, Stein, Holz, Kork, Hart- und Weichschaum, Kunststoffen, Beschichtungen, Alu, Stahlblech u.v. a.

Vorbereitung des Untergrundes:

Der Untergrund muß dauertrocken, sauber, fest und tragfähig sein. Die Klebeflächen sind von Staub und Trennmitteln zu reinigen. Zur Haftverbesserung und zur Staubbindung Untergründe mit geeigneter Grundierung vorstreichen.

Verarbeitung:

POWERGRIP® in die Handspritzpistole einlegen, Klebstoff mit gleichmäßigen Zügen herausdrücken und punkt- oder streifenförmig auf den Untergrund oder das Klebeteil auftragen. Der aufgetragene Klebstoff beginnt nach ca. 10 Minuten mit der Bildung einer Oberflächenhaut. Klebeflächen deshalb sofort oder vor Beginn der Hautbildung zusammenfügen und ggf. fixieren, einspannen oder verspreizen. Geklebte oder verfüllte Stellen so lange vor Wasser oder Feuchtigkeit schützen, bis der Klebstoff eine ledrige, wasserunempfindliche Haut gebildet hat. Klebstoffverunreinigungen in frischem Zustand mit Wasser entfernen.

Verbrauch:

Eine 290 ml-Kartusche reicht aus für ca. 10 lfm Streifen mit Ø ca. 5 mm.

Verarbeitungstemperatur:

Am besten zwischen +15 °C und +20 °C

Wärme- und Kältebeständigkeit:

Für Dauerbeanspruchungen zwischen -30 °C und +70 °C, kurzfristig bis +120 °C.

Ergiebigkeit pro Kartusche:

Bei strangförmigem Auftrag mit 0,5 cm. Düsendurchmesser ca. 17 lfdm. Bei punktförmigem Auftrag im Abstand von 30 cm, z.B. auf Platten, ca. 10 qm. Der Klebstoffauftrag muß sich insbesondere nach den zu überbrückenden Unebenheiten richten.

Lösungs- und Reinigungsmittel:

Verdüner

Lagerung: 12 Monate lagerfähig.

Cleaning material: thinner

Pay attention to the Technical Data Sheet. Test before use. Can be stored for 1 year.

Die FUGENMASSE für Parkett und Laminat in Kartuschen 310 ml

Parkett- und Laminatfugen Dichtungsmasse - silikonfrei, dauererlastisch, lösemittelfrei, formaldehydfrei, einkomponentig

LAMINAT FUGENMASSE



Artikel-Nr.	Beschreibung	VE	Preis/Stück
120 150 006	weiß	12	•
120 150 001	ahorn/esche/fichte	12	•
120 150 002	eiche hell	12	•
120 150 003	eiche dunkel	12	•
120 150 004	buche hell	12	•
120 150 005	buche dunkel	12	•
120 150 007	kirschbaum	12	•
120 150 008	nussbaum/eiche kerngeräuchert	12	•
120 150 009	merbau/mahagoni	12	•
120 150 010	wenge	12	•
120 150 011	anthrazit	12	•

ferax® Laminatfugenmasse ist eine hochwertige, einkomponentige Fugenmasse auf neutraler Silikonbasis.

EINSATZBEREICH:

Eignet sich hervorragend zum Verschließen von Übergangsfugen bei Laminatböden, von Fugen bei Zargen zum Boden, bei Übergängen zu Natursteinböden wie Marmor, Granit, Sandstein, Gneis, Terrazzo etc. – keine Gefahr durch das Abwandern von Weichmachern bzw. anderen Stoffen im Randbereich von Natursteinen – keine Randzonenverfärbung.
Im Innen- und Außenbereich einsetzbar.

VORTEILE:

- fungizid ausgestattet
- lösemittelfrei
- hoch elastisch
- natursteinverträglich
- weichmacherfrei
- schnelltrocknend

Spezifisches Gewicht:	ca. 1,03 g/cm
Eigenschaft:	pastös, standfest
Hautbildungszeit:	ca. 5 min. (bei +23°C und 50% RLF)
Verarbeitungstemperatur:	+5°C bis +35°C
Wärmebeständigkeit:	-50°C bis +150°C
Modul 100%:	ca. 0,7 N/mm

Lagerung: Bei kühler und trockener Lagerung mind. 18 Monate.
Lieferform: Standardkartusche mit 310 ml.

PARKETT FUGENMASSE

Artikel-Nr.	Beschreibung	VE	Preis/Stück
120 120 006	weiß	12	•
120 120 001	ahorn/esche/fichte	12	•
120 120 002	eiche hell	12	•
120 120 003	eiche dunkel	12	•
120 120 012	eiche gekalkt	12	•
120 120 004	buche hell	12	•
120 120 005	buche dunkel	12	•
120 120 007	kirschbaum	12	•
120 120 008	nussbaum/eiche kerngeräuchert	12	•
120 120 009	merbau/mahagoni	12	•
120 120 010	wenge	12	•

ferax® Parkettfugenmasse ist eine gebrauchsfertige, einkomponentige, silikonfreie und formaldehydfreie Fugenmasse auf der Basis einer hochwertigen Polyacrylat-Dispersion.

EINSATZBEREICH:

Eignet sich hervorragend zum Verschließen von Fugen bei allen Arten von Holzböden, wie z.B. Parkett, Dielen, Holzpflaster, Sockelleisten usw. sowohl vor als auch nach Versiegelung. Zum Verfugen von Sockelleisten und anderen Abschlüssen. Nur für den Innenbereich.

VORTEILE:

- silikonfrei
- lösemittelfrei
- geruchsneutral
- lange lagerfähig
- ohne Verlaufsstörungen überversiegelbar
- schleifbar
- schnelltrocknend
- temperaturbeständig: von -20°C bis +80°C

Lagerung: Vor Frost schützen. Kühl und trocken lagern. Originalgebinde sind mindestens 24 Monate lagerfähig.
Lieferform: Standardkartusche mit 310 ml.



PAFUDIMA - Top Elastic in Kartuschen 310 ml

Parkettfugen Dichtungsmasse - silikonfrei, dauerelastisch, lösemittelfrei, schnell trocknend, schalldämmend

PAFUDIMA - top elastic in cartridges 310 ml

Sealing compound for parquet - silicone-free, elastic-caulking, solvent-free, fast-drying, sound absorbing

	Artikel-Nr. article-no.	Farbe colour	Beschreibung description	VE unit	Preis/Stück price/piece
	Pafu	AH	für Ahorn, Kiefer und Esche for maple, pine, ash-tree	10	•
	Pafu	BU	für Buche, Kirsche for beech, cherry	10	•
	Pafu	EI	für Eiche for oak	10	•
	Pafu	EI DK	für Eiche dunkel for dark oak	10	•
	Pafu	MAH	für Mahagoni, Acayou for mahogany, acayou	10	•
	Pafu	MER	für Merbau, Doussie for merbau, doussie	10	•
	Pafu	WEN	für Wenge, Räuchereiche for wenge, smoked oak	10	•
	Pafu	NUSS	für Nuss, Teak for walnut, teak	10	•

SCHRAUBEN und DÜBEL

SCREWS and DOWELS

SENKKOPFEISENSCHRAUBEN mit Pozi Drive

Flat head pozi drive screws



Artikel Nr. article-no.	Maße in mm length in mm	Farbe colour	VE/BOX unit/box	Preis/BOX price/box
3015 S PZ VM Neu!	3 x 15	vermessingt / brass plated	200 Stk.	•
3015 S PZ VZ Neu!	3 x 15	verzinkt / zink plated	200 Stk.	•
3025 S PZ BR	3 x 25	brüniert / bronze	200 Stk.	•
3025 S PZ VM	3 x 25	vermessingt / brass plated	200 Stk.	•
3025 S PZ VZ	3 x 25	verzinkt / zink plated	200 Stk.	•
3025 S PZ E Neu!	3 x 25	Edelstahl / stainless steel	200 Stk.	•
3030 S PZ BR	3 x 30	brüniert / bronze	200 Stk.	•
3030 S PZ VM	3 x 30	vermessingt / brass plated	200 Stk.	•
3030 S PZ VZ	3 x 30	verzinkt / zink plated	200 Stk.	•
4050 S PZ VM Neu!	4 x 50	vermessingt / brass plated	200 Stk.	•

SENKKOPFSCHRAUBEN mit Dübel für DIY verpackt

FLAT HEAD SCREWS with dowels in packages for DIY



Artikel Nr. article-no.	Maße in mm length in mm	Farbe colour	VE/BOX unit/box	Preis/BOX price/box
3025 SB BR	3 x 25/5 x 25	brüniert / bronze	20 Stk.	•
3025 SB VM	3 x 25/5 x 25	vermessingt / brass plated	20 Stk.	•
3025 SB VZ	3 x 25/5 x 25	verzinkt / zink plated	20 Stk.	•
3040 SB VM Neu!	3 x 40/5 x 25	vermessingt / brass plated	20 Stk.	•
3040 SB VZ Neu!	3 x 40/5 x 25	verzinkt / zink plated	20 Stk.	•

DÜBEL DOWELS



Artikel Nr. article-no.	Maße in mm length in mm	Farbe colour	VE/BOX unit/box	Preis/BOX price/box
27005	5 x 25	grau / grey	200 Stk.	•
27006	6 x 30	grau / grey	100 Stk.	•

STAHLNÄGEL TEMPERED STEEL NAILS

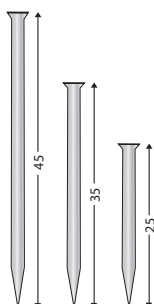

Artikel-Nr. article-no.	Beschreibung description	Masse in mm dimension in mm	VE unit	Preis/VE price/unit
151200 25	Stahlnägel, gehärtet tempered steel nails	1,5 x 25	Stulpkarton zu 1.000 Stk 1.000 pcs. per box	1.000 Stück
151200 35		1,5 x 35		•
151200 45		1,5 x 45		•
151206 25	Stahlnägel, gehärtet tempered steel nails	1,5 x 25	1 Pkg. = 20 Plastikbtl. á 100 Stk.=2.000 Stk 1 BOX =20 bags ea 100 pcs.=2.000 pcs.	2.000 Stück
151206 35		1,5 x 35		•

SCREASY SCHRAUBEN - zur perfekten Sockelleisten Montage

SCREASY SCREWS - for perfect installation



Artikel-Nr. article-no.	Beschreibung description	Masse in mm Dimension in mm	Farbe color	VE/BOX VE/box	Preis/BOX price/box
SCREASY					
38813 01	SCREASY-Kreuzschraube mit Dübel	3,5 x 35	weiss/white	500	•
38813 10		3,5 x 35	nickel	500	•
38813 30		3,5 x 35	vermessingt	500	•
38813 50		3,5 x 35	brüniert	500	•
38873 01	SCREASY-TORX-Antrieb-Schraube mit Dübel	3,5 x 35	weiss/white	500	•
38873 10		3,5 x 35	nickel	500	•
38873 30		3,5 x 35	vermessingt	500	•
38873 50		3,5 x 35	brüniert	500	•
38815 01	SCREASY-Kreuzschraube mit Dübel	3,5 x 45	weiss/white	500	•
38815 10		3,5 x 45	nickel	500	•
38815 30		3,5 x 45	vermessingt	500	•
38815 50		3,5 x 45	brüniert	500	•
38875 01	SCREASY-TORX-Antrieb-Schraube mit Dübel	3,5 x 45	weiss/white	500	•
38875 10		3,5 x 45	nickel	500	•
38875 30		3,5 x 45	vermessingt	500	•
38875 50		3,5 x 45	brüniert	500	•



Artikel-Nr. article-no.	Beschreibung description	Masse in mm Dimension in mm	Farbe color	VE/BOX VE/box	Preis/BOX price/box
SCREASY SOLO					
38675 01	SCREASY Solo-TORX-Antrieb-Schraube inkl. Bit + Bohrer	6 x 43	weiss/white	500 (Karton incl. 5/5,5 Bohrer und BIT)	•
38675 10		6 x 43	nickel	500 (Karton incl. 5/5,5 Bohrer und BIT)	•
38675 30		6 x 43	vermessingt	500 (Karton incl. 5/5,5 Bohrer und BIT)	•
38675 50		6 x 43	brüniert	500 (Karton incl. 5/5,5 Bohrer und BIT)	•



Vorbohren mit 5 mm Bohrer, keine Dübel nötig, selbstschneidender Gewindegang, 30% schnellere Montage, extremer Halt!

BLUE MARLIN CUTTER und KLINGEN - SET BLUE MARLIN CUTTER and KNIFE - SET



BLUE MARLIN Messer und Klagen BLUE MARLIN knife and blades

SETPREIS!

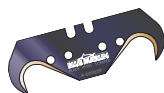
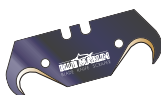
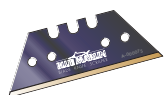

Artikel-Nr. article-no.	Beschreibung description	VE VE	Preis/Stück price/piece
----------------------------	-----------------------------	----------	----------------------------

341109900

SET HANDSCHABER & KLINGEN:

Blue Marlin PROFI Messer neutral 200x50x40 mm
mit Kunststoffköcher und 100 Stück Klagen
Blue Marlin PROFI knife with plastic holder and 100 blades

1

SET

INKLUSIVE:

Trapezklings / Straight blade 0,65 mm-Materialstärke / thickness
Hochleistungsstahl, **titanbeschichtet**
Hard material coating of titanium

30 Stück/piece

Hakenklings klein / Hook blade small 0,65 mm-Materialstärke / thickness
Hochleistungsstahl, **titanbeschichtet**
Hard material coating of titanium

50 Stück/piece

Hakenklings gross / Hook blade small 0,65 mm-Materialstärke / thickness
Hochleistungsstahl, **titanbeschichtet**
Hard material coating of titanium

20 Stück/piece



409601

Blue Marlin Messer neutral 200x50x40 mm
einfaches Wechseln der Klagen
für alle Universalklagen
*Blue Marlin knife with plastic holder
easy exchanging of blades
for all types of universal blades*

1

•

Artikel-Nr. article-no.	Beschreibung description	VE VE	Preis/BOX price/box
----------------------------	-----------------------------	----------	------------------------



361004503

Trapezklings / Straight blade 0,65 mm-Materialstärke / thickness
Hochleistungsstahl, **titanbeschichtet**
Hard material coating of titanium

100

•

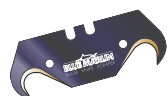

361004103

Hakenklings klein / Hook blade small 0,65 mm-Materialstärke / thickness
Hochleistungsstahl, **titanbeschichtet**
Hard material coating of titanium

100

•



361004105

Hakenklings gross / Hook blade big 0,65 mm-Materialstärke / thickness
Hochleistungsstahl, **titanbeschichtet**
Hard material coating of titanium

100

•

BLUE MARLIN HANDSCHABER und KLINGEN - SET BLUE MARLIN SCRAPER and KNIFE - SET



BLUE MARLIN Handschaber und Klingen

BLUE MARLIN scraper and knife

Artikel-Nr.
article-no.

Beschreibung
description

VE
VE

Preis/Stück
price/piece

SETPREIS!

141579900

SET HANDSCHABER & KLINGEN:

Blue Marlin Handschaber
Chromstahl mit ergonomisch
Blue Marlin scraper
High-quality of chrome steel with
ergonomic handle

100 mm

1

SET



INKLUSIVE:

Blue Marlin Schaber-Ersatzklingen 100 mm
Klinge aus gebläutem Stahl

0,7 mm-Materialstärke

20

Verpackt in blauer Aluminium Dose
Blue Marlin scraper blades
Blade made of highest-quality blued steel
in blue aluminium box

141570000

Blue Marlin Handschaber
Chromstahl mit ergonomisch
geformtem Handgriff
Blue Marlin scraper
High-quality of chrome steel with
ergonomic handle

100 mm

1

•



361004195

Blue Marlin Schaber-Ersatzklingen
Klinge aus gebläutem Stahl
Verpackt in blauer Aluminium Dose
Blue Marlin scraper blades
Blade made of highest-quality blued steel
in blue aluminium box

100 mm

0,7 mm-Materialstärke

20

•



KLINGEN BLADES

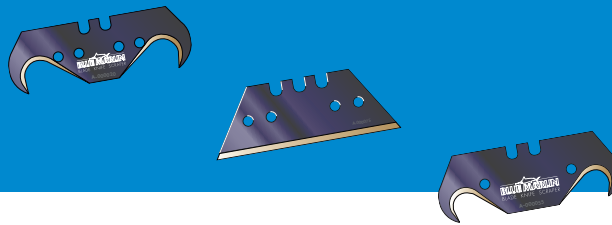

Artikel-Nr. article-no.	Beschreibung description	Masse in mm dimension in mm	VE/Dispenser VE/dispenser	Preis/Disp. price/disp.
411000	Trapezklingen Professional Professional straight utility blade Solingen-Qualität ersetzt Art. 975	60 x 18,9 x 0,63	10 x 10 = 100 Stück (Dispenser in Alubox)	•

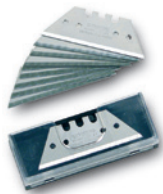

Artikel-Nr. article-no.	Beschreibung description	Masse in mm dimension in mm	VE/Dispenser VE/dispenser	Preis/Disp. price/disp.
411200	Hakenklingen Professional Professional hook-blade Solingen-Qualität ersetzt Art. 110	51 x 18,9 x 0,63	10 x 10 = 100 Stück (Dispenser in Alubox)	•



Artikel-Nr. article-no.	Beschreibung description	Masse in mm dimension in mm	VE/Dispenser VE/dispenser	Preis/Disp. price/disp.
411400	Super-Hakenklingen Professional Extra-large Professional hook blade Solingen-Qualität ersetzt Art. 105	55 x 18,9 x 0,63	10 x 10 = 100 Stück (Dispenser in Alubox)	•



KLINGEN BLADES



Artikel-Nr. article-no.	Beschreibung description	Masse in mm dimension in mm	VE/Dispenser VE/dispenser	Preis/Disp. price/disp.
311302	Abbrechklingen Professional Solingen-Qualität Snap-off blades	9 mm	20 x 10 Dispenser (Karton)	•
311402	Abbrechklingen Professional Solingen-Qualität Snap-off blades	18 mm	10 x 10 Dispenser (in Alubox)	•

KLINGEN BLADES

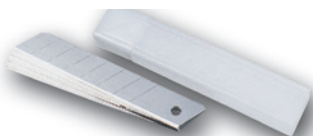

Artikel-Nr. article-no.	Beschreibung description	Masse in mm dimension in mm	VE/Blister VE/blister	Preis/Blister price/blister
311305	Abbrechklingen ECONOMY Snap-off blades ECONOMY	9 mm	50 x 10 SB Blister (Karton)	•
311405	Abbrechklingen ECONOMY Snap-off blades ECONOMY	18 mm	20 x 10 SB Blister (Karton)	•

HANDSCHABER und MESSER-SET SCRAPER and KNIFE SET



Artikel-Nr. article-no.	Beschreibung description	VE/Stück VE/piece	Preis/Stück price/piece
----------------------------	-----------------------------	----------------------	----------------------------



141610000

Blue Marlin Drehgriffschaber

Chromstahl mit ergonomisch mit bewährtem Drehverschluss, zur Befestigung der Klinge

350 x 110 x 35 mm
100 mm Klingenbreite

1

*Blue Marlin turning handle scraper
High-quality of chrome steel
with proven turning shutter to fix the blade*



341690000

Blue Marlin Abbrechklingenmesser 18 mm
für Abbrechklingen 18 mm inkl. Köcher

*Blue Marlin segmented blade knife 18 mm
Metall holder with automatic lock,
for segmented blades 18 mm incl. holster*

20

Artikel-Nr. article-no.	Beschreibung description	VE/Stück VE/piece	Preis/Stück price/piece
----------------------------	-----------------------------	----------------------	----------------------------

412010

Handschaber ROBUST / Hand-scraper ROBUST - 100m
Klingen gehärt. Spezialstahl

1

421010

Ersatzklingen für Schaber-Klingen gehärt. Spezialstahl /
Replacement blade for 412010

1



Artikel-Nr. article-no.	Beschreibung description	VE/SET VE/set	Preis/SET price/set
----------------------------	-----------------------------	------------------	------------------------

644100000

Viertelmondmesser-Set / Quarter-moon knife with pouch
mit japanischem Spezialstahl, inkl. Schweissnahtschlitten+Etui

1



CUTTER CUTTER



Artikel-Nr. article-no.	Beschreibung description	Masse in mm Dimension in mm	VE/Stück VE/piece	Preis/Stück price/piece
----------------------------	-----------------------------	--------------------------------	----------------------	----------------------------

314000

TECHNO-Cutter Professional
Gehäuse aus rostfreien Metall

9 mm

24

•

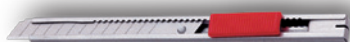

Artikel-Nr.

Beschreibung

Masse in mm

VE/Stück

Preis/Stück

314001

TECHNO-Cutter Professional
Schlagfestes Kunststoffgehäuse

9 mm

24

•



Artikel-Nr.

Beschreibung

Masse in mm

VE/Stück

Preis/Stück

314002

TECHNO-Cutter L-650
Schlagfestes Kunststoffgehäuse

18 mm

12

•



Artikel-Nr.

Beschreibung

Masse in mm

VE/Stück

Preis/Stück

314008

TECHNO-Cutter L-500
Schlagfestes Kunststoffgehäuse
3 Farben erhältlich

18mm

24

•



POLITUR, PADS, SCHLEIFBAND und SCHLEIFSCHEIBE FINISHING, PADS, ABRASIVE BELT and GRINDING DISC

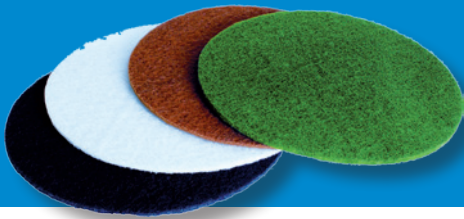

Artikel-Nr. article-no.	Beschreibung description	Farbe color	Ø Stärke in mm Ø Dimension in mm	VE VE	Preis/Stück price/piece
441220	40 SP - Superpads für Grundreinigung <i>Finishing and maintenance pads</i>	schwarz/black	40/20	5	•
441225	41 SP f.tägliche Pflege für Kunststoff und Steinböden <i>Finishing and maintenance pads</i>	grün/green	40/20	5	•
441230	42 SP Cleaner Reinigung, Pflege in einem Arbeitsgang <i>Finishing and maintenance pads</i>	rot/red	40/20	5	•
441235	43 SP f. tägliche Pflege für Kunststoff und Holzböden <i>Finishing and maintenance pads</i>	beige/beige	40/20	5	•
441240	44 SP zum Polieren, Glänzen sowie Pflegen <i>Finishing and maintenance pads</i>	weiss/white	40/20	5	•
137100000	Normal-Pads, 100 stark	weiss/white	40/10	10	•
137100200	Normal-Pads, 100 stark	beige/beige	40/10	10	•
137100600	Normal-Pads, 100 stark	grün/green	40/10	10	•
137100800	Normal-Pads, 100 stark	schwarz/black	40/10	10	•

Artikel-Nr. article-no.	Beschreibung description	Farbe color	Körnung	VE VE	Preis/Stück price/piece
221022024	Schleifband 200 x 750 mm	Zirkonkorund	24	10	•
221022036	<i>abrasive belt 200 x 750 mm</i>	Zirkonkorund	36	10	•
221022040		Zirkonkorund	40	10	•
221022060		Zirkonkorund	60	10	•
221022080		Zirkonkorund	80	10	•
221022100		Zirkonkorund	100	10	•
221022120		Zirkonkorund	120	10	•

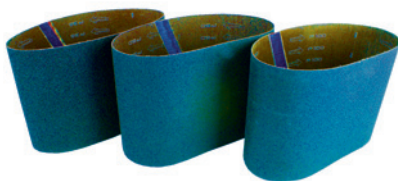

Artikel-Nr. article-no.	Beschreibung description		Ø Stärke in mm Ø Dimension in mm	VE VE	Preis/Stück price/piece
235031024	Schleifscheibe m.Klett/Loch 8	Zirkonkorund	150 mm K 24	50	•
235031036	<i>grinding disc</i>	Zirkonkorund	150 mm K 36	50	•
235031040		Zirkonkorund	150 mm K 40	50	•
235031060		Zirkonkorund	150 mm K 60	50	•
235031080		Zirkonkorund	150 mm K 80	50	•
235031100		Zirkonkorund	150 mm K 100	50	•
235031120		Zirkonkorund	150 mm K120	50	•

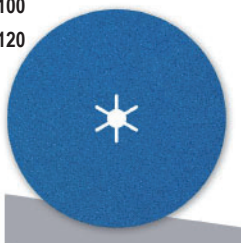

SCHLEIFBAND und SCHLEIFSCHEIBE ABRASIVE BELT and GRINDING DISC

Artikel-Nr. article-no.	Beschreibung description	Masse in mm Dimension in mm	Körnung	VE VE	Preis/Stück price/piece
73110 100	Schleifband - „Black Panther“ Schwarzes Siliziumcarbid <i>Abrasive belt „Black Panther“</i> <i>black silicium carbide</i>	200x750 mm	100	10	•
73110 120		200x750 mm	120	10	•
73110 24		200x750 mm	24	10	•
73110 36		200x750 mm	36	10	•
73110 40		200x750 mm	40	10	•
73110 50		200x750 mm	50	10	•
73110 60		200x750 mm	60	10	•
73110 80	200x750 mm	80	10	•	

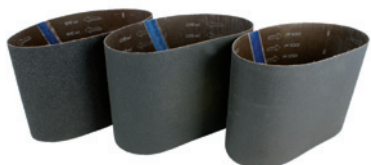

Artikel-Nr. article-no.	Beschreibung description	Ø Stärke in mm Ø Dimension in mm	Körnung	VE VE	Preis/Stück price/piece
73310 100	Schleifscheibe mit Klett/Loch 8 mm - „Black Panther“ Schwarzes Siliziumcarbid <i>grinding disc / velcro 8 mm „Black Panther“</i> <i>black silicium carbide</i>	150 mm	100	100	•
73310 120		150 mm	120	100	•
73310 150		150 mm	150	100	•
73310 36		150 mm	36	50	•
73310 40		150 mm	40	50	•
73310 50		150 mm	50	50	•
73310 60		150 mm	60	50	•
73310 80	150 mm	80	100	•	

73340 100	Schleifscheibe mit Klett/Loch 22 mm - „Black Panther“ Schwarzes Siliziumcarbid <i>grinding disc / velcro 22 mm „Black Panther“</i> <i>black silicium carbide</i>	180 mm	100	100	•
73340 120		180 mm	120	100	•
73340 150		180 mm	150	100	•
73340 36		180 mm	36	50	•
73340 40		180 mm	40	50	•
73340 50		180 mm	50	50	•
73340 60		180 mm	60	50	•
73340 80	180 mm	80	100	•	

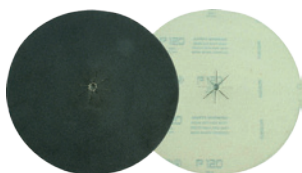

Artikel-Nr. article-no.	Beschreibung description	Masse in mm Dimension in mm	Körnung	VE VE	Preis/Stück price/piece
441410	Schleifpapier-Doppelseitig / Abrasive paper double sided Schwarzes Siliziumcarbid / <i>black silicium carbide</i>	400 mm	Korn 100	10	•
441412		400 mm	Korn 120	10	•
441416		400 mm	Korn 16	10	•
441424		400 mm	Korn 24	10	•
441440		400 mm	Korn 40	10	•
441460		400 mm	Korn 60	10	•
441480		400 mm	Korn 80	10	•

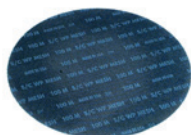

Artikel-Nr. article-no.	Beschreibung description	Masse in mm Dimension in mm	Körnung	VE Ve	Preis/Stück price/piece
----------------------------	-----------------------------	--------------------------------	---------	----------	----------------------------

441206	Schleifgitter-Gewebe / Abrasive grate	400mm	Korn 60	20	•
441208		400mm	Korn 80	20	•
441210		400mm	Korn 100	20	•
441212		400mm	Korn 120	20	•
441215		400mm	Korn 150	20	•
441218		400mm	Korn 180	20	•

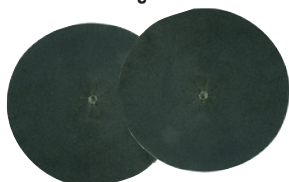

PINSEL und SPACHTELN BRUSH and PAINTER SCARPER

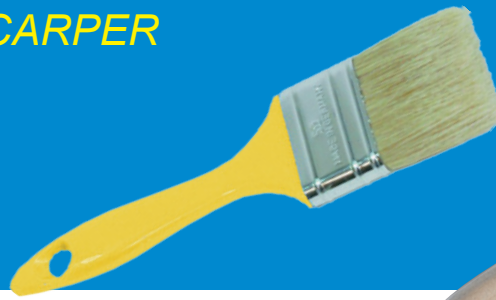

Artikel-Nr. article-no.	Beschreibung description	Masse in mm Dimension in mm	Farbe color	VE/Stück VE/piece	Preis/Stück price/piece
F8934130	Lasur-Pinsel / stain brush	Stärke 9 30 mm		12	•
F8934140	Lasur-Pinsel / stain brush	Stärke 9 40 mm		12	•
F8934150	Lasur-Pinsel / stain brush	Stärke 9 50 mm		12	•
F8934160	Lasur-Pinsel / stain brush	Stärke 9 60 mm		12	•



F8938730	Maler-Lackier-Pinsel / paint brush	30 mm		12	•
F8938740	Maler-Lackier-Pinsel / paint brush	40 mm		12	•
F8938750	Maler-Lackier-Pinsel / paint brush	50 mm		12	•
F8938760	Maler-Lackier-Pinsel / paint brush	60 mm		12	•



850150	Flachpinsel mit Chinaborste / flat brush	50 mm	gelber Kunststoffstiel / yellow plastic handle	12	•
--------	--	-------	--	----	---



Artikel-Nr. article-no.	Beschreibung description	Masse in mm Dimension in mm	VE/Stück VE/piece	Preis/Stück price/piece
100484	Malerspachtel / painter scraper	4 cm	12	•
100486	Malerspachtel / painter scraper	6 cm	12	•
100488	Malerspachtel / painter scraper	8 cm	12	•
100490	Malerspachtel / painter scraper	10 cm	12	•



Artikel-Nr. article-no.	Beschreibung description	Masse in mm Dimension in mm	VE/SET VE/set	Preis/SET price/set
101000	Japanspachtel-Satz 4-tlg. Smoothing scraper-set - 4 pcs.	50/80/105/120 mm	1	•



GLÄTTKELLE, STUKKATEURSPACHTEL und FLÄCHENRAKEL FINISHING TROWEL, MARGIN TROWEL and SURFACE COATING KNIFE



Artikel-Nr. article-no.	Beschreibung description	Masse in mm Dimension in mm	VE/Stück VE/piece	Preis/Stück price/piece
----------------------------	-----------------------------	--------------------------------	----------------------	----------------------------

101925	Flächenrakel / Surface coating knife Rostfrei, elastische Klingen	250 mm	1	•
101940	Flächenrakel / Surface coating knife Rostfrei, elastische Klinge	400 mm	1	•

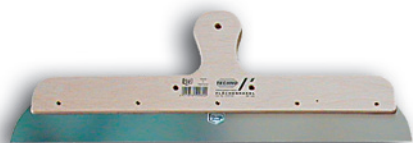

Artikel-Nr. article-no.	Beschreibung description	Masse in mm Dimension in mm	VE/Stück VE/piece	Preis/Stück price/piece
----------------------------	-----------------------------	--------------------------------	----------------------	----------------------------

107122	Glättkelle Kunststoff / Finishing trowel plastic	280x120mm	1	•
107150	Glättkelle rostfreies Edelstahlblatt / Finishing trowel stainless	280x130x0,7 mm	1	•
402165	Glättkelle aus Qualitätsstahl - 2 Komponentengriff Finishing trowel - high quality stainless	120x600 mm	1	•



Artikel-Nr. article-no.	Beschreibung description	Masse in mm Dimension in mm	VE/Stück VE/piece	Preis/Stück price/piece
----------------------------	-----------------------------	--------------------------------	----------------------	----------------------------

109606	Stukkateurspachtel, aus rostfreiem Edelstahl, Holzgriff	60 mm	10	•
109608	Margin trowel STAINLESS, wooden handle	80 mm	10	•
109610		100 mm	10	•
109612		120 mm	10	•



Artikel-Nr. article-no.	Beschreibung description	Masse in mm Dimension in mm	VE/Stück VE/piece	Preis/Stück price/piece
----------------------------	-----------------------------	--------------------------------	----------------------	----------------------------

111006	Stukkateurspachtel, aus rostfreiem Edelstahl - 2 Komponenten Softgriff	60 mm	10	•
111008	Margin trowel STAINLESS, rubber handle	80 mm	10	•
111010		100 mm	10	•
111012		120 mm	10	•



SKELETTPISTOLE, SCHABER und SCHLAGSCHNURFÄRBER CAULKING GUN, SCARPE and CHALK-LINE REEL



Artikel-Nr. article-no.	Beschreibung description	VE/Stück VE/piece	Preis/Stück price/piece
----------------------------	-----------------------------	----------------------	----------------------------

116100	PROFI-Skelettpistole - geeignet für 320 ml Standard / <i>Caulking gun / Skeleton 320 ml mit Fugenfux</i>	1	•
--------	---	---	---



Artikel-Nr. article-no.	Beschreibung description	Masse in mm Dimension in mm	VE/Stück VE/piece	Preis/Stück price/piece
----------------------------	-----------------------------	--------------------------------	----------------------	----------------------------

127800	Abscherschaber inkl. 1 Klinge / <i>Glass- and tile-scraper incl. 1 blade</i> Klingenwechsel ohne Werkzeug	100mm	1	•
--------	---	-------	---	---



Artikel-Nr. article-no.	Beschreibung description	Masse in mm Dimension in mm	VE/Blister VE/blister	Preis/Blister price/blister
----------------------------	-----------------------------	--------------------------------	--------------------------	--------------------------------

127901	Schaber-Ersatzklingen / <i>Replacement blades for scraper</i> Klingen f. Abscherschaber	100 mm	10x10	•
--------	---	--------	-------	---



Artikel-Nr. article-no.	Beschreibung description	Masse in mm Dimension in mm	VE/Stück VE/piece	Preis/Stück price/piece
----------------------------	-----------------------------	--------------------------------	----------------------	----------------------------

138600	Schlagschnurfärber , Schnurschutz-Hülse/Metallkurbel <i>Chalk-line reel</i>	30 m	3	•
--------	---	------	---	---



Artikel-Nr. article-no.	Beschreibung description	Farbe / Gewicht in gramm color / weight in gramm	VE/Stück VE/piece	Preis/Stück price/piece
----------------------------	-----------------------------	---	----------------------	----------------------------

138351	Farbpulver Schlagschnurfärber , für Art. 138600 <i>Chalk-powder</i>	rot / red, 113 g	1	•
--------	---	------------------	---	---

138352	Farbpulver Schlagschnurfärber , für Art. 138600 <i>Chalk-powder</i>	blau / blue, 113 g	1	•
--------	---	--------------------	---	---



ROLLBANDMASS, STAUBMASKE und KUPFERLEITBAND POCKET STEEL TAPE, FITTENING MASK and COPPER CONTACTIBLE RIBBON



Artikel-Nr. article-no.	Beschreibung description	Masse in m measure in m	VE/Stück VE/piece	Preis/Stück price/piece
140203	Rollbandmass Professional / Pocket steel tape knickstabiles, lackiertes Stahlband	3 m	1 x 36 Stück	•
140205	Rollbandmass Professional / Pocket steel tape knickstabiles, lackiertes Stahlband	5 m	1 x 24 Stück	•
140208	Rollbandmass Professional / Pocket steel tape knickstabiles, lackiertes Stahlband	8 m	1 x 18 Stück	•



Artikel-Nr. article-no.	Beschreibung description	VE/Karton VE/package	Preis/Stück price/piece
160800	Feinstaubmaske P1 / Filtering mask P1 Schutz bis 4-fachen MAK-Wert	1 x 20 Stück	•



Artikel-Nr. article-no.	Beschreibung description	VE/Karton VE/package	Preis/Stück price/piece
160801	Feinstaubmaske P2S / Filtering mask P2S Schutz bis 10-fachen MAK-Wert	1 x 12 Stück	•



Artikel-Nr. article-no.	Beschreibung description	VE VE	Preis/Blister price/blister
----------------------------	-----------------------------	----------	--------------------------------

441502	Kupferleitband, selbstklebend / Copper contactible ribbon, self adhesive	3 x 20 m auf Rolle	1	•
--------	--	--------------------	---	---

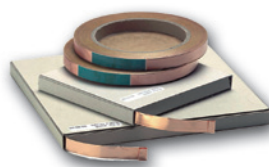

BAUFOLIE, SÄGEBOGEN, MESSER, SACK-BUTLER und KLEBSPRITZE

CONSTRUCTION FOIL, SCRAPER, KNIFE, SACK-BUTLER and GLUE SYRINGE



Artikel-Nr. article-no.	Beschreibung description	VE/Stück VE/piece	Preis/Kübel price/bucket
RT 5960 	REINIGUNGSTÜCHER / Cleaning tissues Faserverstärkte, speziell imprägnierte Tücher, Zitrusstoffe ergeben einen angenehmen Geruch	150 Stück im Kübel	•

Artikel-Nr. article-no.	Beschreibung description	Stärke thickness	VE/Rolle VE/rolls	Preis/m ² price/m ²
BAUFOL2/200 	BAUFOLIE gefaltet mit Selbstklebestreifen <i>Construction foil with adhesive tape</i>	200 µm	1 Rolle=25x2m=50m ² 1 Palette = 42 Rollen	•
Mengenrabatte auf Anfrage! / discount on request!				

Artikel-Nr. article-no.	Beschreibung description	VE/Stück VE/piece	Preis/Stück price/piece
18888 00 	SACK-BUTLER für jede Größe- Art.335000 <i>SACK-BUTLER for all size</i>	1	•



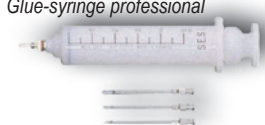

Artikel-Nr. article-no.	Beschreibung description	Stärke thickness	Masse in cm size in cm	Liter liter	VE/Rolle VE/rolls	Preis/Rolle price/rolls
MÜLLSÄCKE						
1 Rolle = 10 Säcke / 1 Karton = 20 Rollen						
MS 110	Haus- u. Gewerbemüllsack / <i>rubbish bag</i>	45 µm	70x110	110	20	•
MS 115	Gewerbemüllsack - extra reißfest	70 µm	70x110	110	20	•
MS 200	Gewerbemüllsack - extra gross	60 µm	80x120	200	20	•
MS BAU	Bauschuttsack	160 µm	45x90	45		•

Artikel-Nr. article-no.	Beschreibung description	VE VE	Preis/SET price/set
319205 	Klebespritze Professional , Nadeln in 3 versch. Stärken <i>Glue-syringe professional</i>	1	•

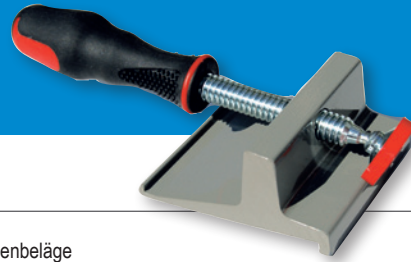
REISSKLAUE, PARKETTZUGEISEN, ABSTANDHALTER, SÄGEBOGEN und VERLEGEKEILE

CARPET-REMOVING CLAW, WANDFLOOR-SPACER, POCKET UTILITY-SAW and INSTALLATION WEDGES

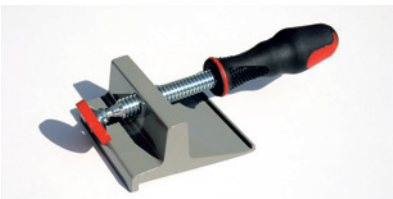
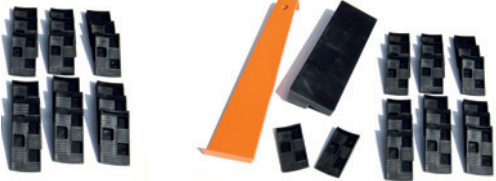

Artikel-Nr. article-no.	Beschreibung description	VE/Stück VE/piece	Preis/Stück price/piece
418700	Aluminium-Reissklaue , zum entfernen verklebter Bodenbeläge <i>Aluminium carpet-removing claw</i>	1	•
			
Artikel-Nr. article-no.	Beschreibung description	VE/Stück VE/piece	Preis/Stück price/piece
418843	Parkettzugeisen Professional , Amboss m. Schlagschutzkappe <i>Heavy-duty pulling iron</i>	1	•
			
Artikel-Nr. article-no.	Beschreibung description	VE/Stück VE/piece	Preis/Stück price/piece
436100	Wand-Abstandhalt. Professional zum Fixieren des Wandabstandes <i>Woodfloor-spacer Professional</i>	1	•
			
Artikel-Nr. article-no.	Beschreibung description	VE/Blister VE/blister	Preis/Blister price/blister
437120	Verlegekeile Set 20-teilig <i>Installation wedges</i>	1	•
437140	DIY-Verlegeset 22-teilig , Zugeisen, Schlagklotz, Keile, ... <i>DIY-Installation kit</i>	1	•
			
Artikel-Nr. article-no.	Beschreibung description	VE/Stück VE/piece	Preis/Stück price/piece
185300	Taschen-Sägebogen PUK / Pocket utility-saw PUK Sägeblatt = 147 mm	1	•
			

MUTTERSPACHEL ADHESIVE-SPREADER

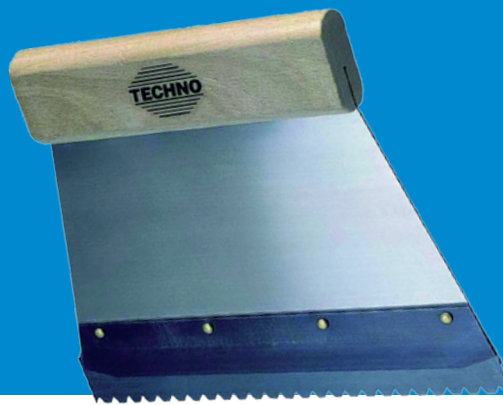

Artikel-Nr. article-no.	Beschreibung description	Masse in mm Dimension in mm	VE/Stück VE/piece	Preis/Stück price/piece
400118	Mutterspachtel inklusive auswechselbare Zahnleiste B2 <i>Adhesive-spreader professional holder</i>	180 mm	6	•
400128	Mutterspachtel inklusive auswechselbare Zahnleiste B2 <i>Adhesive-spreader professional holder</i>	280 mm	6	•
243451800	Mutterspachtel antihafbeschichtet - Teflon <i>Adhesive-spreader</i>	180 mm	4	•
243452800	Mutterspachtel antihafbeschichtet - Teflon <i>Adhesive-spreader</i>	280 mm	4	•

Zahnleisten gibt es in den Breiten 180 mm und 280 mm!
Notched blades in 180 mm and 280 mm!

A Feinzahnung

Bezeichnung:

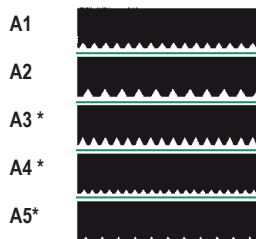

B Grob Zahnung

Bezeichnung:

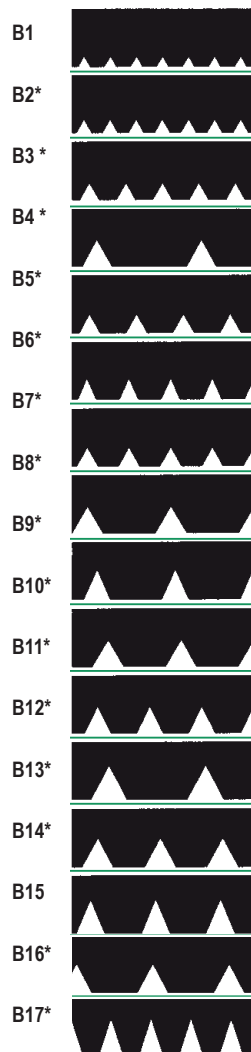

C Grob Zahnung

Bezeichnung:

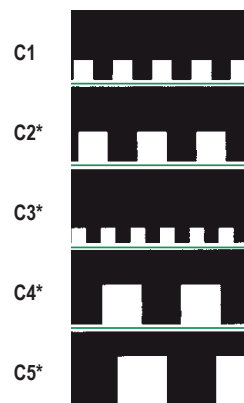

Spezialzahnung

Bezeichnung:

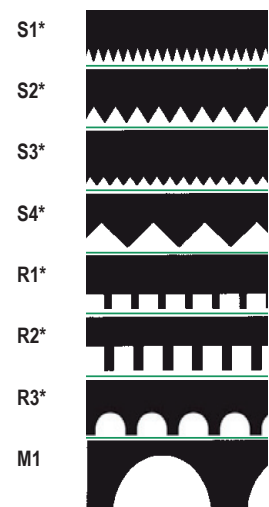

ZAHNSPACHTEL ADHESIVE-SPREADER



Artikel-Nr. article-no.	Beschreibung description	Masse in mm Dimension in mm	VE/Stück VE/piece	Preis/Stück price/piece
400017	PROFI-Zahnpachtel / <i>Adhesive-spreader professional</i> für textile Bodenbeläge / <i>for synthetic floorings</i>	180mm/B2 a=2,6 mm b=2,9 mm c=2,1 mm	6	•
400018	PROFI-Zahnpachtel / <i>Adhesive-spreader professional</i> für textile Bodenbeläge / Linoleum / <i>for synthetic floorings</i>	180mm/B1 a=2,0 mm b=2,3 mm c=2,7 mm	6	•
400019	PROFI-Zahnpachtel / <i>Adhesive-spreader professional</i> elastische-textile Bodenbeläge / <i>for elastic synthetic floorings</i>	180mm/A1 a=1,5 mm b=1,8 mm c=1,2 mm	6	•
400020	PROFI-Zahnpachtel / <i>Adhesive-spreader professional</i> elastische-textile Bodenbeläge / <i>for elastic synthetic floorings</i>	180mm/A2 a=1,6 mm b=1,8 mm c=1,3 mm	6	•
400021	PROFI-Zahnpachtel / <i>Adhesive-spreader professional</i> grobe Zahnung	180mm/B3	6	•
400022	PROFI-Zahnpachtel / <i>Adhesive-spreader professional</i> breite Zahnung	180mm/A3	6	•
400024	PROFI-Zahnpachtel / <i>Adhesive-spreader professional</i> feine Zahnung	180mm/B4	6	•
400025	PROFI-Zahnpachtel / <i>Adhesive-spreader professional</i> kastenförmige Zahnung	180mm/C1	6	•
400028	PROFI-Zahnpachtel / <i>Adhesive-spreader professional</i> für textile Bodenbeläge/Linoleum / <i>for synthetic floorings</i>	280mm/B1 a=2,0 mm b=2,3 mm c=2,7 mm	6	•
400029	PROFI-Zahnpachtel / <i>Adhesive-spreader professional</i> elastische-textile Bodenbeläge / <i>for elastic synthetic floorings</i>	280mm/A1 a=1,5 mm b=1,8 mm c=1,2 mm	6	•
400030	PROFI-Zahnpachtel / <i>Adhesive-spreader professional</i> elastische-textile Bodenbeläge / <i>for elastic synthetic floorings</i>	280mm/A2 a=1,6 mm b=1,8 mm c=1,3 mm	6	•
400031	PROFI-Zahnpachtel / <i>Adhesive-spreader professional</i> grobe Zahnung	280mm/B3	6	•
400032	PROFI-Zahnpachtel / <i>Adhesive-spreader professional</i> breite Zahnung	280mm/B4	6	•
400033	PROFI-Zahnpachtel / <i>Adhesive-spreader professional</i> kastenförmige Zahnung	280mm/C1	6	•
400037	PROFI-Zahnpachtel / <i>Adhesive-spreader professional</i> für textile Bodenbeläge / <i>for synthetic floorings</i>	280mm/B2 a=2,6 mm b=2,9 mm c=2,1 mm	6	•
101720	AUFSTREICHSPACHTEL mit Holzgriff / <i>Spreader with wooden steel</i>	20 cm	6	•
101730	AUFSTREICHSPACHTEL mit Holzgriff / <i>Spreader with wooden steel</i>	30 cm	6	•



ARBEITSKLEIDUNG, SCHUHE, KNIESCHONER und HANDSCHUHE WORKING CLOTHES, SHOES, KNEE PADS and GLOVES



Artikel-Nr. article-no.	Beschreibung description	Masse in mm dimension in mm	VE VE	Preis/Stück price/piece
971300440	Bundhose rot/schwarz / Knee breaches in red/black	Größe / size 44	1	•
971300460	Bundhose rot/schwarz / Knee breaches in red/black	Größe / size 46	1	•
971300480	Bundhose rot/schwarz / Knee breaches in red/black	Größe / size 48	1	•
971300500	Bundhose rot/schwarz / Knee breaches in red/black	Größe / size 50	1	•
971300520	Bundhose rot/schwarz / Knee breaches in red/black	Größe / size 52	1	•
971300540	Bundhose rot/schwarz / Knee breaches in red/black	Größe / size 54	1	•
971300560	Bundhose rot/schwarz / Knee breaches in red/black	Größe / size 56	1	•
971300580	Bundhose rot/schwarz / Knee breaches in red/black	Größe / size 58	1	•
971300600	Bundhose rot/schwarz / Knee breaches in red/black	Größe / size 60	1	•



Hohe Funktionalität und optimale Passform, ansprechendes Design und bequemer Schnitt

Hochverschleißfester Kniestoff KEVLAR, sowie 90 Verstärkungsstellen, Schweizer Qualitäts - Reißverschluss

Einfaches Verstellen der Bundweite innen

Eine Praktische Beintasche, ausklappbare Zusatztaschen an beiden Seiten, Köcher und Metertasche extra

65% Polyester/35 % Baumwolle

Artikel-Nr. article-no.	Beschreibung description	Masse in mm dimension in mm	VE VE	Preis/Paar price/pair
4602..	Sicherheitsschuhe / Safety shoes sportlich, trendy und sicher Stahlkappe bietet Schutz gegen fallende Gegenstände Textilverbundwerk gegen das Eindringen von spitzen Gegenständen Sohle resistent gegen Hitze	Grösse / Size 40 Grösse / Size 41 Grösse / Size 42 Grösse / Size 43 Grösse / Size 44 Grösse / Size 45 Grösse / Size 46	1 1 1 1 1 1 1	• • • • • • •



Artikel-Nr. article-no.	Beschreibung description	Masse in mm dimension in mm	VE VE	Preis/Paar price/pair
9790000	Knieschoner-Einlage in weiss Standard knee pads foam in white	L=200 B=150 Dicke 20mm	1 Paar im Plastikbeutel	•



Artikel-Nr. article-no.	Beschreibung description	Masse in mm dimension in mm	VE VE	Preis/Paar price/pair
161007	Nylon Handschuh schwarz aus 100 % Nylon Nylon gloves black	Grösse 9 size 9	12 Paar	•



TECHNO Energie Spot Lights

TECHNO energie spot lights



Die PROFI Ausführung für den Handwerker mit vielen Details:

- robustes Gehäuse
- ergonomisch geformter Tragegriff
- stabiler Standfuss, bzw. Teleskopstativ
- An/Aus - Schalter
- verstärkte Messing-Leuchtmittelfassung

Artikel-Nr.
article-no.

Beschreibung
description

VE/Stück
VE/piece

Preis/Stück
price/piece



501200

Techno-Profi-Energie-Spot-Light auf Standfuss
Professional energy spot light with feet
mit 55 Watt - 3 Meter Gummikabel

1

•



501400

Techno-Profi-Energie-Spot-Light auf Teleskopstativ
Professional energy spot light with stand
mit 55 Watt - 5 Meter Gummikabel

1

•



501402

Techno-Profi-Energie-Spot-Light auf Teleskopstativ
Double Professional engery spot light with stand
mit 2x55 Watt - 5 Meter Gummikabel

1

•



501255

Profi-Energie-Ersatzleuchte 55 Watt
Spare bulb 55 Watt

1

•



Einfaches einsetzen bzw. wechseln der Ersatzleuchte
(ohne Werkzeug) durch Drehen des Lampenrings

Robuste Energieleuchte (wird separat mitgeliefert)
mit einer E27 Fassung

LAMINAT - und PARKETTUNTERLAGEN



„SOFTFLEX®“ - AQUASTOP in Rollen

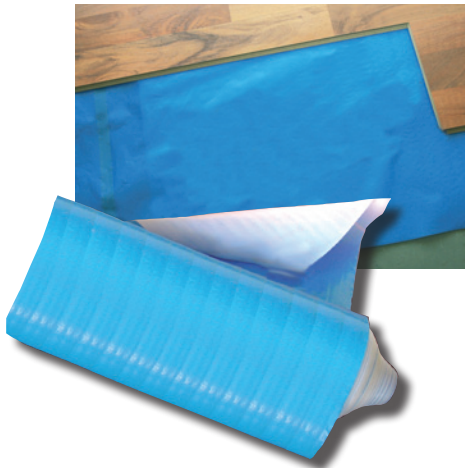

3mm stabil-elastischer FCKW-freier Polyethylenschaum



Dampfbremse durch bereits aufgeschweißte, extrafeste TYP 200 Folie bis zu max. Restfeuchtigkeit



geeignet bei Fußbodenheizung temperaturbeständig: von -30° bis + 90°



durch selbstklebende Überlappung absolut anwendungssicher und dicht



einfach und schnell zu verlegen (blaue Folie oben)



absorbiert Raumschall



nach Normung gemessen ca. 18dB dämmt Trittschall



gleicht kleine Unebenheiten aus



transportfreundlich durch geringes Gewicht und günstige Maße: 25 x 1 m = 25 m² / ca. 7 kg ca. 28 kg / m² (inkl. Folie)



entspricht der Empfehlung der EPLF (Vereinigung der Europäischen Laminat-Produzenten)



TOP Qualität zu fairem Preis

Softflex® AQUASTOP

Artikel Nr.	Farbe	Länge	Breite	Stärke	Preis/m ²
AQUA3/200	blau	25 m	1 m	3 mm/200 µ	•

Vorteile gegenüber anderen Produkten:

- keine separate Folie, da schon aufgeschweißt
- durch handliche Rollen schnell verlegt
- kein separates Klebeband, da schon vorgefertigt

„SOFTFLEX®“ - AQUAGRÜN 2 in Rollen

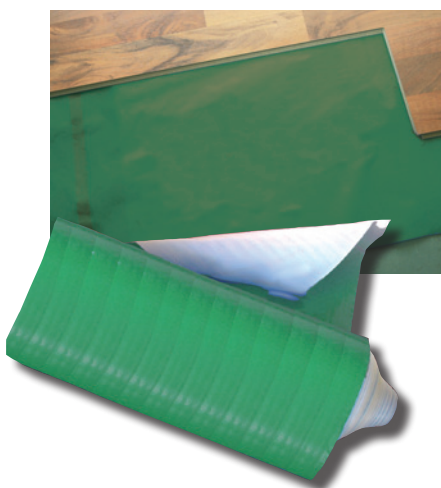

2mm stabil-elastischer FCKW-freier Polyethylen Schwertschaum 35 kg/m³



Dampfbremse durch bereits aufgeschweißte, extrafeste TYP 200 Folie bis zu max. Restfeuchtigkeit von 3%



geeignet bei Fußbodenheizung temperaturbeständig: von -30° bis + 90°



durch selbstklebende Überlappung absolut anwendungssicher und dicht



einfach und schnell zu verlegen (grüne Folie oben)



absorbiert Raumschall



nach Normung gemessen ca. 18dB dämmt Trittschall



gleicht kleine Unebenheiten aus



transportfreundlich durch geringes Gewicht und günstige Maße: 25 x 1 m = 25 m² / ca. 9,80 kg ca. 38 kg / m² (inkl. Folie)



entspricht der Empfehlung der EPLF (Vereinigung der Europäischen Laminat-Produzenten)



TOP Qualität zu fairem Preis

Softflex® AQUAGRÜN 2

Artikel Nr.	Farbe	Länge	Breite	Stärke	Preis/m ²
AQUAGRÜN 2	grün	25 m	1 m	2 mm/200 µ	•

PRÜFZERTIFIKAT der Technischen Versuchs- und Forschungsanstalt auf Anfrage!

Unverbindlich empfohlene Verkaufspreise inkl. Ust. gültig ab 10/2014

LAMINAT - und PARKETTUNTERLAGEN

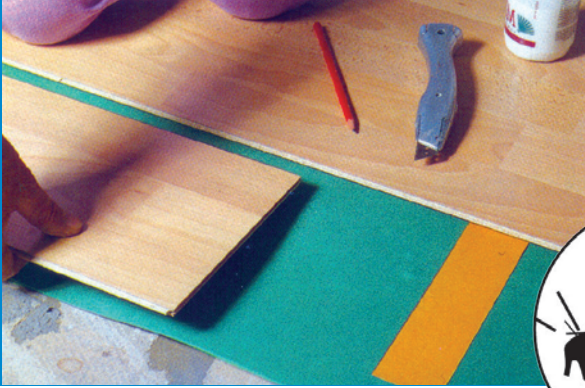

SOFTFLEX® 2

Produktname

SOFTFLEX 2

Beschreibung:

Geschlossenzelliger, physikalisch vernetzter Polyethylenschaumstoff
aquagrün
2 mm
1000
50
ca. 5,5 kg
33 kg

Farbe:

Dicke (mm):

Breite (mm):

Rollenmass (m²):

Rollengewicht:

Dichte (kg/m³):

Verlegung

Anwendungsbereiche:

Wohnen

Verlegungsart:

lose

Anwendungstechnische Daten

Trittschalverbesserungsmass (DIN 52210):

ca. 16 –18 dB

Wärmeleitfähigkeit (ISO 2581):

0,034 W/mK bei 10° Mitteltemperatur

Wärmedurchlasswiderstand (ISO 2581):

0,055 m²K/W bei 10°Mitteltemperatur

Flächenbelastung:

max. Flächenbelastung ca. 1,5 kPa (150 kg/m²)

Fußbodenheizungseignung (DIN 66095):

ja

Wasserdampfdiffusionswiderstandszahl μ

(ISO 1663, 23°, 0-85% rel. Feuchtigkeitsgefälle)

Emissionen:

keine

Umweltinformation:

Polyethylenschaumstoff hergestellt ohne FCKW;
frei von Schwermetallen, Formaldehyd. Entsorgung
über Hausmüll möglich; recyclingfähig unter definierten Voraussetzungen.

Artikel Nr.	Farbe	Länge	Breite	Stärke	Preis/m ²
SOFTFLEX 2	aquagrün	50 m	1 m	2 mm	•

SOFTFLEX® 3

Produktname

SOFTFLEX 50

Beschreibung:

Geschlossenzelliger, physikalisch vernetzter Polyethylenschaumstoff
anthrazit
3 mm
1000
50
ca. 4,80 kg
33 kg

Farbe:

Dicke (mm):

Breite (mm):

Rollenmass (m²):

Rollengewicht:

Dichte (kg/m³):

Verlegung

Anwendungsbereiche:

Objekt, Wohnen

Verlegungsart:

lose

Anwendungstechnische Daten

Trittschalverbesserungsmass (DIN 52210):

ca. 17 –18 dB

Wärmeleitfähigkeit (ISO 2581):

0,034 W/mK bei 10° Mitteltemperatur

Wärmedurchlasswiderstand (ISO 2581):

0,088 m²K/W bei 10°Mitteltemperatur

Flächenbelastung:

>6600 kg/m²

Fußbodenheizungseignung (DIN 66095):

ja

Emissionen:

keine

Reinigung:

mit üblichen Reinigungsmethoden;
geschlossenzellig, keine Wasseraufnahme

Umweltinformation:

Polyethylenschaumstoff, FCKW-frei hergestellt,
frei von Schwermetallen, Formaldehyd

Artikel Nr.	Farbe	Länge	Breite	Stärke	Preis/m ²
SOFTFLEX 10	anthrazit	10 m	1 m	3 mm	•
SOFTFLEX 50	anthrazit	50 m	1 m	3 mm	•

LAMINAT - und PARKETTUNTERLAGEN



PEP 210 P in Rollen

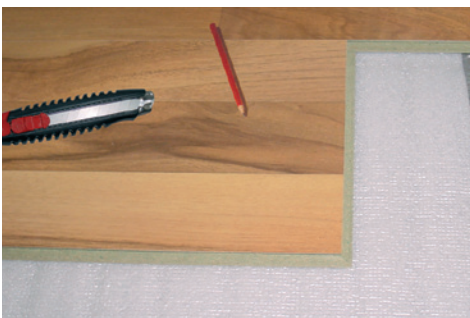

2mm weißer PE Schaum, 100cm breit mit transparenter 20µ Folie, Folienbreite 120cm, überlappend ohne Klebeband

Wärmeleitfähigkeit 0,04 W/mK

Fußbodenheizung geeignet

(-30 bis +90°C)

Dicke 2 mm in weiss

Unverrottbar, recyclebar, wasserabweisend

Verlegung: lose auf den Untergrund legen, stumpf stoßen, an Stoßstellen mittels Klebeband verkleben.

Artikel Nr.	Farbe	Gewicht/Rolle	Länge/Breite	Dicke in mm	VE	Maß/Rolle	Preis/m ²
PEP 210 P	weiss	1,5 kg	25mx100cm	2	4	25 lfm	•

Nicht verträglich mit: Kaltbitumen und Bitumen, Spachtelmasse mit Lösungsmitteln, Teerprodukten, Äther, Essigester, Benzol, Xylol, Lackverdünnung, Trichloräthylen, Tetrachlorkohlenstoff, Terpentin, Wund- und Testbenzin, Normal und Superbenzin

Verwendung: zur Trittschalldämmung, sowie Dampfbremse unter schwimmend verlegtem Fertigparkett, als Schallbremse zwischen Laminat/Parkettböden und Estrichen

STEAMBRAKE in Platten

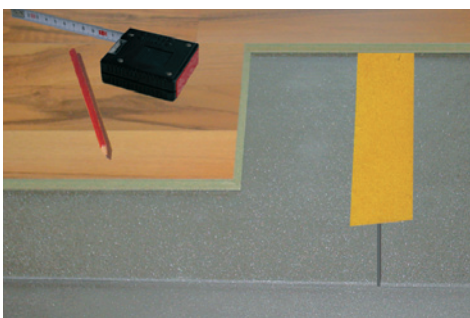

Expandiertes, extrudiertes Polystyrol mit geschlossener Zellstruktur

gute Wärmeleitfähigkeit: 0,033 W/mK

Fußbodenheizung geeignet

(-25 bis +85° C)

Dicke 3 mm in grau

Unverrottbar, recyclebar

Artikel Nr.	Farbe	Gewicht/Karton	Länge/Breite	Dicke in mm	VE	Kartoninhalt	Preis/m ²
STEAMBRAKE	grau	5,8 kg	80cmx125cm = 1m ²	3	400m ²	40m ² = 40 Stk.	•

Verträglich mit allen lösungsmittelfreien Stoffen

Verwendung: zur Trittschalldämmung, sowie Dampfbremse unter schwimmend verlegtem Fertigparkett und Laminatböden

LAMINAT - und PARKETTUNTERLAGEN

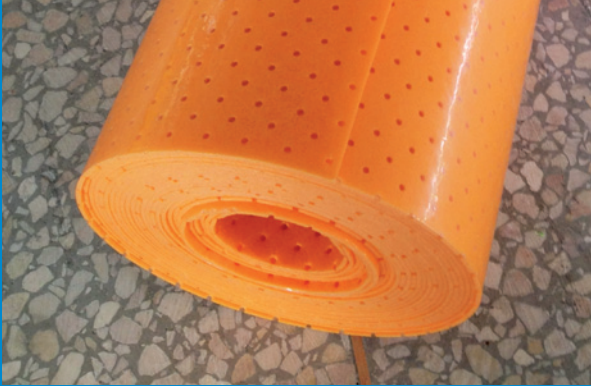

PERFORATE 1.0

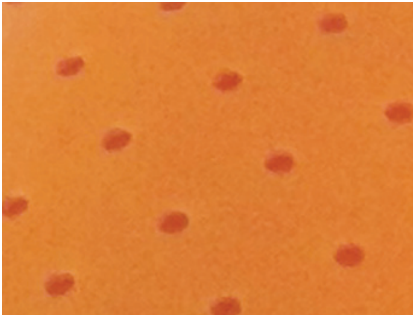

Artikel Nr.	Farbe	Gewicht/Rolle	VE	Maß/Rolle	Preis/m ²
PERFORATE	orange	1,5 kg	4	25 lfm	•

Material: Polyethylen
 Dichte: 100 kg/m³
 Stärke: 1,2 mm (inkl. Folie)
 Breite: 1 m
 Länge: 25 m
 Farbe: orange, gelocht
 Ausführung: einseitig selbsthaftend mit Schutzfolie

EIGENSCHAFTEN:

- Unterlagsmatten in schwerer Ausführung, speziell für dünne Bodenbeläge (LVT, Vinyl etc.....)
- Besonders geeignet für Bodenheizung aufgrund vollflächig verteilter Diffusionslöcher

V-PAD 1.0



Artikel Nr.	Farbe	Gewicht/Rolle	VE	Maß/Rolle	Preis/m ²
V-PAD	blau	1,5 kg	4	25 lfm	•

Material: Polyethylen
 Dichte: 100 kg/m³
 Stärke: 1,2 mm (inkl. Folie)
 Breite: 1 m
 Länge: 25 m
 Farbe: blau
 Ausführung: einseitig selbsthaftend mit Schutzfolie

EIGENSCHAFTEN:

- Unterlagsmatten in schwerer Ausführung, speziell für dünne Bodenbeläge (LVT, Vinyl etc.....)

VERKAUFSTOOLS

PROMOTION MATERIAL

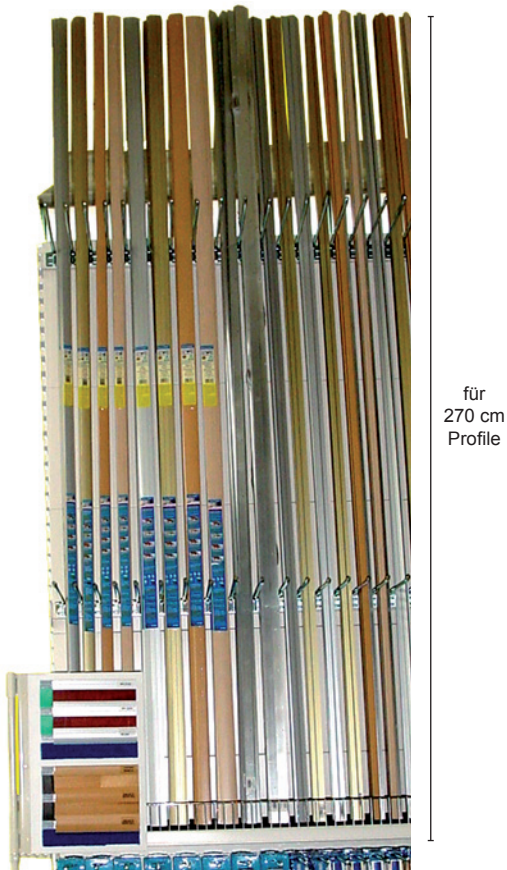

für
270 cm
Profile

MODUL 1: nur für (only for) 270 cm
Breite / width : 100 cm oder 125 cm
Höhe / height : ca. 270 cm
Tiefe / depth : ca. 60 cm
Sockel / base : ca. 20 cm

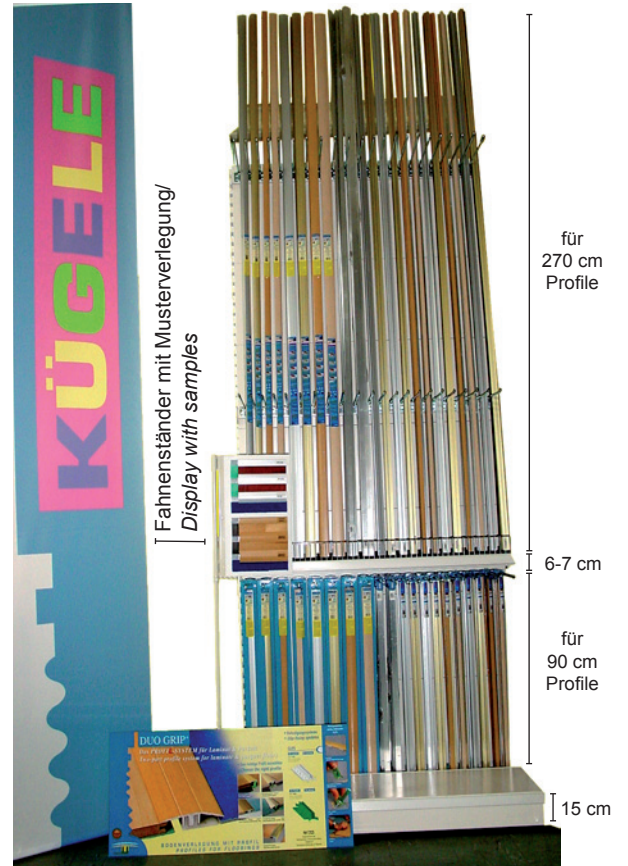

Fahnenständer mit Musterverlegung/
Display with samples

für
270 cm
Profile

6-7 cm

für
90 cm
Profile

15 cm

MODUL 2: für (for) 90 cm und (and) 270 cm
Breite / width : 100 cm oder 125 cm
Höhe / height : ca. 400 cm
Tiefe / depth : ca. 60 cm
Sockel / base : ca. 20 cm



MUSTERKOFFER mit 7 cm Mustern von Standard und Systemprofilen
Sample case with 7 cm samples of standard and system profiles



KOFFER / Sample Case
KDG mit/with DUO GRIP®
KTG mit/with TRIO GRIP®twist
DGTG mit/with DUO GRIP®
und/and TRIO GRIP®twist

VERKAUFSSTÄNDER

PROMOTION DISPLAYS



STÄNDER 3 reihig
DISPLAY 3 rows



STÄNDER 3 reihig hintereinander
DISPLAY 3 rows one behind the other



STÄNDER 3 reihig hintereinander
DISPLAY 3 rows one behind the other

KÜGELE



STÄNDER einfach 3 reihig
single DISPLAY 3 rows
Breite / width : 100 cm
Höhe / height : 182 cm
Tiefe / depth : 50 cm

