

KÜGELE



KÜGELE BUCH 2019/20
KÜGELE BOOK 2019/20



Dagmar Gross-Kügele, Eigentümerin:

„Neben dem Vollsortiment an Bodenprofilen für unterschiedlichste Beläge lagern wir auch ein großes Sortiment an Raumausstattungszubehör, welches laufend den Bedürfnissen des raumausstattenden Gewerbes angepasst wird. So haben wir in den letzten Jahren neue Produktgruppen wie Schleifmittel, Werkzeuge für den Bodenleger oder auch die besonders hochwertigen Regard-Sockelleisten in unser Sortiment integriert.“



Markus Claudius Proll, Geschäftsführer:

„Mit unseren 7 eigenen Handelsreisenden im deutschsprachigen Europa und unserem umfangreichen Sortiment für die Raumausstattung wollen wir auch in den nächsten Jahren ein starker Partner für die Gewerbebetriebe bleiben und sehen voller Optimismus in die Zukunft.“

Hinweise zu unserer Preisliste: Terms and conditions price list:

Preis:	Gültig ab 1. Jänner 2019 - Letztverbraucherpreise in EURO inkl. MwSt. Alle früheren Preise und Sondervereinbarungen werden mit diesem Termin ungültig! Unsere Preise sind auf der augenblicklichen Kostenbasis (Materialkosten etc.) erstellt. Sollte sich die Basis ändern, behalten wir uns die Verrechnung eines Teuerungszuschlages = TZ ausdrücklich vor. <i>Valid with effect from 1. January 2019. All prices are retail prices in EURO incl. VAT. These Terms and Conditions supercede all previous prices and conditions. Our prices are calculated on the current raw material and other costs. Should there be a change in raw material or other costs, we reserve the right to adjust the prices/offset a surcharge.</i>
Price:	
Händlerkonditionen:	Nach Abzug der Händlerkonditionen (-50% auf die Verkaufspreise inkl. MwSt.) ergibt sich ein Nettopreis ohne MwSt.. <i>On these prices we grant you a whole sale discount of - 50% (net without VAT).</i>
Sales conditions:	
Zahlungskonditionen:	Die ersten 3 Aufträge nur gegen Vorkasse abzgl. 3% Skonto. Folgeaufträge: 10 Tage 2% Skonto, 30 Tage netto. Bankeinzug 3%. Export nach Vereinbarung / <i>Export: subject to agreement</i>
Payment:	
Produkthaftung:	Kügele verpflichtet sich, ihren Kunden Entschädigungen zu ersetzen, die der Kunde auf Grund gesetzlicher Haftpflicht wegen eines Personen- oder Sachschadens hat leisten müssen. Dies gilt nur für Schäden, die nachweislich auf einen von Kügele verursachten Produktionsfehler zurückzuführen sind. Die Freistellung erfolgt nur in dem Umfang, in dem der Schaden von der Kügele verursacht ist. <i>Kügele will pay compensation, which they are legally obliged to pay, for personal or property damage. This applies only for damages which arise due to a fault in products of Kügele. Only the amount of damage directly caused by our products is covered.</i>
Product liability:	
Lieferkonditionen:	Die Lieferung erfolgt ausschließlich zu den auf unseren Rechnungen angeführten Bedingungen, insbesondere: Unter Eigentumsvorbehalt. Wir behalten uns das Eigentum an sämtlichen von uns gelieferten Waren bis zur Bezahlung unserer Gesamtforderungen aus der Geschäftsverbindung vor. Das gilt auch dann, wenn der Kaufpreis für bestimmte, vom Kunden bezeichnete Warenlieferungen bezahlt ist, da das vorbehaltene Eigentum als Sicherung für unsere Saldoforderung dient. <i>Delivery will only take place on basis of the conditions quoted in our invoices. In particular: with respect to reservation of proprietary rights. All our product deliveries remain our property until the total amount outstanding in the client's account has been paid. This applies irrespective of which invoices for which deliveries have been paid; any products remaining can be considered the property of Kügele.</i>
Deliveries:	
Lieferung Österreich und Deutschland:	Frachtfrei: ab einem Netto-Warenwert von € 200.-, frei Haus durch Spedition oder Paketdienst, Sendung unter € 50.- Warenwert, Frachtkostenanteil € 25.- Sendungen zwischen € 50.- und € 200.-, Frachtkostenanteil € 19.-. Bei Eigenzustellung am Wiener Platz verrechnen wir bis zu einem Netto-Warenwert von € 50.- eine Zustellgebühr von € 19.-, und bis € 200.- eine Zustellgebühr von € 13.-. Bei Abholung unter € 50.-: nur gegen Barrechnung.
Lieferung Ausland:	Mindestauftragswert € 500.-, ab Werk. Frei Haus auf Anfrage. <i>Minimum order € 500.-, prices ex works. Free domicile on request.</i>
Export delivery:	
Fracht und Verpackung:	Bei Bezug von Mengen unter einer kompletten Verpackungseinheit wird, um Transportschäden zu vermeiden, zusätzlich notwendiges Verpackungsmaterial verrechnet. Verpackungsholz für Länge 2,70 m, € 3,15,- netto. <i>For purchases of quantities smaller than a complete packing unit, additionally necessary packing material is charged in order to avoid transport damage. Packing timber for a length of 2,70 m: € 3.15,- (excl. VAT).</i>
Freight and Packing:	
Transportschäden:	Transportschäden können nur anerkannt werden, wenn die Beschädigung auf dem Übernahme-schein vermerkt wurde. Die Reklamationsfrist beträgt längstens eine Woche. Lieferungen von Mindermengen erfolgen auf Risiko des Käufers. Für Retoursendungen mit beschädigter Verpackung verrechnen wir eine 20%ige Manipulationsgebühr! <i>Damages in transit will only be accepted if the damage has been confirmed on the delivery note. The complaint period is one week from delivery. Small quantities are only delivered at the risk of the purchaser. For returns of goods in damaged packing a fee of 20% is payable.</i>
Damages in transit:	
Rücksendungen:	Rücksendungen werden nur nach Einholung unseres Einverständnisses und bei einwandfreiem Zustand der Ware und Verpackung innerhalb von 6 Wochen übernommen. Unverpackte Ware wird nicht übernommen und geht auf Kosten des Rücksenders retour. <i>Returns will only be accepted with our prior, written (faxed) agreement. Goods must be in the original packing and in salable condition. Reshipment for returns is at the cost of the returner.</i>
Returns:	
Manipulationsgebühr:	Bei von uns unverschuldeten Retouren, berechnen wir eine 30%ige Manipulationsgebühr, mindestens jedoch € 10.-. <i>For returns of goods that are not our fault, we charge a 30% handling fee, but at least € 10,-.</i>
Handling fee:	

NEU!

INHALTSVERZEICHNIS

VERLEGESYSTEME für LAMINAT und PARKETT

TGX	1A	Seite 11
Solum	1B	Seite 17
STS	1C	Seite 19
T-Flex	1D	Seite 23
Duo Grip Treppenkante	1E	Seite 15

1

VERLEGESYSTEME für LVT und Designbeläge

Cavum	2A	Seite 27
Configo	2B	Seite 29

2

MONOPROFILE

Winkelprofile	3A	Seite 31
Treppenkanten	3B	Seite 35
Abschlussprofile	3C	Seite 45
Übergangprofile	3D	Seite 51
Ausgleichprofile	3E	Seite 59
Klemmprofile	3F	Seite 65
Mauerkanten	3G	Seite 67
Kondenswasserprofile	3H	Seite 71
Einlagestreifen	3Y	Seite 73

3

RENOPROFILE

RENO-Treppenrenovierungsprofile	4.....	Seite 77
--	--------	----------

4

FLIESENPROFILE

Fliesenprofile	5A	Seite 81
Bewegungsfugen	5B	Seite 89
Biegeprofile	5C	Seite 97
Zubehör Fliesenprofile	5D	Seite 99

5

INHALTSVERZEICHNIS

EDELSTAHLPROFILE

6

6A.....	Seite 101	INOX Monoprofile
6B.....	Seite 105	INOX Fliesenprofile
6C.....	Seite 109	INOX Bewegungsfugen
6D.....	Seite 117	INOX Zubehör

HOLZDEKORPROFILE

7

7.....	Seite 119	Holzdekorprofile
--------	-----------	-------------------------

SOCKELLEISTEN

8

8A.....	Seite 121	Sockelleisten ALU
8B.....	Seite 125	Sockelleisten ALU Zubehör
8C.....	Seite 131	MDF Sockelleiste „regard“
8D.....	Seite 139	MDF Sockelleiste weiss „Alt Wien und Modern“
8E.....	Seite 143	Furnierte Massivsockelleiste „Modern“
8F.....	Seite 145	Dreikant und Schweizerleiste
8G.....	Seite 147	Furnierte Massivsockelleisten
8H.....	Seite 149	Heizrohr Sockelleiste
8I.....	Seite 151	Screasy Sockelleisten Schrauben
8J.....	Seite 151	Stahlstifte

UNTERLAGEN und TRITTSCHALL

9

9A.....	Seite 153	Greenwalk
9B.....	Seite 157	Aquastop
9C.....	Seite 159	Softflex
9D.....	Seite 161	PEP
9E.....	Seite 162	Steambrake
9F.....	Seite 163	Baufolie-Teppichstop-Vlies
9G.....	Seite 165	Bodenschutzmatten
9H.....	Seite 169	Terrasol - Bodenfliese

SCHLEIFMITTEL

10

10A.....	Seite 172	Schleifbänder
10B.....	Seite 173	Schleifscheiben
10C.....	Seite 173	Schleifpapier und Gitter

WERKZEUGE

11

Handschaber und Klingen	11A.....	Seite	176
Klingen	11B	Seite	177
Messer	11C	Seite	179
Reinigungspads	11D	Seite	182
Pinself	11E	Seite	183
Spachteln	11F.....	Seite	186
Zahnpachtel 180	11F2.....	Seite	187
Zahnpachtel 280	11F3.....	Seite	187
Mutterspachtel 180	11F3.....	Seite	188
Mutterspachtel 280	11F4.....	Seite	188
Zahnleiste 180	11F5.....	Seite	189
Zahnleiste 280	11F5.....	Seite	189
Rollmeter	11G	Seite	192
Werkzeug divers	11H	Seite	192
Müllsäcke	11I.....	Seite	196
Reinigung und Pflege	11Z.....	Seite	196

KUNSTSTOFF

12

Hartschaumsockelleiste	12A	Seite	197
Hartschaumsockelleiste Design	12B	Seite	203
Teppicheinfassprofile Kunststoff	12C	Seite	207
Weichkunststoffsockelleiste SL 50, SL 70 und SL 100	12D	Seite	209
Weichkunststoffsockelleiste WL50	12E	Seite	213
Mauerkanten Kunststoff	12F	Seite	215
PVC Hohlkehprofile und Treppenkanten	12G.....	Seite	217

KLEBPRODUKTE

13

SWITCHTEC	13A	Seite	219
Klebe-, Abdeck- und Verpackungsbänder	13B	Seite	225
Silikon, Acryl und Kleber	13C	Seite	227
Fugenmassen	13D	Seite	229

INHALTSVERZEICHNIS

Fix-o-moll

14

14.....Seite 231

14A.....Seite 246

Fix-o-moll

Tischtuchklammern

BOVELACCI

15

15A.....Seite 247

15B.....Seite 259

15C.....Seite 258

BOVELACCI Profile

BOVELACCI Rosetten

BOVELACCI Zubehör

EDELSTAHL / MESSING und SEILE

16

16A.....Seite 265

16B.....Seite 269

16C.....Seite 274

16D.....Seite 275

Edelstahl Treppenstangen

Messing Treppenstangen

Seilbeschläge

Seile

VERKAUFSTOOLS

17

17.....Seite 277

Module und Koffer

.....Seite 281

.....Seite 287

.....Seite 288

PRODUKTÜBERSICHT - INDEX

AGB Österreich

AGB Deutschland

ERLÄUTERUNG ZU DEN METALLPROFILIEN

Verpackungseinheiten ALU PROFILE:	5 oder 10 Stangen per Bund je nach Profiltyp 5 oder 10 SB per Bund je nach Profiltyp																																													
Einzelstangen:	Mindermengenzuschlag unter 1 VE: + 10%.																																													
Transport:	Auf Risiko des Kunden!																																													
Maße und Farben:	Die angegebenen Maße sind Richtwerte, produktionsbedingte Abweichungen und Verbesserungen vorbehalten! Farbabweichungen sind produktionsbedingt möglich!																																													
SB Profile:	Folienverpackt mit oder ohne Schrauben und Dübel, selbstklebend oder ungebohrt																																													
Zuschnitte:	Ein Transportschnitt ist möglich und gratis. Für mehrere Schnitte wird ein Zuschlag von 25% auf den Netto-Stangenpreis verrechnet. Entstehende Reste werden nur auf Wunsch mitgeliefert. Schnitttoleranz: +/- 3 mm. Die Rücknahme von Zuschnitten ist ausgeschlossen. Edelstahlprofile können generell nicht zugeschnitten oder gebohrt werden.																																													
Sonderanfertigung:	Bei Sonderanfertigungen behalten wir uns eine Über-/Unterlieferung von +/- 10% gegenüber der Bestellmenge vor. Die Rücknahme von Sonderprofilen oder RAL Beschichtungen ist ausgeschlossen!																																													
Einlagestreifen:	Profilpreise gelten immer ohne Einlagestreifen!																																													
Mindestbestimmungen und Lieferzeit für: Sortenrein, keine Sortierung möglich	<table><tr><td>ALU-ELOXAL/RAL-Bestellware:</td><td>ab 100 Stangen</td><td>ca. 5-8 Wochen</td></tr><tr><td>ALU/ELOXAL/RAL-ab VE Sondergebühr von € 400,-</td><td>bis 100 Stangen</td><td>ca. 5-8 Wochen</td></tr><tr><td>ALU-SONDERARTIKEL-ab Freigabe der Zeichnung</td><td>ab 300 kg</td><td>ca. 16 Wochen</td></tr><tr><td>RENO-TREPPENKANTEN-Bestellware</td><td>ab 500 kg</td><td>ca. 16 Wochen</td></tr><tr><td>- nur ab VE / Sondergebühr von € 400,-</td><td>ab 10 Stangen</td><td>ca. 20 Wochen</td></tr><tr><td>REGARD-LACKIERT-Bestellware</td><td>ab VE</td><td>ca. 2-3 Wochen</td></tr><tr><td>HOLZ-Bestellware/Sonderfarben</td><td>ab 500 lfm</td><td>ca. 5-6 Wochen</td></tr><tr><td>HOLZ-Dämmband Beschichtung</td><td>ab VE</td><td>ca. 2-3 Wochen</td></tr><tr><td>HZ-LEISTEN-Sonderfarben/Höhen</td><td>ab VE</td><td>ca. 2-5 Werktage</td></tr><tr><td>POLYMAT-MOTIV-Bestellware</td><td></td><td>ca. 3-4 Wochen</td></tr><tr><td>SCHLEIFSCHEIBEN Bestellware</td><td>ab VE</td><td>ca. 2-3 Wochen</td></tr><tr><td>BOLTA-Bestellware</td><td>ab 100 lfm</td><td>ca. 3-4 Wochen</td></tr><tr><td>DÖLLKEN-WL 50</td><td></td><td>ca. 3-4 Wochen</td></tr><tr><td>MAUERKANTE-Zuschnitt 150 cm</td><td></td><td>ca. 3-4 Werktage</td></tr><tr><td>TREPPENSTANGEN/SEILBESCHLÄGE</td><td></td><td>ca. 2-3 Wochen</td></tr></table>	ALU-ELOXAL/RAL-Bestellware:	ab 100 Stangen	ca. 5-8 Wochen	ALU/ELOXAL/RAL-ab VE Sondergebühr von € 400,-	bis 100 Stangen	ca. 5-8 Wochen	ALU-SONDERARTIKEL-ab Freigabe der Zeichnung	ab 300 kg	ca. 16 Wochen	RENO-TREPPENKANTEN-Bestellware	ab 500 kg	ca. 16 Wochen	- nur ab VE / Sondergebühr von € 400,-	ab 10 Stangen	ca. 20 Wochen	REGARD-LACKIERT-Bestellware	ab VE	ca. 2-3 Wochen	HOLZ-Bestellware/Sonderfarben	ab 500 lfm	ca. 5-6 Wochen	HOLZ-Dämmband Beschichtung	ab VE	ca. 2-3 Wochen	HZ-LEISTEN-Sonderfarben/Höhen	ab VE	ca. 2-5 Werktage	POLYMAT-MOTIV-Bestellware		ca. 3-4 Wochen	SCHLEIFSCHEIBEN Bestellware	ab VE	ca. 2-3 Wochen	BOLTA-Bestellware	ab 100 lfm	ca. 3-4 Wochen	DÖLLKEN-WL 50		ca. 3-4 Wochen	MAUERKANTE-Zuschnitt 150 cm		ca. 3-4 Werktage	TREPPENSTANGEN/SEILBESCHLÄGE		ca. 2-3 Wochen
ALU-ELOXAL/RAL-Bestellware:	ab 100 Stangen	ca. 5-8 Wochen																																												
ALU/ELOXAL/RAL-ab VE Sondergebühr von € 400,-	bis 100 Stangen	ca. 5-8 Wochen																																												
ALU-SONDERARTIKEL-ab Freigabe der Zeichnung	ab 300 kg	ca. 16 Wochen																																												
RENO-TREPPENKANTEN-Bestellware	ab 500 kg	ca. 16 Wochen																																												
- nur ab VE / Sondergebühr von € 400,-	ab 10 Stangen	ca. 20 Wochen																																												
REGARD-LACKIERT-Bestellware	ab VE	ca. 2-3 Wochen																																												
HOLZ-Bestellware/Sonderfarben	ab 500 lfm	ca. 5-6 Wochen																																												
HOLZ-Dämmband Beschichtung	ab VE	ca. 2-3 Wochen																																												
HZ-LEISTEN-Sonderfarben/Höhen	ab VE	ca. 2-5 Werktage																																												
POLYMAT-MOTIV-Bestellware		ca. 3-4 Wochen																																												
SCHLEIFSCHEIBEN Bestellware	ab VE	ca. 2-3 Wochen																																												
BOLTA-Bestellware	ab 100 lfm	ca. 3-4 Wochen																																												
DÖLLKEN-WL 50		ca. 3-4 Wochen																																												
MAUERKANTE-Zuschnitt 150 cm		ca. 3-4 Werktage																																												
TREPPENSTANGEN/SEILBESCHLÄGE		ca. 2-3 Wochen																																												

Änderungen und Irrtümer vorbehalten!

IMPORTANT HINTS FOR METAL PROFILES

Packing units ALU PROFILES:	5 or 10 profiles per unit, depending on type of profile. 5 or 10 D.I.Y. profiles per unit		
Non-standard packing units:	Non-standard packing units: + 10% extra charge		
Transport :	At the risk of the purchaser!		
Measures and colours:	The indicated measures are approximations, subject to manufacturing variations and innovations! Constant colours cannot be guaranteed due to production!		
D.I.Y. profiles:	Foil packed with or without screws or dowels, self-adhesive or undrilled		
Cut service:	One cut is free of charge. For further cuts a surcharge of + 25% of the net profile price applies. Off-cuts will only be delivered on request. Cutting tolerance: +/- 3 mm Cuts are excluded from return. Profiles made of stainless steel will generally not be cut or drilled.		
Custom-made products:	For custom-made products we reserve our right to an excess- or underdelivery of up to 10% of the order quantity. Custom-made profiles and RAL coated profiles are excluded from return.		
Insert strips:	Profile prices are general without insert strips!		
Minimum quantity of order and delivery time: sorted, mixing not possible	ALU-ANODIZATION/RAL coating - order goods	from 100 piece	app. 5-8 weeks
	ALU/ANODIZATION/RAL coating from 1 PU surcharge € 400.-	up to 100 piece	app. 5-8 weeks
	ALU-Custom-made profiles - after approval of the drawing	from 300 kg	app. 16 weeks
	RENO-stair renovation profiles - order goods	from 500 kg	app. 16 weeks
	- from 1 PU only surcharge € 400.-	from 10 pieces	app. 20 weeks
	REGARD lacquered - order goods	from packing unit	app. 2-3 weeks
	WOOD - order goods/ special colours	from 500 m	app. 5-6 weeks
	WOOD - application of draught-proof tape	from packing unit	app. 2-3 weeks
	HZ SKIRTINGS - special colours/ heights	from packing unit	app. 2-5 work days
	POLYMAT-MOTIV - order goods		app. 3-4 weeks
	ABRASIVE DISCS - order goods	from packing unit	app. 2-3 weeks
	BOLTA - order goods	from 100 m	app. 3-4 weeks
	DÖLLKEN-WL 50		app. 3-4 weeks
	WALL CORNER - cut 150 cm		app. 3-4 work days
	STAIR RODS / ROPE FITTINGS		app. 2-3 weeks

Errors & omissions excepted!

Wir fertigen für den Objektbereich Ihre Profile nach Ihren Maßen und Zeichnungen!
We manufacture your profiles for the contract sector according to your measurements and drawings!

LIEFERZEIT:

ab 300 kg ca. 16 Wochen
from 300 kg delivery time app. 16 weeks
 ab Freigabe der Zeichnung
after approval of the drawing

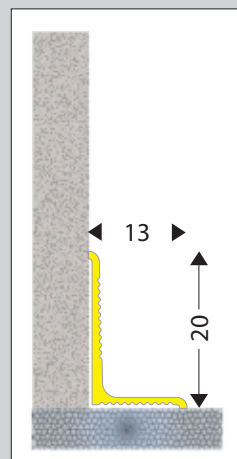
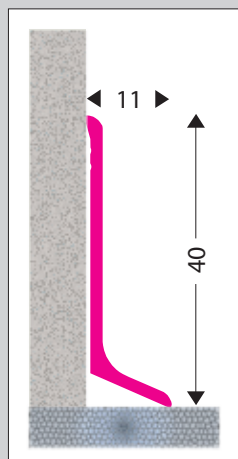
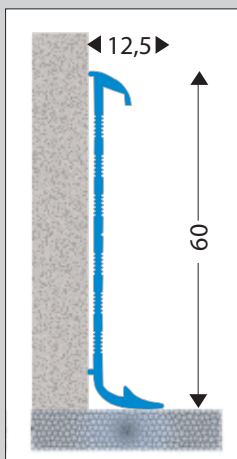
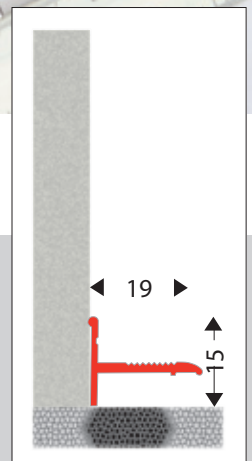
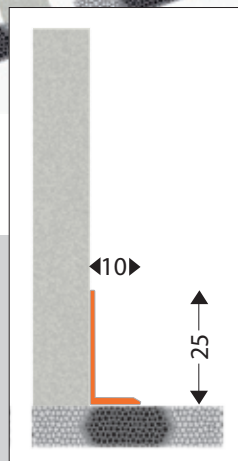
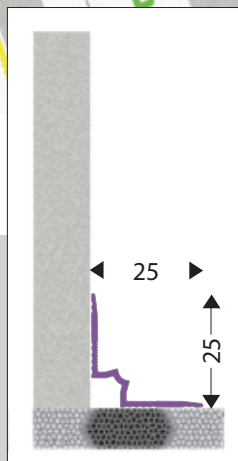
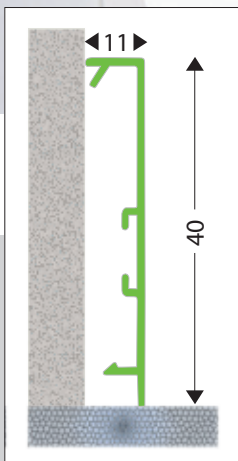

Symbolzeichnungen

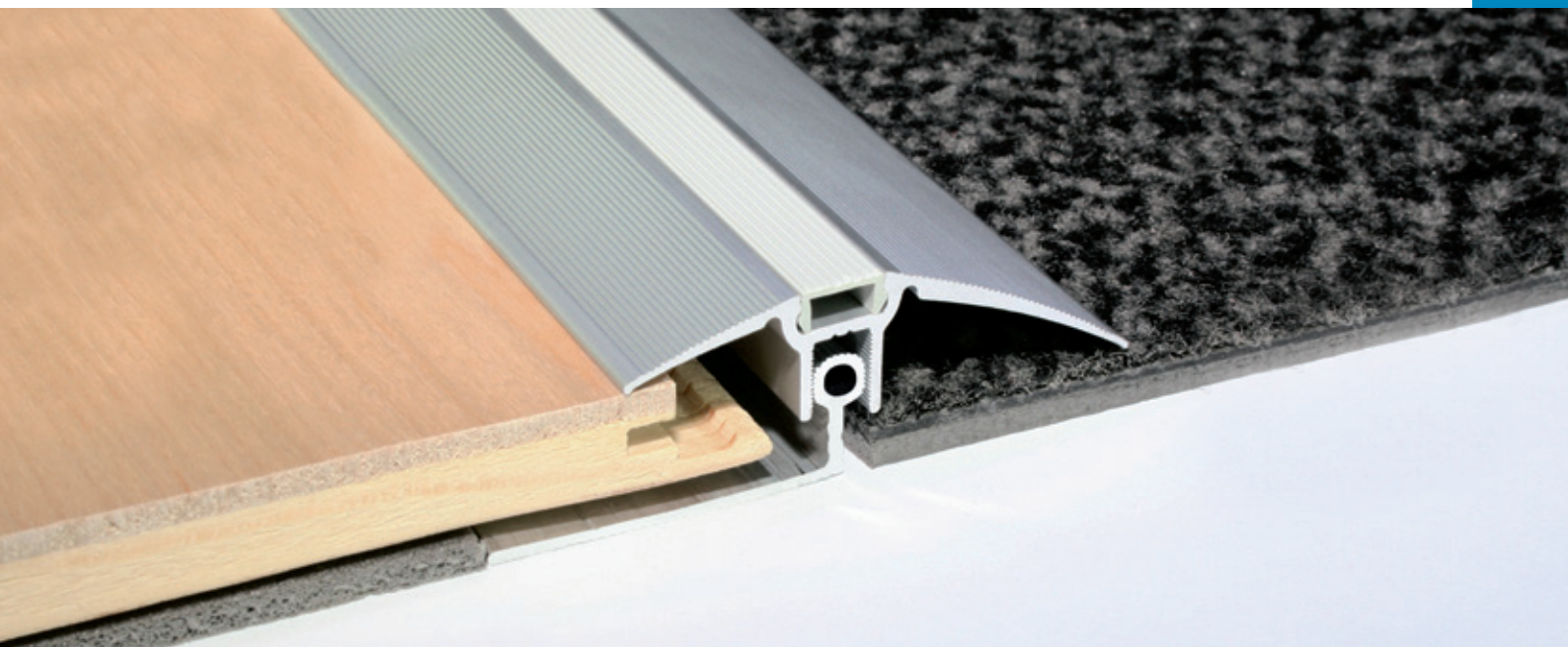

TRIO GRIP® x

3-teiliges Schraubsystem aus Aluminium
Das einzige Schraubsystem mit abgedecktem
Schraubenkanal!
höhenverstellbar, schwenkbar

*3-part screwing system in aluminium
The unique screwing profile system with
covered screw channel!
height adjustable, swiveling*

TRIO GRIP® x - 3-teiliges Schraubsystem, schwenkbar aus Aluminium, für Laminat und Parkett, mit gerilltem Kunststoff-Einlagestreifen zur Abdeckung des Schraubkanals

Einlagestreifen an der Längsseite des Deckprofils schräg ansetzen und auf der gegenüberliegenden Seite hineindrücken!
höhenverstellbar von 7,5 - 16,5 mm

SET inkl. Schrauben und Dübel, erhältlich in den Längen: 1 m und 2,70 m

TRIO GRIP® x - 3-part screwing system, swiveling, in aluminium, for laminate and parquet, with synthetic grooved insert strip to cover the screw channel

Align slantly insert strip at the long side of the cover profile and push it down on the opposite side!
height adjustable from 7,5 - 16,5 mm

Set incl. screws and dowels, available in lengths of 1 m and 2,70 m

TGX 100

ABSCHLUSSPROFIL 3-teilig

End profile - 3-part

höhenverstellbar/ height adjustable 7,5-16,5 mm

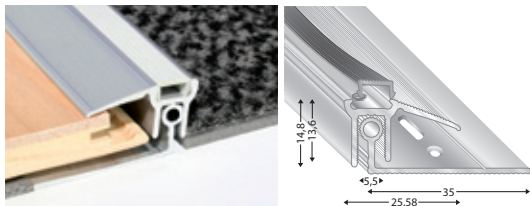

Artikel-Nr. article-no.	Farbe colour	VE unit
TGX100 S	silber/silver	S 5
TGX100 S 100		5
TGX100 SD	sand/sand	SD 5
TGX100 SD100		5
TGX100 G	gold/gold	G 5
TGX100 G 100		5
TGX100 B	bronze/bronze	B 5
TGX100 B 100		5
TGX100 EO	titan/EO	titan 5
TGX100 EO100		5

Preis/Stange price/piece		Preis/Stück price/piece	
270 cm	270 cm	100 cm	100 cm
Lagerware	Bestellware	Lagerware	Bestellware
58,52		23,85	
61,28		24,98	
	*		*
	*		*
62,53		25,48	

TGX 200

ÜBERGANGSPROFIL 3-teilig

Joining profile - 3-part

höhenverstellbar/ height adjustable 7,5-16,5 mm

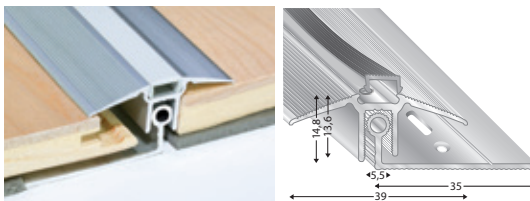

Artikel-Nr. article-no.	Farbe colour	VE unit
TGX200 S	silber/silver	S 5
TGX200 S 100		5
TGX200 SD	sand/sand	SD 5
TGX200 SD100		5
TGX200 G	gold/gold	G 5
TGX200 G 100		5
TGX200 B	bronze/bronze	B 5
TGX200 B 100		5
TGX200 EO	titan/EO	titan 5
TGX200 EO100		5

Preis/Stange price/piece		Preis/Stück price/piece	
270 cm	270 cm	100 cm	100 cm
Lagerware	Bestellware	Lagerware	Bestellware
61,28		24,98	
64,06		26,10	
	*		*
	*		*
65,35		26,63	

schwenkbar für Höhenausgleich maximal 14 mm
 swiveling for height compensation of max. 14 mm

TGX 300

AUSGLEICHSPROFIL 3-teilig

Level-adapting profile - 3-part

höhenverstellbar/ height adjustable 7,5-16,5 mm

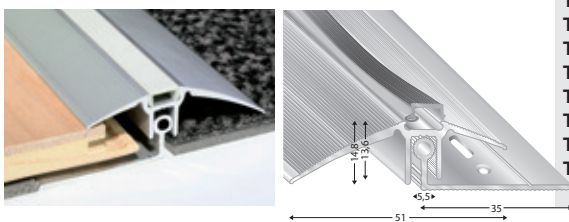

Artikel-Nr. article-no.	Farbe colour	VE unit
TGX300 S	silber/silver	S 5
TGX300 S 100		5
TGX300 SD	sand/sand	SD 5
TGX300 SD100		5
TGX300 G	gold/gold	G 5
TGX300 G 100		5
TGX300 B	bronze/bronze	B 5
TGX300 B 100		5
TGX300 EO	titan/EO	titan 5
TGX300 EO100		5

Preis/Stange price/piece		Preis/Stück price/piece	
270 cm	270 cm	100 cm	100 cm
Lagerware	Bestellware	Lagerware	Bestellware
69,51		28,32	
71,50		29,13	
	*		*
	*		*
72,96		29,72	

max. schwenkbar niedrige Position 0-7 mm
 max. swiveling lowest position 0-7 mm
 max. schwenkbar höchste Position 0-22 mm
 max. swiveling highest position 0-22 mm

* Preis auf Anfrage / price on request

TRIO GRIP® x - 3-teiliges Schraubsystem, schwenkbar aus Aluminium, für Laminat und Parkett, mit gerilltem Kunststoff-Einlagestreifen zur Abdeckung des Schraubkanals
höhenverstellbar mit Profil BASE 01 von 13 mm bis 21 mm
 SET inkl. Schrauben und Dübel, erhältlich in den Längen: 1 m und 2,70 m

TRIO GRIP® x - 3-part screwing system, swiveling, in aluminium, for laminate and parquet, with synthetic grooved insert strip to cover the screw channel
height adjustable with profile BASE 01 from 13 mm to 21 mm
 Set incl. screws and dowels, available in lengths of 1 m and 2,70 m

TGX 10A

ABSCHLUSSPROFIL 3-teilig
 End profile - 3-part
 höhenverstellbar/ height adjustable 13-21 mm

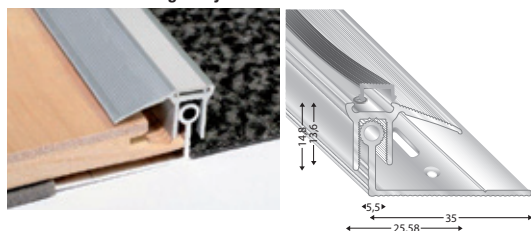

Artikel-Nr. article-no.	Farbe colour	VE unit	Preis/Stange price/piece		Preis/Stück price/piece	
			270 cm	270 cm	100 cm	100 cm
TGX10A S	silber/silver	S 5	64,25			
TGX10A S 100		5			26,17	
TGX10A SD	sand/sand	SD 5	66,94			
TGX10A SD100		5			27,27	
TGX10A G	gold/gold	G 5		*		
TGX10A G 100		5				*
TGX10A B	bronze/bronze	B 5		*		
TGX10A B 100		5				*
TGX10A EO	titan/EO	titan 5	68,49			
TGX10A EO100		5			27,90	

TGX 20A

ÜBERGANGSPROFIL 3-teilig
 Joining profile - 3-part
 höhenverstellbar/ height adjustable 13-21 mm

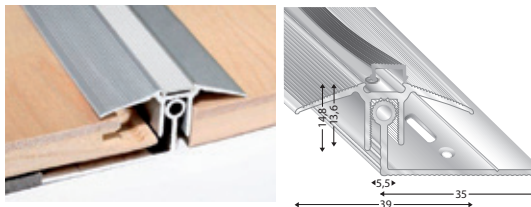

schwenkbar für Höhenausgleich maximal 14 mm
 swiveling for height compensation of max. 14 mm

Artikel-Nr. article-no.	Farbe colour	VE unit	Preis/Stange price/piece		Preis/Stück price/piece	
			270 cm	270 cm	100 cm	100 cm
TGX20A S	silber/silver	S 5	66,73			
TGX20A S 100		5			27,19	
TGX20A SD	sand/sand	SD 5	69,39			
TGX20A SD100		5			28,28	
TGX20A G	gold/gold	G 5		*		
TGX20A G 100		5				*
TGX20A B	bronze/bronze	B 5		*		
TGX20A B 100		5				*
TGX20A EO	titan/EO	titan 5	71,00			
TGX20A EO100		5			28,93	

TGX 30A

AUSGLEICHSPROFIL 3-teilig
 Level-adapting profile - 3-part
 höhenverstellbar/ height adjustable 13-21 mm

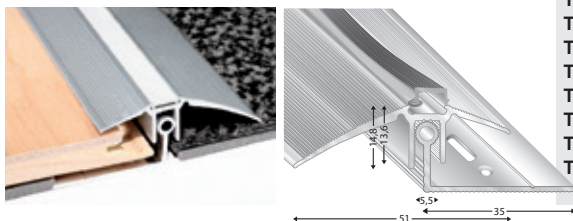

max. schwenkbar niedrige Position 0-14 mm
 max. swiveling lowest position 0-14 mm
 max. schwenkbar höchste Position 0-24 mm
 max. swiveling highest position 0-24 mm

Artikel-Nr. article-no.	Farbe colour	VE unit	Preis/Stange price/piece		Preis/Stück price/piece	
			270 cm	270 cm	100 cm	100 cm
TGX30A S	silber/silver	S 5	74,86			
TGX30A S 100		5			30,49	
TGX30A SD	sand/sand	SD 5	76,60			
TGX30A SD100		5			31,22	
TGX30A G	gold/gold	G 5		*		
TGX30A G 100		5				*
TGX30A B	bronze/bronze	B 5		*		
TGX30A B 100		5				*
TGX30A EO	titan/EO	titan 5	78,33			
TGX30A EO100		5			31,91	

KUNSTSTOFF EINLAGESTREIFEN Synthetic insert-strip

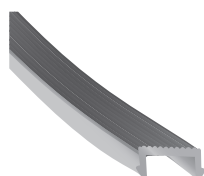

Artikel-Nr. article-no.	Farbe colour	VE unit	Preis/Stange price/piece		Preis/Stück price/piece	
			270 cm	270 cm	100 cm	100 cm
X990 S	silber/silver	S 5		*		
X990 S 100		5				*
X990 SD	sand/sand	SD 5		*		
X990 SD100		5				*
X990 G	gold/gold	G 5		*		
X990 G 100		5				*
X990 B	bronze/bronze	B 5		*		
X990 B 100		5				*
X990 EO	titan/EO	titan 5		*		
X990 EO100		5				*

* Preis auf Anfrage / price on request

TRIO GRIP® x flach - 3-teiliges Schraubsystem, aus Aluminium, für Laminat und Parkett, mit gerilltem Kunststoff-Einlagestreifen zur Abdeckung des Schraubkanals

Einlagestreifen an der Längsseite des Deckprofils schräg ansetzen und auf der gegenüberliegenden Seite hineindrücken!

TGX® 233 flach, höhenverstellbar von 7 – 15 mm, mit Profil BASE 06 von 15 mm bis 22 mm

SET inkl. Schrauben und Dübel, erhältlich in den Längen: 1 m und 2,70 m

TRIO GRIP® x flat - 3-part screwing system, in aluminium, for laminate and parquet, with synthetic grooved insert strip to cover screw channel

Align slantly insert strip at the long side of the cover profile and push it down on the opposite side!

TGX® 233 flat, height adjustable from 7 – 15 mm, with profile BASE 06 from 15 mm to 22 mm

Set incl. screws and dowels, available in lengths of 1 m and 2,70 m

TGX 233

ÜBERGANGSPROFIL flach 3-teilig

Joining profile flat - 3-part

Höhen / heights 7-15 mm

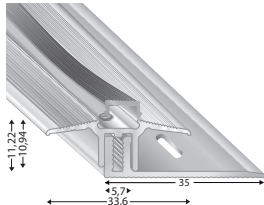

Artikel-Nr. article-no.	Farbe colour	VE unit
TGX233 S	silber/silver	S 5
TGX233 S 100		5
TGX233 SD	sand/sand	SD 5
TGX233 SD100		5
TGX233 G	gold/gold	G 5
TGX233 G 100		5
TGX233 B	bronze/bronze	B 5
TGX233 B 100		5
TGX233 EO	titan/EO	titan 5
TGX233 EO100		5

Preis/Stange price/piece		Preis/Stück price/piece	
270 cm	270 cm	100 cm	100 cm
Lagerware	Bestellware	Lagerware	Bestellware
59,42		24,20	
62,14		25,31	
	*		*
	*		*
63,37		25,81	

TGX 23A

ÜBERGANGSPROFIL flach 3-teilig

Joining profile flat - 3-part

höhenverstellbar / height adjustable 15-22 mm

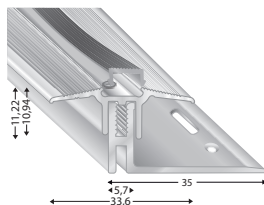

Artikel-Nr. article-no.	Farbe colour	VE unit
TGX23A S	silber/silver	S 5
TGX23A S 100		5
TGX23A SD	sand/sand	SD 5
TGX23A SD100		5
TGX23A G	gold/gold	G 5
TGX23A G 100		5
TGX23A B	bronze/bronze	B 5
TGX23A B 100		5
TGX23A EO	titan/EO	titan 5
TGX23A EO100		5

Preis/Stange price/piece		Preis/Stück price/piece	
270 cm	270 cm	100 cm	100 cm
Lagerware	Bestellware	Lagerware	Bestellware
66,00		26,88	
68,76		28,01	
	*		*
	*		*
70,31		28,63	

KUNSTSTOFF EINLAGESTREIFEN Synthetic insert-strip

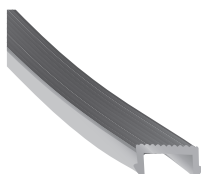

Artikel-Nr. article-no.	Farbe colour	VE unit
X990 S	silber/silver	S 5
X990 S 100		5
X990 SD	sand/sand	SD 5
X990 SD100		5
X990 G	gold/gold	G 5
X990 G 100		5
X990 B	bronze/bronze	B 5
X990 B 100		5
X990 EO	titan/EO	titan 5
X990 EO100		5

Preis/Stange price/piece		Preis/Stück price/piece	
270 cm	270 cm	100 cm	100 cm
Lagerware	Bestellware	Lagerware	Bestellware
	*		*
	*		*
	*		*
	*		*
	*		*
	*		*

* Preis auf Anfrage / price on request

TRIO GRIP® Schraubensystem aus Aluminium für Laminat und Parkett TREPPENKANTEN - komplett

Deck-, und Grundprofile, Einlagestreifen, inkl. Befestigungsmaterial bestehend aus Schrauben und Dübel zur Montage des Grundprofils und 3 Set Schrauben zur höhenvariablen Befestigung des Deckprofils im Grundprofil.

HINWEIS: die Höhenverstellbarkeit ist so berechnet, dass unter dem Boden eine 2-3 mm starke Unterlage verwendet wird. Sollte auf dem Boden bereits eine Unterlage aufkaschiert sein, so ist diese von der Gesamthöhe abzuziehen. Beispiel: ein 8 mm Boden/Laminat mit einer aufkaschierten 2 mm Unterlage ist als 8 mm Boden zu sehen!

TRIO GRIP® screwing system in aluminium for laminate and parquet STAIR NOSINGS - complete

Cover profile, grooved insert strip and base profile incl. mounting material, screws and dowels for mounting the base profile and 3 sets of screws for the height-adjustable assembling of the cover profile in the base profile.

HINTS: Calculation of the height adjustability of the profile includes allowance for a 2-3 mm thick underlay. Where a floor has a bonded underlay, the thickness of the underlay should be subtracted from the total floor size to obtain the thickness of the flooring. Example: an 8 mm laminate flooring (or alternatively the floor itself) with a bonded underlay of 2 mm is equivalent to an 8 mm thick flooring!

Artikel-Nr. article-no.	Farbe colour	VE unit	Preis/Stange price/piece	
			270 cm	270 cm
LP 9600	silber/silver	5		
TREPPENPROFIL 3-teilig, gebohrt Stair nosing profile - 3-part, drilled Höhen / heights 8-15 mm			Lagerware	Bestellware
			86,51	

Artikel-Nr. article-no.	Farbe colour	VE unit	Preis/Stange price/piece	
			270 cm	270 cm
9900 S	silber/silver	5		
KUNSTSTOFF EINLAGESTREIFEN Synthetic insert-strip			Lagerware	Bestellware
				*

DUO GRIP Treppenprofil 3-teiliges Klemmsystem mit Nylon-Clipschiene, schraublos, aus Aluminium für Laminat und Parkett

Höhen von 6 - 10 mm

SET inkl. Schrauben und Dübel, erhältlich in den Längen: 2,70 m

DUO GRIP stair nosing profile - 3-part clip system with nylon clip profile, screwless, in aluminium for laminate and parquet heights from 6 - 10 mm

Set incl. screws and dowels, available in lengths of 2,70 m

Artikel-Nr. article-no.	Farbe colour	VE unit	Preis/Stange price/piece	
			270 cm	270 cm
2600	silber/silver	5		
TREPPENPROFIL 3-teilig Stair nosing profile - 3-part Höhen / heights 6-10 mm			Lagerware	Bestellware
			88,37	



SOLUM

2-teiliges Schraubsystem aus Aluminium
höhenverstellbar, schwenkbar

*2-part screwing system in aluminium
height adjustable, swiveling*

SOLUM® - 2-teiliges Schraubsystem, schwenkbar aus Aluminium, für Laminat und Parkett höhenverstellbar von 7 – 16 mm, mit Lifter bis 24 mm

SET inkl. Schrauben und Dübel, erhältlich in den Längen: 1 m und 2,70 m

SOLUM® - 2-part screwing system, swiveling in aluminium, for laminate and parquet height adjustable from 7 – 16 mm, with lifter up to 24 mm

Set incl. screws and dowels, available in lengths of 1 m and 2,70 m

A 79127

ABSCHLUSSPROFIL 2-teilig, gebohrt
End profile - 2-part, drilled
höhenverstellbar / height adjustable 7-16 mm



Artikel-Nr. article-no.	Farbe colour	VE unit
A79127 20	silber/silver	10
A79127 20100		10
A79127 25	sand/sand	10
A79127 25100		10
A79127 30	gold/gold	10
A79127 30100		10
A79127 40	bronze/bronze	10
A79127 40100		10
A79127 15	titan/EO	10
A79127 15100		10

Preis/Stange price/piece		Preis/Stück price/piece	
270 cm	270 cm	100 cm	100 cm
Lagerware	Bestellware	Lagerware	Bestellware
69,49			
72,79		28,32	
	*	29,66	
			*
75,09			*
		30,60	

A 79125

ÜBERGANGSPROFIL 2-teilig, gebohrt
Joining profile - 2-part, drilled
höhenverstellbar / height adjustable 7-16 mm



Artikel-Nr. article-no.	Farbe colour	VE unit
A79125 20	silber/silver	10
A79125 20100		10
A79125 25	sand/sand	10
A79125 25100		10
A79125 30	gold/gold	10
A79125 30100		10
A79125 40	bronze/bronze	10
A79125 40100		10
A79125 15	titan/EO	10
A79125 15100		10

Preis/Stange price/piece		Preis/Stück price/piece	
270 cm	270 cm	100 cm	100 cm
Lagerware	Bestellware	Lagerware	Bestellware
69,76			
73,23		28,44	
	*	29,85	
			*
75,47			*
		30,76	

max. schwenkbar niedrige Position 4-10 mm
max. swiveling lowest position 4-10 mm
max. schwenkbar höchste Position 7-20 mm
max. swiveling highest position 7-20 mm

A 79129

AUSGLEICHSPROFIL 2-teilig, gebohrt
Level-adapting profile - 2-part, drilled
höhenverstellbar / height adjustable 7-16 mm



Artikel-Nr. article-no.	Farbe colour	VE unit
A79129 20	silber/silver	10
A79129 20100		10
A79129 25	sand/sand	10
A79129 25100		10
A79129 30	gold/gold	10
A79129 30100		10
A79129 40	bronze/bronze	10
A79129 40100		10
A79129 15	titan/EO	10
A79129 15100		10

Preis/Stange price/piece		Preis/Stück price/piece	
270 cm	270 cm	100 cm	100 cm
Lagerware	Bestellware	Lagerware	Bestellware
77,14			
81,53		31,43	
	*	33,21	
			*
84,44			*
		34,40	

max. schwenkbar niedrige Position 0-7 mm
max. swiveling lowest position 0-7 mm
max. schwenkbar höchste Position 2-16 mm
max. swiveling highest position 2-16 mm

LIFT 02

LIFTER
Mit Lifter 02 bis 24 mm
With Lifter 02 up to 24 mm



Artikel-Nr. article-no.	Farbe colour	VE unit
LIFT 02	roh/raw	5
LIFT 02 100		5

Preis/Stange price/piece		Preis/Stück price/piece	
270 cm	270 cm	100 cm	100 cm
Lagerware	Bestellware	Lagerware	Bestellware
41,82			
		17,03	

Anwendung/application

* Preis auf Anfrage / price on request



STS

2-teiliges Schraubsystem aus Aluminium
höhenverstellbar

*2-part screwing system in aluminium
height adjustable*

STS - 2-teiliges Schraubsystem, aus Aluminium, für Laminat und Parkett
höhenverstellbar von 7,5 - 15 mm

SET inkl. Schrauben und Dübel, erhältlich in den Längen: 1 m und 2,70 m

STS - 2-part screwing system, in aluminium, for laminate and parquet
height adjustable from 7,5 - 15 mm

Set incl. screws and dowels, available in lengths of 1 m and 2,70 m

STS 21

ABSCHLUSSPROFIL 2-teilig, gebohrt
End profile - 2-part, drilled
 höhenverstellbar / *height adjustable* 7,5-15 mm

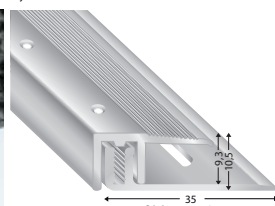

Artikel-Nr. article-no.	Farbe colour	VE unit
STS21 S	silber/silver	S 10
STS21 S 100		10
STS21 SD	sand/sand	SD 10
STS21 SD 100		10
STS21 G	gold/gold	G 10
STS21 G 100		10
STS21 B	bronzel/bronze	B 10
STS21 B 100		10
STS21 EO	titan/EO	titan 10
STS21 EO 100		10

Preis/Stange price/piece		Preis/Stück price/piece	
270 cm	270 cm	100 cm	100 cm
Lagerware	Bestellware	Lagerware	Bestellware
40,50		16,64	
41,55		17,08	
41,55		17,08	
40,73		16,76	
40,73		16,76	

STS 33

ÜBERGANGSPROFIL 2-teilig, gebohrt
Joining profile - 2-part, drilled
 höhenverstellbar / *height adjustable* 7,5-15 mm

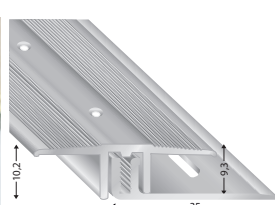

Artikel-Nr. article-no.	Farbe colour	VE unit
STS33 S	silber/silver	S 10
STS33 S 100		10
STS33 SD	sand/sand	SD 10
STS33 SD 100		10
STS33 G	gold/gold	G 10
STS33 G 100		10
STS33 B	bronzel/bronze	B 10
STS33 B 100		10
STS33 EO	titan/EO	titan 10
STS33 EO 100		10

Preis/Stange price/piece		Preis/Stück price/piece	
270 cm	270 cm	100 cm	100 cm
Lagerware	Bestellware	Lagerware	Bestellware
44,43		18,29	
46,02		18,94	
46,02		18,94	
44,96		18,50	
44,96		18,50	

STS 44

AUSGLEICHSPROFIL 2-teilig, gebohrt
Level-adapting profile - 2-part, drilled
 höhenverstellbar / *height adjustable* 7,5-15 mm

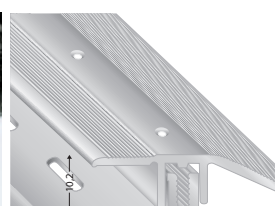

Artikel-Nr. article-no.	Farbe colour	VE unit
STS44 S	silber/silver	S 10
STS44 S 100		10
STS44 SD	sand/sand	SD 10
STS44 SD 100		10
STS44 G	gold/gold	G 10
STS44 G 100		10
STS44 B	bronzel/bronze	B 10
STS44 B 100		10
STS44 EO	titan/EO	titan 10
STS44 EO 100		10

Preis/Stange price/piece		Preis/Stück price/piece	
270 cm	270 cm	100 cm	100 cm
Lagerware	Bestellware	Lagerware	Bestellware
52,63		21,63	
54,67		22,49	
54,67		22,49	
53,40		21,95	
53,40		21,95	

max. schwenkbar niedrige Position 0-7 mm
 max. swiveling lowest position 0-7 mm
 max. schwenkbar höchste Position 0-15 mm
 max. swiveling highest position 0-15 mm

STS - 2-teiliges Schraubsystem, aus Aluminium, für Laminat und Parkett höhenverstellbar mit Profil BASE 03 von 15 mm bis 22 mm

SET inkl. Schrauben und Dübel, erhältlich in den Längen: 1 m und 2,70 m

STS - 2-part screwing system, in aluminium, for laminate and parquet height adjustable with profile BASE 03 from 15 mm to 22 mm

Set incl. screws and dowels, available in lengths of 1 m and 2,70 m

STS 21A

ABSCHLUSSPROFIL 2-teilig, gebohrt
End profile - 2-part, drilled
höhenverstellbar / height adjustable 15-22 mm

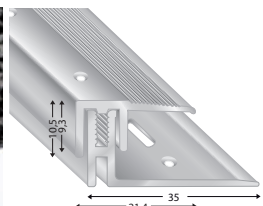
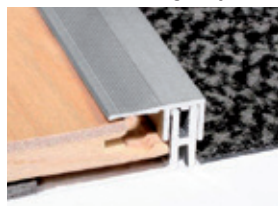

Artikel-Nr. article-no.	Farbe colour	VE unit	Preis/Stange price/piece		Preis/Stück price/piece	
			270 cm	270 cm	100 cm	100 cm
STS21A S	silber/silver	S	10			
STS21A S 100			10			
STS21A SD	sand/sand	SD	10	*		*
STS21A SD 100			10			*
STS21A G	gold/gold	G	10	*		*
STS21A G 100			10			*
STS21A B	bronze/bronze	B	10	*		*
STS21A B 100			10			*
STS21A EO	titan/EO	titan	10	*		*
STS21A EO 100			10			*

Preis/Stange price/piece		Preis/Stück price/piece	
270 cm	270 cm	100 cm	100 cm
Lagerware	Bestellware	Lagerware	Bestellware
45,56		18,73	

STS 33A

ÜBERGANGSPROFIL 2-teilig, gebohrt
Joining profile - 2-part, drilled
höhenverstellbar / height adjustable 15-22 mm

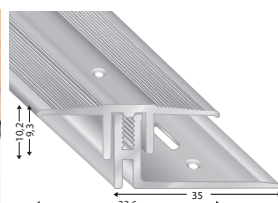

Artikel-Nr. article-no.	Farbe colour	VE unit	Preis/Stange price/piece		Preis/Stück price/piece	
			270 cm	270 cm	100 cm	100 cm
STS33A S	silber/silver	S	10			
STS33A S 100			10			
STS33A SD	sand/sand	SD	10	*		*
STS33A SD 100			10			*
STS33A G	gold/gold	G	10	*		*
STS33A G 100			10			*
STS33A B	bronze/bronze	B	10	*		*
STS33A B 100			10			*
STS33A EO	titan/EO	titan	10	*		*
STS33A EO 100			10			*

Preis/Stange price/piece		Preis/Stück price/piece	
270 cm	270 cm	100 cm	100 cm
Lagerware	Bestellware	Lagerware	Bestellware
49,51		20,38	

STS 44A

AUSGLEICHSPROFIL 2-teilig, gebohrt
Level-adapting profile - 2-part, drilled
höhenverstellbar / height adjustable 15-22 mm

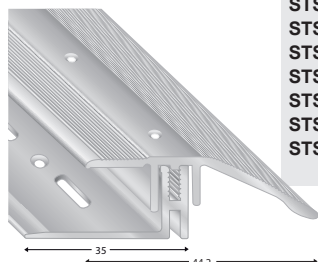

Artikel-Nr. article-no.	Farbe colour	VE unit	Preis/Stange price/piece		Preis/Stück price/piece	
			270 cm	270 cm	100 cm	100 cm
STS44A S	silber/silver	S	10			
STS44A S 100			10			
STS44A SD	sand/sand	SD	10	*		*
STS44A SD 100			10			*
STS44A G	gold/gold	G	10	*		*
STS44A G 100			10			*
STS44A B	bronze/bronze	B	10	*		*
STS44A B 100			10			*
STS44A EO	titan/EO	titan	10	*		*
STS44A EO 100			10			*

Preis/Stange price/piece		Preis/Stück price/piece	
270 cm	270 cm	100 cm	100 cm
Lagerware	Bestellware	Lagerware	Bestellware
51,27		23,68	

max. schwenkbar niedrige Position 5-13 mm
max. swiveling lowest position 5-13 mm
max. schwenkbar höchste Position 12-22 mm
max. swiveling highest position 12-22 mm

* Preis auf Anfrage / price on request



T-FLEX

2-teiliges Klemmsystem aus Aluminium
höhenverstellbar, schwenkbar

*2-part clip system in aluminium
height adjustable, swiveling*

T-FLEX

T-FLEX - 2-teiliges Klemmsystem, schraublos, schwenkbar, aus Aluminium, für Laminat und Parkett
höhenverstellbar von 7 - 13 mm

SET inkl. Schrauben und Dübel, erhältlich in den Längen: 1 m und 2,70 m

T-FLEX - 2-part clip system, screwless, swiveling, in aluminium, for laminate and parquet
height adjustable from 7 - 13 mm

Set incl. screws and dowels, available in lengths of 1 m and 2,70 m

TF 520

ABSCHLUSSPROFIL 2-teilig

End profile - 2-part

höhenverstellbar / height adjustable 7-13 mm



Artikel-Nr. article-no.	Farbe colour	VE unit
TF520 S	silber/silver	10
TF520 S 100		10
TF520 SD	sand/sand	10
TF520 SD 100		10
TF520 G	gold/gold	10
TF520 G 100		10
TF520 B	bronze/bronze	10
TF520 B 100		10
TF520 EO	titan/EO	10
TF520 EO 100		10

Artikel-Nr. / article-no. Farbe / colour VE / unit

Preis/Stange price/price		Preis/Stück price/price	
270 cm	270 cm	100 cm	100 cm
Lagerware	Bestellware	Lagerware	Bestellware
36,41		14,84	
38,00		15,49	
	*		*
	*		*
38,41		15,65	

TF 530

ÜBERGANGSPROFIL 2-teilig

Joining profile - 2-part

höhenverstellbar / height adjustable 7-13 mm



Artikel-Nr. article-no.	Farbe colour	VE unit
TF530 S	silber/silver	10
TF530 S 100		10
TF530 SD	sand/sand	10
TF530 SD 100		10
TF530 G	gold/gold	10
TF530 G 100		10
TF530 B	bronze/bronze	10
TF530 B 100		10
TF530 EO	titan/EO	10
TF530 EO 100		10

Artikel-Nr. / article-no. Farbe / colour VE / unit

Preis/Stange price/price		Preis/Stück price/price	
270 cm	270 cm	100 cm	100 cm
Lagerware	Bestellware	Lagerware	Bestellware
37,85		15,42	
39,50		16,09	
	*		*
	*		*
39,96		16,28	

schwenkbar für Höhenausgleich maximal 5 mm
 swiveling for height compensation of max. 5 mm

TF 550

ÜBERGANGSPROFIL 2-teilig

Joining profile - 2-part

höhenverstellbar / height adjustable 7-13 mm

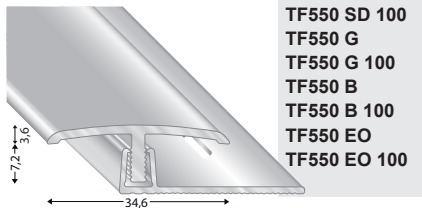

Artikel-Nr. article-no.	Farbe colour	VE unit
TF550 S	silber/silver	10
TF550 S 100		10
TF550 SD	sand/sand	10
TF550 SD 100		10
TF550 G	gold/gold	10
TF550 G 100		10
TF550 B	bronze/bronze	10
TF550 B 100		10
TF550 EO	titan/EO	10
TF550 EO 100		10

Artikel-Nr. / article-no. Farbe / colour VE / unit

Preis/Stange price/price		Preis/Stück price/price	
270 cm	270 cm	100 cm	100 cm
Lagerware	Bestellware	Lagerware	Bestellware
40,02		17,22	
45,73		19,69	
	*		*
	*		*
	*		*

schwenkbar für Höhenausgleich maximal 5 mm
 swiveling for height compensation of max. 5 mm

TF 540

AUSGLEICHSPROFIL 2-teilig

Level-adapting profile - 2-part

höhenverstellbar / height adjustable 7-13 mm



Artikel-Nr. article-no.	Farbe colour	VE unit
TF540 S	silber/silver	10
TF540 S 100		10
TF540 SD	sand/sand	10
TF540 SD 100		10
TF540 G	gold/gold	10
TF540 G 100		10
TF540 B	bronze/bronze	10
TF540 B 100		10
TF540 EO	titan/EO	10
TF540 EO 100		10

Artikel-Nr. / article-no. Farbe / colour VE / unit

Preis/Stange price/price		Preis/Stück price/price	
270 cm	270 cm	100 cm	100 cm
Lagerware	Bestellware	Lagerware	Bestellware
45,42		18,52	
47,40		19,31	
	*		*
	*		*
	*		*

max. schwenkbar niedrige Position 0-7 mm
 max. swiveling lowest position 0-7 mm
 max. schwenkbar höchste Position 0-12 mm
 max. swiveling highest position 0-12 mm

* Preis auf Anfrage / price on request

T-FLEX - 2-teiliges Klemmsystem, schraublos, schwenkbar, aus Aluminium, für Laminat und Parkett
höhenverstellbar mit Profil BASE 04 von 13 mm bis 18 mm
 SET inkl. Schrauben und Dübel, erhältlich in den Längen: 1 m und 2,70 m

T-FLEX - 2-part clip system, screwless, swiveling, in aluminium, for laminate and parquet
height adjustable with profile BASE 04 from 13 mm to 18 mm
 Set incl. screws and dowels, available in lengths of 1 m and 2,70 m

TF 52A

ABSCHLUSSPROFIL 2-teilig

End profile - 2-part

höhenverstellbar / height adjustable 13-18 mm



Artikel-Nr.
article-no.

Farbe
colour

VE
unit

Preis/Stange
price/price

Preis/Stück
price/price

TF52A S
TF52A S 100
TF52A SD
TF52A SD 100
TF52A G
TF52A G 100
TF52A B
TF52A B 100
TF52A EO
TF52A EO 100

silber/silver
sand/sand
gold/gold
bronze/bronze
titan/EO

S
SD
G
B
titan

10
10
10
10
10
10
10
10
10
10

270 cm		270 cm	
Lagerware	Bestellware	Lagerware	Bestellware
42,16			
43,68		*	
		*	
		*	
		*	

100 cm		100 cm	
Lagerware	Bestellware	Lagerware	Bestellware
17,18			
17,81			*
			*
			*
			*

TF 53A

ÜBERGANGSPROFIL 2-teilig

Joining profile - 2-part

höhenverstellbar / height adjustable 13-18 mm



Artikel-Nr.
article-no.

Farbe
colour

VE
unit

Preis/Stange
price/price

Preis/Stück
price/price

TF53A S
TF53A S 100
TF53A SD
TF53A SD 100
TF53A G
TF53A G 100
TF53A B
TF53A B 100
TF53A EO
TF53A EO 100

silber/silver
sand/sand
gold/gold
bronze/bronze
titan/EO

S
SD
G
B
titan

10
10
10
10
10
10
10
10
10
10

270 cm		270 cm	
Lagerware	Bestellware	Lagerware	Bestellware
43,45			
45,00		*	
		*	
		*	
		*	

100 cm		100 cm	
Lagerware	Bestellware	Lagerware	Bestellware
17,70			
18,33			*
			*
			*
			*

schwenkbar für Höhenausgleich maximal 5 mm
swiveling for height compensation of max. 5 mm

TF 55A

ÜBERGANGSPROFIL 2-teilig

Joining profile - 2-part

höhenverstellbar / height adjustable 13-18 mm

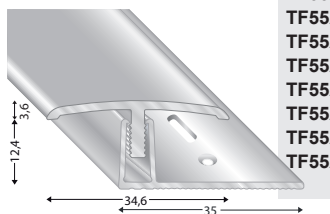

Artikel-Nr.
article-no.

Farbe
colour

VE
unit

Preis/Stange
price/price

Preis/Stück
price/price

TF55A S
TF55A S 100
TF55A SD
TF55A SD 100
TF55A G
TF55A G 100
TF55A B
TF55A B 100
TF55A EO
TF55A EO 100

silber/silver
sand/sand
gold/gold
bronze/bronze
titan/EO

S
SD
G
B
titan

10
10
10
10
10
10
10
10
10
10

270 cm		270 cm	
Lagerware	Bestellware	Lagerware	Bestellware
45,69			
52,21		*	
		*	
		*	
		*	

100 cm		100 cm	
Lagerware	Bestellware	Lagerware	Bestellware
17,95			
20,52			*
			*
			*
			*

schwenkbar für Höhenausgleich maximal 5 mm
swiveling for height compensation of max. 5 mm

TF 54A

AUSGLEICHSPROFIL 2-teilig

Level-adapting profile - 2-part

höhenverstellbar / height adjustable 13-17 mm



Artikel-Nr.
article-no.

Farbe
colour

VE
unit

Preis/Stange
price/price

Preis/Stück
price/price

TF54A S
TF54A S 100
TF54A SD
TF54A SD 100
TF54A G
TF54A G 100
TF54A B
TF54A B 100
TF54A EO
TF54A EO 100

silber/silver
sand/sand
gold/gold
bronze/bronze
titan/EO

S
SD
G
B
titan

10
10
10
10
10
10
10
10
10
10

270 cm		270 cm	
Lagerware	Bestellware	Lagerware	Bestellware
52,15			
54,01		*	
		*	
		*	
		*	

100 cm		100 cm	
Lagerware	Bestellware	Lagerware	Bestellware
21,23			
21,99			*
			*
			*
			*

max. schwenkbar niedrige Position 0-13 mm
max. swiveling lowest position 0-13 mm
max. schwenkbar höchste Position 5-17 mm
max. swiveling highest position 5-17 mm

* Preis auf Anfrage / price on request



CAVUM

2-teiliges Schraubsystem aus Aluminium
höhenverstellbar, schwenkbar

*2-part screwing system in aluminium
height adjustable, swiveling*

CAVUM - 2-teiliges Schraubsystem, schwenkbar, aus Aluminium, für LVT und Designbeläge
höhenverstellbar von 3,9 - 7,6 mm
 SET inkl. Schrauben und Dübel, erhältlich in den Längen: 1 m und 2,70 m

CAVUM - 2-part screwing system, swiveling, in aluminium, for LVT and design floorings
height adjustable from 3,9 - 7,6 mm
 Set incl. screws and dowels, available in lengths of 1 m and 2,70 m

79177

ABSCHLUSSPROFIL 2-teilig, gebohrt
End profile - 2-part, drilled
 höhenverstellbar / height adjustable 3,9-7,6 mm

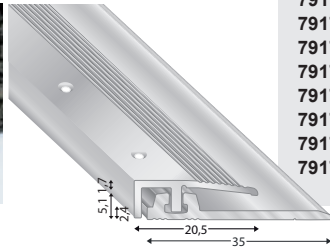

Artikel-Nr. article-no.	Farbe colour	VE unit
79177 20	silber/silver	10
79177 20 100		10
79177 25	sand/sand	10
79177 25 100		10
79177 30	gold/gold	10
79177 30 100		10
79177 40	bronze/bronze	10
79177 40 100		10
79177 15	titan/EO	10
79177 15 100		10

Preis/Stange price/piece		Preis/Stück price/piece	
270 cm	270 cm	100 cm	100 cm
Lagerware	Bestellware	Lagerware	Bestellware
44,87		17,20	
47,88		18,31	
	*		*
49,34		18,89	

79175

ÜBERGANGSPROFIL 2-teilig, gebohrt
Joining profile - 2-part, drilled
 höhenverstellbar / height adjustable 3,9-7,6 mm

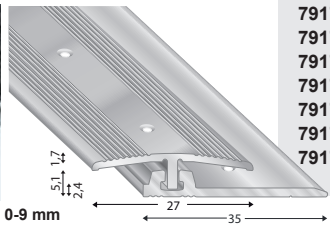

Artikel-Nr. article-no.	Farbe colour	VE unit
79175 20	silber/silver	10
79175 20 100		10
79175 25	sand/sand	10
79175 25 100		10
79175 30	gold/gold	10
79175 30 100		10
79175 40	bronze/bronze	10
79175 40 100		10
79175 15	titan/EO	10
79175 15 100		10

Preis/Stange price/piece		Preis/Stück price/piece	
270 cm	270 cm	100 cm	100 cm
Lagerware	Bestellware	Lagerware	Bestellware
45,83		17,51	
48,89		18,75	
	*		*
50,41		19,31	

max. schwenkbar niedrige Position 0-9 mm
 max. swiveling lowest position 0-9 mm
 max. schwenkbar höchste Position 3-10 mm
 max. swiveling highest position 3-10 mm

79179

AUSGLEICHSPROFIL 2-teilig, gebohrt
Level-adapting profile - 2-part, drilled
 höhenverstellbar / height adjustable 3,9-7,6 mm

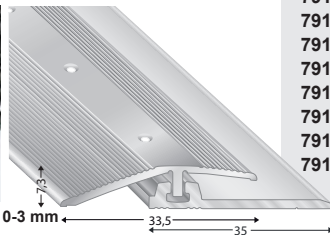

Artikel-Nr. article-no.	Farbe colour	VE unit
79179 20	silber/silver	10
79179 20 100		10
79179 25	sand/sand	10
79179 25 100		10
79179 30	gold/gold	10
79179 30 100		10
79179 40	bronze/bronze	10
79179 40 100		10
79179 15	titan/EO	10
79179 15 100		10

Preis/Stange price/piece		Preis/Stück price/piece	
270 cm	270 cm	100 cm	100 cm
Lagerware	Bestellware	Lagerware	Bestellware
48,36		18,48	
51,56		19,73	
	*		*
53,21		20,38	

max. schwenkbar niedrige Position 0-3 mm
 max. swiveling lowest position 0-3 mm
 max. schwenkbar höchste Position 0-9 mm
 max. swiveling highest position 0-9 mm

* Preis auf Anfrage / price on request



CONFIGO

2-teiliges Klemmsystem aus Aluminium
höhenverstellbar

*2-part clip system in aluminium
height adjustable*

CONFIGO

CONFIGO 2-teiliges Klemmsystem für LVT und Designbeläge höhenverstellbar von 3,6 - 7 mm

SET inkl. Schrauben und Dübel, erhältlich in den Längen: 1 m und 2,70 m

CONFIGO 2-part clip system for LVT and design floorings height adjustable from 3,6 - 7 mm

Set incl. screws and dowels, available in lengths of 1 m and 2,70 m

CFG 221

ABSCHLUSSPROFIL 2-teilig

End profile - 2-part

höhenverstellbar / height adjustable 3,6-7 mm

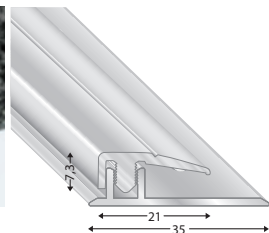

Artikel-Nr. article-no.	Farbe colour	VE unit
CFG221 S	silber/silver	10
CFG221 S 100		10
CFG221 SD	sand/sand	10
CFG221 SD100		10
CFG221 G	gold/gold	10
CFG221 G 100		10
CFG221 B	bronze/bronze	10
CFG221 B 100		10
CFG221 EO	titan/EO	10
CFG221 EO100		10

Preis/Stange price/piece		Preis/Stück price/piece	
270 cm	270 cm	100 cm	100 cm
Lagerware	Bestellware	Lagerware	Bestellware
36,80		16,28	
	*		*
	*		*
	*		*
	*		*
	*		*

CFG 230

ÜBERGANGSPROFIL 2-teilig

Joining profile - 2-part

höhenverstellbar / height adjustable 3,6-7 mm

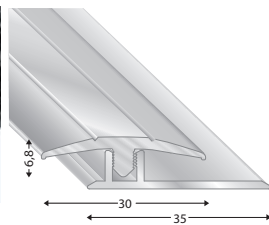

Artikel-Nr. article-no.	Farbe colour	VE unit
CFG230 S	silber/silver	10
CFG230 S 100		10
CFG230 SD	sand/sand	10
CFG230 SD100		10
CFG230 G	gold/gold	10
CFG230 G 100		10
CFG230 B	bronze/bronze	10
CFG230 B 100		10
CFG230 EO	titan/EO	10
CFG230 EO100		10

Preis/Stange price/piece		Preis/Stück price/piece	
270 cm	270 cm	100 cm	100 cm
Lagerware	Bestellware	Lagerware	Bestellware
38,58		16,97	
	*		*
	*		*
	*		*
	*		*
	*		*

CFG 233

AUSGLEICHSPROFIL 2-teilig

Level-adapting profile - 2-part

höhenverstellbar / height adjustable 3,6-7 mm

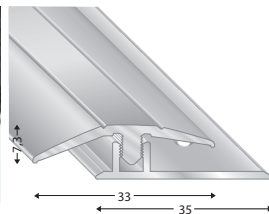

Artikel-Nr. article-no.	Farbe colour	VE unit
CFG233 S	silber/silver	10
CFG233 S 100		10
CFG233 SD	sand/sand	10
CFG233 SD100		10
CFG233 G	gold/gold	10
CFG233 G 100		10
CFG233 B	bronze/bronze	10
CFG233 B 100		10
CFG233 EO	titan/EO	10
CFG233 EO100		10

Preis/Stange price/piece		Preis/Stück price/piece	
270 cm	270 cm	100 cm	100 cm
Lagerware	Bestellware	Lagerware	Bestellware
40,57		17,87	
	*		*
	*		*
	*		*
	*		*
	*		*

CFG 625

TREPPENKANTENPROFIL 2-teilig

Stair nosing profile - 2-part

höhenverstellbar / height adjustable 3,6-7 mm

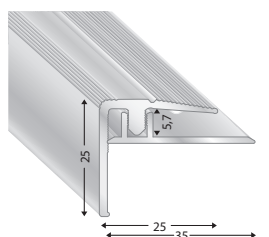

Artikel-Nr. article-no.	Farbe colour	VE unit
CFG625 S	silber/silver	5

Preis/Stange price/piece		Preis/Stück price/piece	
270 cm	270 cm	100 cm	100 cm
Lagerware	Bestellware	Lagerware	Bestellware
		52,10	

* Preis auf Anfrage / price on request



WINKELPROFILE

aus Aluminium

ANGLE PROFILES

in aluminium

3A

1105 A
WINKELPROFIL, gebohrt
ANGLE PROFILE, drilled
30 x 25 mm

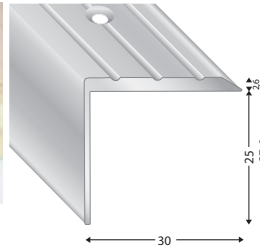
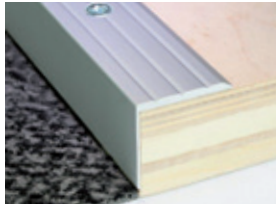

Artikel-Nr. article-no.	Farbe colour	VE unit
1105 A S	silber/silver	S
1105 A S 100		10
1105 A SD	sand/sand	SD
1105 A SD 100		10
1105 A G	gold/gold	G
1105 A G 100		10
1105 A B	bronze/bronze	B
1105 A B 100		10
1105 A EO	titan/EO	titan
1105 A EO 100		10

Preis/Stange price/piece		Preis/Stück price/piece	
270 cm	270 cm	100 cm	100 cm
Lagerware	Bestellware	Lagerware	Bestellware
23,87		10,24	
26,58		11,12	
	*		*
	*		*
	*		*
	*		*

1105 A UNG
WINKELPROFIL, ungebohrt
ANGLE PROFILE, undrilled
30 x 25 mm

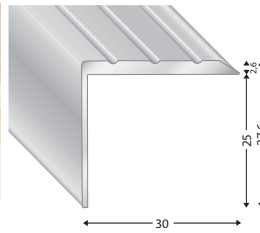

Artikel-Nr. article-no.	Farbe colour	VE unit
1105 A S UNG	silber/silver	S
1105 A S 100 UNG		10
1105 A SD UNG	sand/sand	SD
1105 A SD 100 UNG		10
1105 A G UNG	gold/gold	G
1105 A G 100 UNG		10
1105 A B UNG	bronze/bronze	B
1105 A B 100 UNG		10
1105 A EO UNG	titan/EO	titan
1105 A EO 100 UNG		10

Preis/Stange price/piece		Preis/Stück price/piece	
270 cm	270 cm	100 cm	100 cm
Lagerware	Bestellware	Lagerware	Bestellware
23,87			
26,58			
	*		
	*		
	*		

1105 A SKL
WINKELPROFIL, selbstklebend
ANGLE PROFILE, self-adhesive
30 x 25 mm

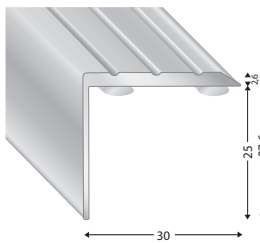

Artikel-Nr. article-no.	Farbe colour	VE unit
1105 A S SKL	silber/silver	S
1105 A S 100 SKL		10
1105 A SD SKL	sand/sand	SD
1105 A SD 100 SKL		10
1105 A G SKL	gold/gold	G
1105 A G 100 SKL		10
1105 A B SKL	bronze/bronze	B
1105 A B 100 SKL		10
1105 A EO SKL	titan/EO	titan
1105 A EO 100 SKL		10

Preis/Stange price/piece		Preis/Stück price/piece	
270 cm	270 cm	100 cm	100 cm
Lagerware	Bestellware	Lagerware	Bestellware
28,44		11,33	
30,14		12,54	
	*		*
	*		*
	*		*

105 A
WINKELPROFIL, gebohrt
ANGLE PROFILE, drilled
25 x 18 mm

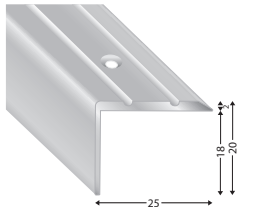
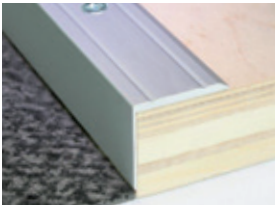

Artikel-Nr. article-no.	Farbe colour	VE unit
105 A S	silber/silver	S
105 A S 100		10
105 A SD	sand/sand	SD
105 A SD 100		10
105 A G	gold/gold	G
105 A G 100		10
105 A B	bronze/bronze	B
105 A B 100		10
105 A EO	titan/EO	titan
105 A EO 100		10

Preis/Stange price/piece		Preis/Stück price/piece	
270 cm	270 cm	100 cm	100 cm
Lagerware	Bestellware	Lagerware	Bestellware
15,07		6,86	
17,60		7,75	
17,60		7,75	
18,91		8,26	
17,95		8,26	

105 A X
WINKELPROFIL, gebohrt, verpackt mit Schrauben
ANGLE PROFILE, drilled, packed with screws
25 x 18 mm

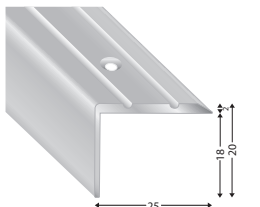

Artikel-Nr. article-no.	Farbe colour	VE unit
105 A S X	silber/silver	S
105 A SD X	sand/sand	SD

Preis/Stange price/piece		Preis/Stück price/piece	
270 cm	270 cm	100 cm	100 cm
Lagerware	Bestellware	Lagerware	Bestellware
18,20			
20,73			

NEU! 270 cm Stangen verpackt mit Schrauben
NEW! 270 cm profiles packed with screws

105 A UNG
WINKELPROFIL, ungebohrt
ANGLE PROFILE, undrilled
25 x 18 mm

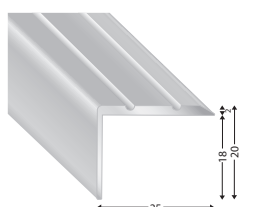

Artikel-Nr. article-no.	Farbe colour	VE unit
105 A S UNG	silber/silver	S
105 A SD UNG	sand/sand	SD
105 A G UNG	gold/gold	G
105 A B UNG	bronze/bronze	B
105 A EO UNG	titan/EO	titan

Preis/Stange price/piece		Preis/Stück price/piece	
270 cm	270 cm	100 cm	100 cm
Lagerware	Bestellware	Lagerware	Bestellware
15,07			
17,60			
17,60			
18,91			
17,95			

* Preis auf Anfrage / price on request

105 A SKL

WINKELPROFIL, selbstklebend
ANGLE PROFILE, self-adhesive
25 x 18 mm

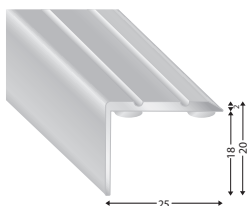

Artikel-Nr. article-no.	Farbe colour	VE unit
105 A S SKL	silber/silver	10
105A S 100 S		10
105 A SD SKL	sand/sand	10
105A SD 100S		10
105 A G SKL	gold/gold	10
105A G 100 S		10
105 A B SKL	bronze/bronze	10
105A B 100 S		10
105 A EO SKL	titan/EO	10
105A EO 100S		10

Preis/Stange price/piece		Preis/Stück price/piece	
270 cm	270 cm	100 cm	100 cm
Lagerware	Bestellware	Lagerware	Bestellware
17,89		8,00	
20,38		8,90	
20,38		8,90	
21,78		9,05	
20,77		9,05	

3A

105 B

WINKELPROFIL, gebohrt
ANGLE PROFILE, drilled
25 x 8 mm

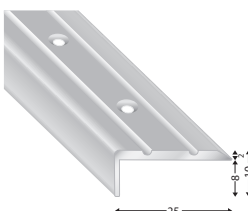

Artikel-Nr. article-no.	Farbe colour	VE unit
105 B S	silber/silver	10
105B S 100		10
105 B SD	sand/sand	10
105B SD 100		10
105 B G	gold/gold	10
105B G 100		10
105 B B	bronze/bronze	10
105B B 100		10
105 B EO	titan/EO	10
105B EO 100		10

Preis/Stange price/piece		Preis/Stück price/piece	
270 cm	270 cm	100 cm	100 cm
Lagerware	Bestellware	Lagerware	Bestellware
14,27		6,56	
16,70		7,46	
16,70		7,46	
17,83		7,90	
16,99		7,61	

105 B X

WINKELPROFIL, gebohrt, verpackt mit Schrauben
ANGLE PROFILE, drilled, packed with screws
25 x 8 mm

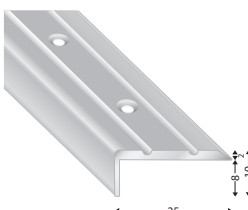

Artikel-Nr. article-no.	Farbe colour	VE unit
105 B S X	silber/silver	10
105 B SD X	sand/sand	10

Preis/Stange price/piece		Preis/Stück price/piece	
270 cm	270 cm	100 cm	100 cm
Lagerware	Bestellware	Lagerware	Bestellware
17,41			
19,83			

NEU! 270 cm Stangen verpackt mit Schrauben
NEW! 270 cm profiles packed with screws

105 B UNG

WINKELPROFIL, ungebohrt
ANGLE PROFILE, undrilled
25 x 8 mm

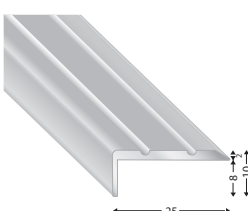

Artikel-Nr. article-no.	Farbe colour	VE unit
105 B S UNGB	silber/silver	10
105 B SD UNG	sand/sand	10
105 B G UNGB	gold/gold	10
105 B B UNGB	bronze/bronze	10
105 B EO UNG	titan/EO	10

Preis/Stange price/piece		Preis/Stück price/piece	
270 cm	270 cm	100 cm	100 cm
Lagerware	Bestellware	Lagerware	Bestellware
14,27			
16,70			
16,70			
17,83			
16,99			

105 B SKL

WINKELPROFIL, selbstklebend
ANGLE PROFILE, self-adhesive
25 x 8 mm

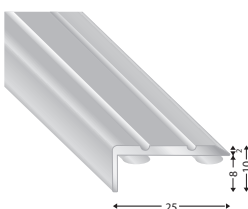

Artikel-Nr. article-no.	Farbe colour	VE unit
105 B S SKL	silber/silver	10
105B S 100S		10
105 B SD SKL	sand/sand	10
105B SD 100S		10
105 B G SKL	gold/gold	10
105B G 100 S		10
105 B B SKL	bronze/bronze	10
105B B 100 S		10
105 B EO SKL	titan/EO	10
105B EO 100S		10

Preis/Stange price/piece		Preis/Stück price/piece	
270 cm	270 cm	100 cm	100 cm
Lagerware	Bestellware	Lagerware	Bestellware
17,03		7,65	
19,52		8,59	
19,52		8,59	
20,61		9,01	
19,86		8,80	

105 C

WINKELPROFIL, gebohrt
ANGLE PROFILE, drilled
 25 x 13 mm



Artikel-Nr. article-no.	Farbe colour	VE unit
105 C S	silber/silver	10
105C S 100		10
105 C SD	sand/sand	10
105C SD 100		10
105 C G	gold/gold	10
105C G 100		10
105 C B	bronze/bronze	10
105C B 100		10
105 C EO	titan/EO	10
105C EO 100		10

Preis/Stange price/piece		Preis/Stück price/piece	
270 cm	270 cm	100 cm	100 cm
Lagerware	Bestellware	Lagerware	Bestellware
16,09		7,32	
18,85		8,26	
	*		*
	*		*
	*		*

105 C UNG

WINKELPROFIL, ungebohrt
ANGLE PROFILE, undrilled
 25 x 13 mm



Artikel-Nr. article-no.	Farbe colour	VE unit
105 C S UNGB	silber/silver	10
105C S 100B		10
105 C SD UNG	sand/sand	10
105C SD 100B		10
105 C G UNGB	gold/gold	10
105C G 100B		10
105 C B UNGB	bronze/bronze	10
105C B 100B		10
105 C EO UNG	titan/EO	10
105C EO 100B		10

Preis/Stange price/piece		Preis/Stück price/piece	
270 cm	270 cm	100 cm	100 cm
Lagerware	Bestellware	Lagerware	Bestellware
16,09			
18,85			
	*		*
	*		*
	*		*

105 C SKL

WINKELPROFIL, selbstklebend
ANGLE PROFILE, self-adhesive
 25 x 13 mm



Artikel-Nr. article-no.	Farbe colour	VE unit
105 C S SKL	silber/silver	10
105C S 100S		10
105 C SD SKL	sand/sand	10
105C SD 100S		10
105 C G SKL	gold/gold	10
105C G 100 S		10
105 C B SKL	bronze/bronze	10
105C B 100 S		10
105 C EO SKL	titan/EO	10
105C EO 100S		10

Preis/Stange price/piece		Preis/Stück price/piece	
270 cm	270 cm	100 cm	100 cm
Lagerware	Bestellware	Lagerware	Bestellware
18,91		8,34	
21,74		9,38	
	*		*
	*		*
	*		*

3515 DL

WINKELPROFIL, gebohrt
ANGLE PROFILE, drilled
 35 x 12,5 mm

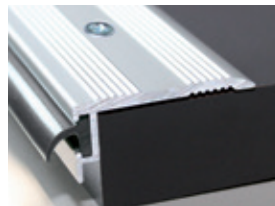

Artikel-Nr. article-no.	Farbe colour	VE unit
3515 DL S	silber/silver	10

Preis/Stange price/piece		Preis/Stück price/piece	
300 cm	300 cm	100 cm	100 cm
Lagerware	Bestellware	Lagerware	Bestellware
26,84			

DL 810 Dichtlippe in grau und schwarz siehe auf Seite 76
 DL 810 Sealing-lip in grey and black see on page 76

3515 DL UNG

WINKELPROFIL, ungebohrt
ANGLE PROFILE, undrilled
 35 x 12,5 mm

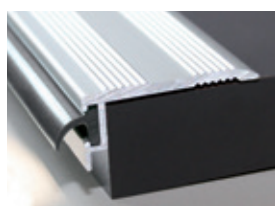

Artikel-Nr. article-no.	Farbe colour	VE unit
3515 DL S U	silber/silver	10

Preis/Stange price/piece		Preis/Stück price/piece	
300 cm	300 cm	100 cm	100 cm
Lagerware	Bestellware	Lagerware	Bestellware
24,89			

DL 810 Dichtlippe in grau und schwarz siehe auf Seite 76
 DL 810 Sealing-lip in grey and black see on page 76

* Preis auf Anfrage / price on request

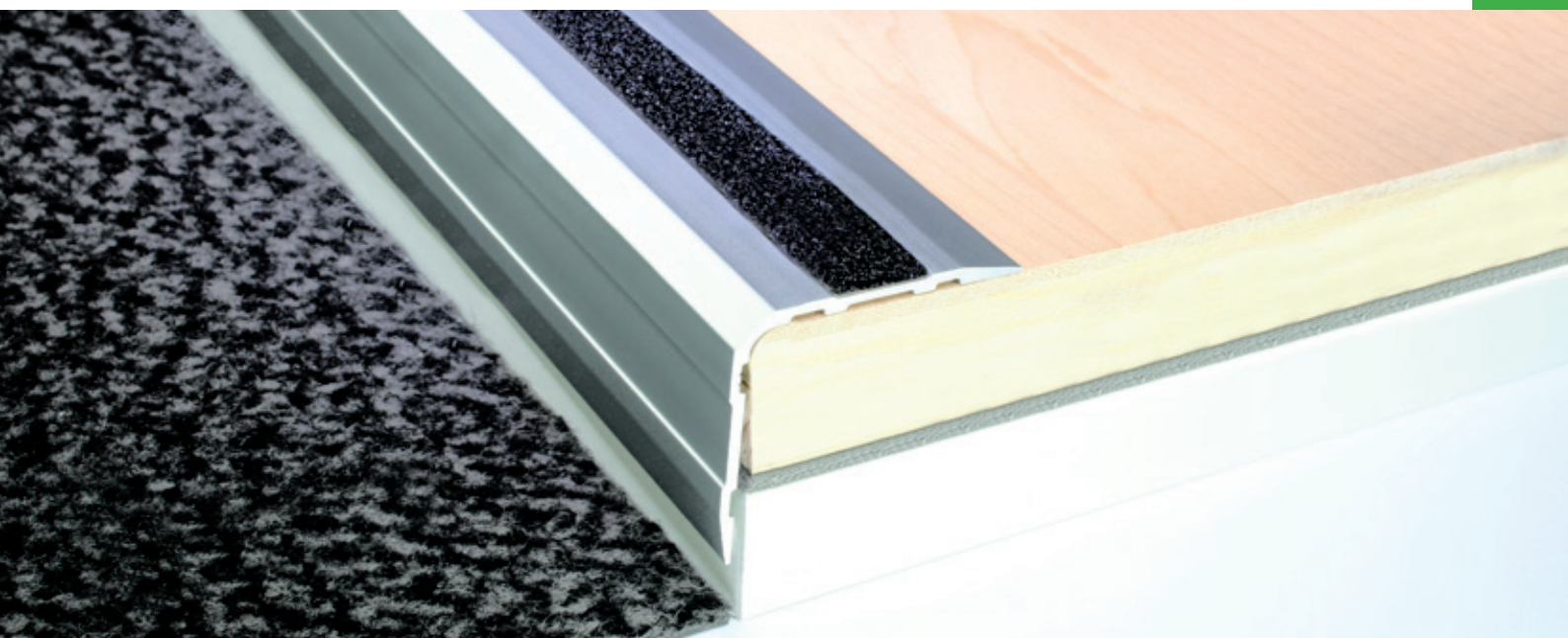

TREPPENKANTEN

aus Aluminium

STAIR NOSINGS

in aluminium

110 A

TREPPENKANTE, versenkt gebohrt, ohne Einlagestreifen - Art. 12, 20114,
STAIR NOSING, countersunk drilled, without insert strip - Art. 12, 20114
39 x 10 mm

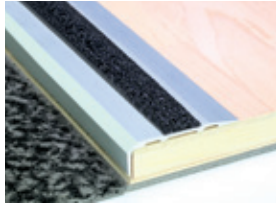

EINLAGESTREIFEN.....Seite 75
INSERT STRIPpage 75

Artikel-Nr. article-no.	Farbe colour	VE unit
110 A S	silber/silver	10

Preis/Stange price/piece	
270 cm	270 cm
Lagerware	Bestellware
19,58	

110 B

TREPPENKANTE, versenkt gebohrt, ohne Einlagestreifen - Art. 1225
STAIR NOSING, countersunk drilled, without insert strip - Art. 1225
51 x 27 mm



EINLAGESTREIFEN.....Seite 75
INSERT STRIPpage 75

Artikel-Nr. article-no.	Farbe colour	VE unit
110 B S	silber/silver	10

Preis/Stange price/piece	
270 cm	270 cm
Lagerware	Bestellware
36,18	

1103

TREPPENKANTE, ungebohrt, ohne Einlagestreifen - Art. 12, 20114
STAIR NOSING, undrilled, without insert strip - Art. 12, 20114
39,1 x 37,1 mm

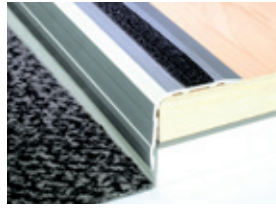

EINLAGESTREIFEN.....Seite 75
INSERT STRIPpage 75

Artikel-Nr. article-no.	Farbe colour	VE unit
1103 S	silber/silver	10

Preis/Stange price/piece	
300 cm	300 cm
Lagerware	Bestellware
26,27	

3101

TREPPENKANTE, gebohrt
STAIR NOSING, drilled
42,5 x 20 mm

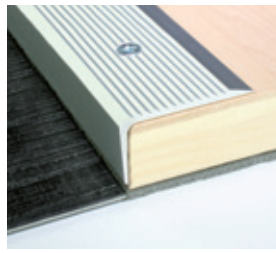

Artikel-Nr. article-no.	Farbe colour	VE unit
3101 S	silber/silver	10

Preis/Stange price/piece	
270 cm	270 cm
Lagerware	Bestellware
32,73	

3101 UNGB

TREPPENKANTE, ungebohrt
STAIR NOSING, undrilled
42,5 x 20 mm

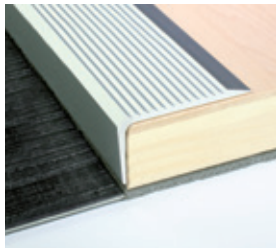

Artikel-Nr. article-no.	Farbe colour	VE unit
3101 S UNGB	silber/silver	10

Preis/Stange price/piece	
270 cm	270 cm
Lagerware	Bestellware
31,27	

3B

3102 GEB

TREPPENKANTE, gebohrt
STAIR NOSING, drilled
42,5 x 25 mm

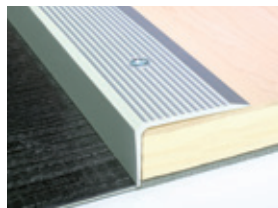

Artikel-Nr. article-no.	Farbe colour	VE unit
3102 S GEB	silber/silver	10

Preis/Stange price/piece	
270 cm	270 cm
Lagerware	Bestellware
35,09	

3102 UNGB

TREPPENKANTE, ungebohrt
STAIR NOSING, undrilled
42,5 x 25 mm

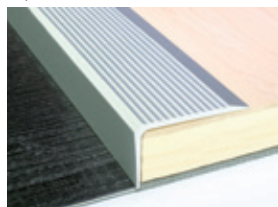

Artikel-Nr. article-no.	Farbe colour	VE unit
3102 S	silber/silver	10

Preis/Stange price/piece	
270 cm	270 cm
Lagerware	Bestellware
35,09	

3105

TREPPENKANTE, gebohrt
STAIR NOSING, drilled
42,5 x 30 mm



Artikel-Nr. article-no.	Farbe colour	VE unit
3105 S	silber/silver	10
3105 SD	sand/sand	10
3105 G	gold/gold	10
3105 B	bronze/bronze	10
3105 EO	titan/EO	10

Preis/Stange price/piece	
270 cm	270 cm
Lagerware	Bestellware
30,93	
32,83	
32,83	
38,10	
33,52	

3105 UNGB

TREPPENKANTE, ungebohrt
STAIR NOSING, undrilled
42,5 x 30 mm



Artikel-Nr. article-no.	Farbe colour	VE unit
3105 S UNGB	silber/silver	10
3105 SD UNGB	sand/sand	10
3105 G UNGB	gold/gold	10
3105 B UNGB	bronze/bronze	10
3105 EO UNGB	titan/EO	10

Preis/Stange price/piece	
270 cm	270 cm
Lagerware	Bestellware
30,93	
32,83	
32,83	
38,10	
33,52	

3108

TREPPENKANTE, gebohrt
STAIR NOSING, drilled
42,5 x 42 mm

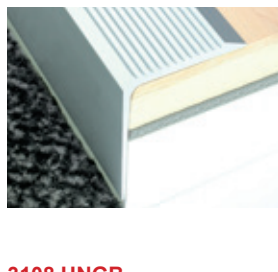

Artikel-Nr. article-no.	Farbe colour	VE unit
3108 S	silber/silver	10

Preis/Stange price/piece	
270 cm	270 cm
Lagerware	Bestellware
31,83	

3108 UNGB

TREPPENKANTE, ungebohrt
STAIR NOSING, undrilled
42,5 x 42 mm

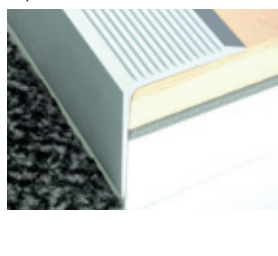

Artikel-Nr. article-no.	Farbe colour	VE unit
3108 S UNGB	silber/silver	10

Preis/Stange price/piece	
270 cm	270 cm
Lagerware	Bestellware
31,83	

3B

MONOPROFILE

3103

TREPPENKANTE, gebohrt
STAIR NOSING, drilled
 42,5 x 63 mm

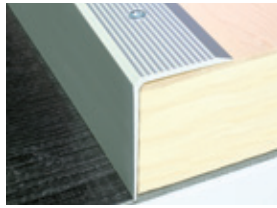

3103 S	silber/silver	S	10
---------------	---------------	---	----

Preis/Stange price/piece	
270 cm	270 cm
Lagerware	Bestellware
49,39	

3103 UNGB

TREPPENKANTE, ungebohrt
STAIR NOSING, undrilled
 42,5 x 63 mm

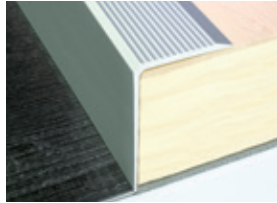

3103 S UNGB	silber/silver	S	10
--------------------	---------------	---	----

Preis/Stange price/piece	
270 cm	270 cm
Lagerware	Bestellware
49,39	

3106

TREPPENKANTE, versenkt gebohrt, ohne Einlagestreifen - Art. 50 ST
STAIR NOSING, countersunk drilled, without insert strip - Art. 50 ST
 70 x 22,5 mm



3106 S	silber/silver	S	10
---------------	---------------	---	----

Preis/Stange price/piece	
270 cm	270 cm
Lagerware	Bestellware
46,44	

EINLAGESTREIFEN.....Seite 76
 INSERT STRIPpage 76

3107

TREPPENKANTE, versenkt gebohrt, ohne Einlagestreifen - Art. 50 ST
STAIR NOSING, countersunk drilled, without insert strip - Art. 50 ST
 73 x 44,5 mm



3107 S	silber/silver	S	10
---------------	---------------	---	----

Preis/Stange price/piece	
270 cm	270 cm
Lagerware	Bestellware
53,55	

EINLAGESTREIFEN.....Seite 76
 INSERT STRIPpage 76

703 A

TREPPENKANTE, versenkt gebohrt, ohne Einlagestreifen - Art. 27 E
STAIR NOSING, countersunk drilled, without insert strip - Art. 27 E
 51,5 x 28,5 mm



703 A S	silber/silver	S	10
----------------	---------------	---	----

Preis/Stange price/piece	
270 cm	270 cm
Lagerware	Bestellware
33,96	

EINLAGESTREIFEN.....Seite 76
 INSERT STRIPpage 76

101

TREPPENKANTE, versenkt gebohrt, ohne Einlagestreifen - Art. 27 E
STAIR NOSING, countersunk drilled, without insert strip - Art. 27 E
 42 x 13 mm



101 S	silber/silver	S	10
--------------	---------------	---	----

Preis/Stange price/piece	
270 cm	270 cm
Lagerware	Bestellware
25,56	

EINLAGESTREIFEN.....Seite 76
 INSERT STRIPpage 76

3B

109
TREPPENKANTE, gebohrt
 STAIR NOSING, drilled
 48 x 21,6 mm

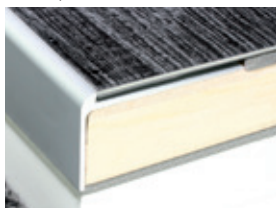

Innenhöhe / inner-height 2,8 mm

Artikel-Nr. article-no.	Farbe colour	VE unit
109 S	silber/silver	10

Preis/Stange price/piece	
270 cm	270 cm
Lagerware	Bestellware
28,61	

109 3A
TREPPENKANTE, gebohrt
 STAIR NOSING, drilled
 48 x 8,2 mm



Innenhöhe / inner-height 3 mm

Artikel-Nr. article-no.	Farbe colour	VE unit
109 3A S	silber/silver	10

Preis/Stange price/piece	
270 cm	270 cm
Lagerware	Bestellware
29,85	

109 3B
TREPPENKANTE, gebohrt
 STAIR NOSING, drilled
 40 x 33,2 mm



Innenhöhe / inner-height 2,8 mm

Artikel-Nr. article-no.	Farbe colour	VE unit
109 3B S	silber/silver	10

Preis/Stange price/piece	
270 cm	270 cm
Lagerware	Bestellware
35,45	

109 21
TREPPENKANTE, gebohrt
 STAIR NOSING, drilled
 37 x 27 mm



Innenhöhe / inner-height 2,1 mm

Artikel-Nr. article-no.	Farbe colour	VE unit
109 21 S	silber/silver	10

Preis/Stange price/piece	
270 cm	270 cm
Lagerware	Bestellware
27,38	

109 26
TREPPENKANTE, gebohrt
 STAIR NOSING, drilled
 37 x 27 mm



Innenhöhe / inner-height 2,6 mm

Artikel-Nr. article-no.	Farbe colour	VE unit
109 26 S	silber/silver	10

Preis/Stange price/piece	
270 cm	270 cm
Lagerware	Bestellware
27,99	

109 30
TREPPENKANTE, gebohrt
 STAIR NOSING, drilled
 37 x 27 mm

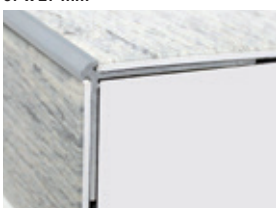

Innenhöhe / inner-height 3 mm

Artikel-Nr. article-no.	Farbe colour	VE unit
109 30 S	silber/silver	10

Preis/Stange price/piece	
270 cm	270 cm
Lagerware	Bestellware
29,01	

3B

109 55

TREPPENKANTE, gebohrt
STAIR NOSING, drilled
 37 x 27 mm



Innenhöhe / inner-height 5,5 mm

Artikel-Nr. article-no.	Farbe colour	VE unit
109 55 S	silber/silver	10

Preis/Stange price/piece	
270 cm	270 cm
Lagerware	Bestellware
34,49	

3B

IW25253

TREPPENKANTE-INNENWINKEL, gebohrt
STAIR NOSING-INNER CORNER drilled
 Höhe bis / heights up to 3 mm

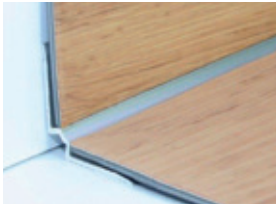

Innenhöhe / inner-height 3 mm

Artikel-Nr. article-no.	Farbe colour	VE unit
IW25253 S	silber/silver	10

Preis/Stange price/piece	
270 cm	270 cm
Lagerware	Bestellware
46,54	

IW25255

TREPPENKANTE-INNENWINKEL, gebohrt
STAIR NOSING-INNER CORNER drilled
 Höhe bis / heights up to 5mm

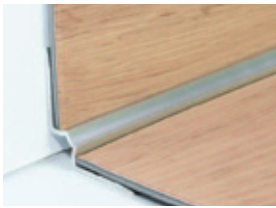

Innenhöhe / inner-height 5 mm

Artikel-Nr. article-no.	Farbe colour	VE unit
IW25255 S	silber/silver	10

Preis/Stange price/piece	
270 cm	270 cm
Lagerware	Bestellware
48,48	

108 D

TREPPENKANTE, gebohrt
STAIR NOSING, drilled
 30 x 6 mm

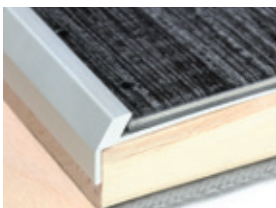

Innenhöhe / inner-height 2,2 mm

Artikel-Nr. article-no.	Farbe colour	VE unit
108 D S	silber/silver	10
108 D G	gold/gold	10
108 D B	bronze/bronze	10

Preis/Stange price/piece	
270 cm	270 cm
Lagerware	Bestellware
13,48	
	*
	*

108 E

TREPPENKANTE, gebohrt
STAIR NOSING, drilled
 30 x 11 mm

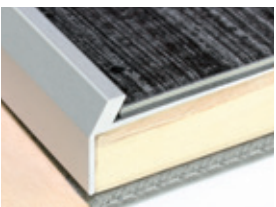

Innenhöhe / inner-height 3 mm

Artikel-Nr. article-no.	Farbe colour	VE unit
108 E S	silber/silver	10
108 E G	gold/gold	10
108 E B	bronze/bronze	10

Preis/Stange price/piece	
270 cm	270 cm
Lagerware	Bestellware
14,57	
	*
	*

* Preis auf Anfrage / price on request

108 M

TREPPENKANTE, gebohrt
STAIR NOSING, drilled
28 x 6 mm

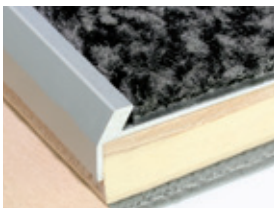

Innenhöhe / inner-height 3,7 mm

Artikel-Nr. article-no.	Farbe colour	VE unit
108 M S	silber/silver	10
108 M SD	sand/sand	10
108 M G	gold/gold	10
108 M B	bronze/bronze	10

Preis/Stange price/piece	
270 cm	270 cm
Lagerware	Bestellware
14,21	*

3B

108 P

TREPPENKANTE, gebohrt
STAIR NOSING, drilled
30 x 10 mm

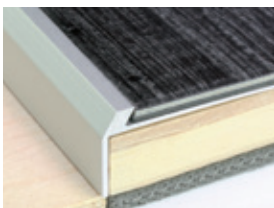

Innenhöhe / inner-height 4 mm

Artikel-Nr. article-no.	Farbe colour	VE unit
108 P S	silber/silver	10

Preis/Stange price/piece	
270 cm	270 cm
Lagerware	Bestellware
14,57	

112

TREPPENKANTE, gebohrt
STAIR NOSING, drilled
30 x 10 mm

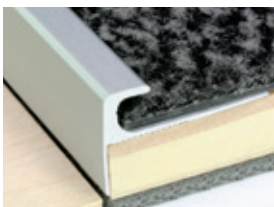

Innenhöhe / inner-height 6,75 mm

Artikel-Nr. article-no.	Farbe colour	VE unit
112 S	silber/silver	10
112 SD	sand/sand	10
112 G	gold/gold	10
112 B	bronze/bronze	10

Preis/Stange price/piece	
270 cm	270 cm
Lagerware	Bestellware
17,79	*

113

TREPPENKANTE, gebohrt
STAIR NOSING, drilled
28 x 6,7 mm



Innenhöhe / inner-height 4,5 mm

Artikel-Nr. article-no.	Farbe colour	VE unit
113 S	silber/silver	10
113 SD	sand/sand	10
113 G	gold/gold	10
113 B	bronze/bronze	10

Preis/Stange price/piece	
270 cm	270 cm
Lagerware	Bestellware
17,16	*

113 A

TREPPENKANTE, gebohrt
STAIR NOSING, drilled
28 x 15 mm

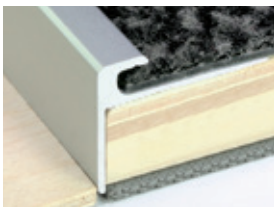

Innenhöhe / inner-height 4,5 mm

Artikel-Nr. article-no.	Farbe colour	VE unit
113 A S	silber/silver	10
113 A SD	sand/sand	10
113 A G	gold/gold	10
113 A B	bronze/bronze	10

Preis/Stange price/piece	
270 cm	270 cm
Lagerware	Bestellware
18,62	*

113 B

TREPPENKANTE, gebohrt
STAIR NOSING, drilled
30 x 9 mm

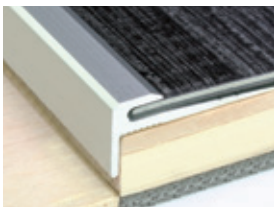

Innenhöhe / inner-height 2,5 mm

Artikel-Nr. article-no.	Farbe colour	VE unit
113 B S	silber/silver	10
113 B SD	sand/sand	10
113 B G	gold/gold	10
113 B B	bronze/bronze	10

Preis/Stange price/piece	
270 cm	270 cm
Lagerware	Bestellware
17,16	*

* Preis auf Anfrage / price on request

113 C
TREPPENKANTE, gebohrt
 STAIR NOSING, drilled
 28 x 6,7 mm



Innenhöhe / inner-height 5 mm

Artikel-Nr. article-no.	Farbe colour	VE unit
113 C S	silber/silver	10
113 C SD	sand/sand	10
113 C G	gold/gold	10
113 C B	bronze/bronze	10

Preis/Stange price/piece	
270 cm	270 cm
Lagerware	Bestellware
18,22	*

113 D
TREPPENKANTE, gebohrt
 STAIR NOSING, drilled
 28 x 15 mm



Innenhöhe / inner-height 5 mm

Artikel-Nr. article-no.	Farbe colour	VE unit
113 D S	silber/silver	10
113 D SD	sand/sand	10
113 D G	gold/gold	10
113 D B	bronze/bronze	10

Preis/Stange price/piece	
270 cm	270 cm
Lagerware	Bestellware
20,15	*

111
TREPPENKANTE, gebohrt
 STAIR NOSING, drilled
 40 x 10,2 mm



Innenhöhe / inner-height 6,5 mm

Artikel-Nr. article-no.	Farbe colour	VE unit
111 S	silber/silver	10
111 G	gold/gold	10
111 B	bronze/bronze	10

Preis/Stange price/piece	
270 cm	270 cm
Lagerware	Bestellware
23,37	*

111 A
TREPPENKANTE, gebohrt
 STAIR NOSING, drilled
 35 x 7 mm



Innenhöhe / inner-height 4,2 mm

Artikel-Nr. article-no.	Farbe colour	VE unit
111 A S	silber/silver	10
111 A G	gold/gold	10
111 A B	bronze/bronze	10

Preis/Stange price/piece	
270 cm	270 cm
Lagerware	Bestellware
17,89	*

111 B
TREPPENKANTE, gebohrt
 STAIR NOSING, drilled
 47 x 7 mm



Innenhöhe / inner-height 4,2 mm

Artikel-Nr. article-no.	Farbe colour	VE unit
111 B S	silber/silver	10
111 B G	gold/gold	10

Preis/Stange price/piece	
270 cm	270 cm
Lagerware	Bestellware
24,49	*

111 C
TREPPENKANTE, gebohrt
 STAIR NOSING, drilled
 35 x 7 mm



Innenhöhe / inner-height 5 mm

Artikel-Nr. article-no.	Farbe colour	VE unit
111 C S	silber/silver	10
111 C G	gold/gold	10
111 C B	bronze/bronze	10

Preis/Stange price/piece	
270 cm	270 cm
Lagerware	Bestellware
19,12	*

* Preis auf Anfrage / price on request

15070

TREPPENKANTE, gebohrt
STAIR NOSING, drilled
Höhe bis / heights up to 7,1 mm

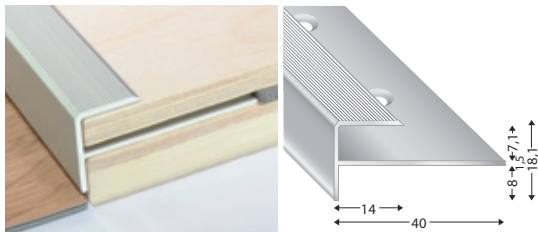

Artikel-Nr. article-no.	Farbe colour	VE unit
15070 S	silber/silver	10
15070 SD	sand/sand	10
15070 G	gold/gold	10
15070 B	bronze/bronze	10
15070 EO	titan/EO	10

Preis/Stange price/piece	
270 cm	270 cm
Lagerware	Bestellware
23,43	*

3B

15080

TREPPENKANTE, gebohrt
STAIR NOSING, drilled
Höhe bis / heights up to 8,1 mm

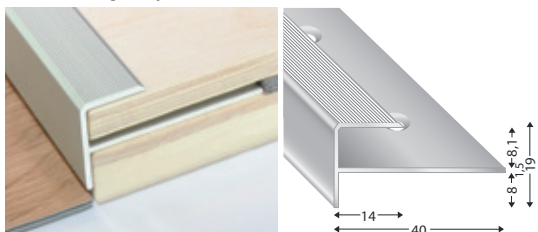

Artikel-Nr. article-no.	Farbe colour	VE unit
15080 S	silber/silver	10
15080 SD	sand/sand	10
15080 G	gold/gold	10
15080 B	bronze/bronze	10
15080 EO	titan/EO	10

Preis/Stange price/piece	
270 cm	270 cm
Lagerware	Bestellware
24,04	*

15110

TREPPENKANTE, gebohrt
STAIR NOSING, drilled
Höhe bis / heights up to 11,1 mm

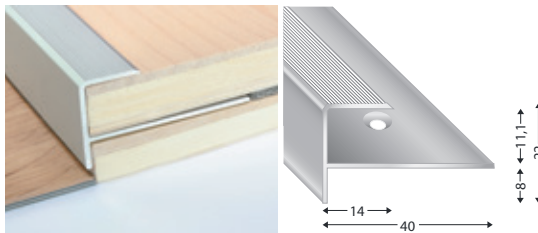

Artikel-Nr. article-no.	Farbe colour	VE unit
15110 S	silber/silver	10
15110 SD	sand/sand	10
15110 G	gold/gold	10
15110 B	bronze/bronze	10
15110 EO	titan/EO	10

Preis/Stange price/piece	
270 cm	270 cm
Lagerware	Bestellware
24,56	*

15150

TREPPENKANTE, gebohrt
STAIR NOSING, drilled
Höhe bis / heights up to 15,1 mm

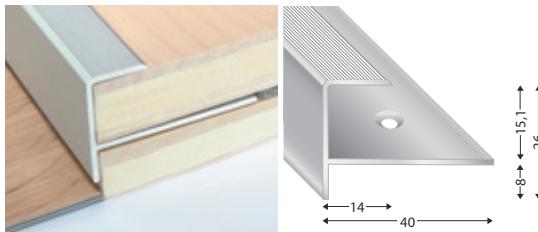

Artikel-Nr. article-no.	Farbe colour	VE unit
15150 S	silber/silver	10
15150 SD	sand/sand	10
15150 G	gold/gold	10
15150 B	bronze/bronze	10
15150 EO	titan/EO	10

Preis/Stange price/piece	
270 cm	270 cm
Lagerware	Bestellware
25,12	*

* Preis auf Anfrage / price on request



ABSCHLUSSPROFILE

aus Aluminium

END PROFILES

in aluminium

11055
ABSCHLUSSPROFIL, ungebohrt
END PROFILE, undrilled
 Höhen / heights 5,5 mm

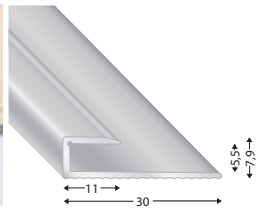
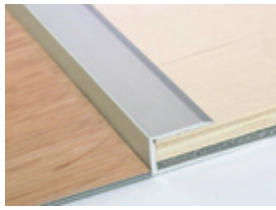

Artikel-Nr. article-no.	Farbe colour	VE unit
11055 S	silber/silver	10
11055 S 100	silber/silver	10
11055 SD	sand/sand	10
11055 SD 100	sand/sand	10
11055 G	gold/gold	10
11055 G 100	gold/gold	10
11055 B	bronze/bronze	10
11055 B 100	bronze/bronze	10
11055 EO	titan/EO	10
11055 EO 100	titan/EO	10

Preis/Stange price/piece		Preis/Stück price/piece	
270 cm	270 cm	100 cm	100 cm
Lagerware	Bestellware	Lagerware	Bestellware
14,40		5,85	
16,53		6,73	
	*		*
	*		*
	*		*
	*		*
	*		*

11070
ABSCHLUSSPROFIL, ungebohrt
END PROFILE, undrilled
 Höhen / heights 7,1 mm

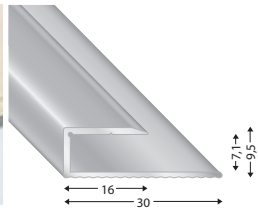

Artikel-Nr. article-no.	Farbe colour	VE unit
11070 S	silber/silver	10
11070 S 100	silber/silver	10
11070 SD	sand/sand	10
11070 SD 100	sand/sand	10
11070 G	gold/gold	10
11070 G 100	gold/gold	10
11070 B	bronze/bronze	10
11070 B 100	bronze/bronze	10
11070 EO	titan/EO	10
11070 EO 100	titan/EO	10

Preis/Stange price/piece		Preis/Stück price/piece	
270 cm	270 cm	100 cm	100 cm
Lagerware	Bestellware	Lagerware	Bestellware
15,01		6,83	
17,26		7,67	
	*		*
	*		*
	*		*
	*		*
	*		*

11080
ABSCHLUSSPROFIL, ungebohrt
END PROFILE, undrilled
 Höhen / heights 8,4 mm

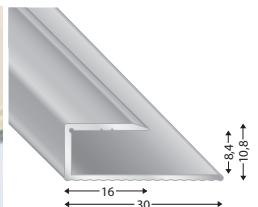

Artikel-Nr. article-no.	Farbe colour	VE unit
11080 S	silber/silver	10
11080 S 100	silber/silver	10
11080 SD	sand/sand	10
11080 SD 100	sand/sand	10
11080 G	gold/gold	10
11080 G 100	gold/gold	10
11080 B	bronze/bronze	10
11080 B 100	bronze/bronze	10
11080 EO	titan/EO	10
11080 EO 100	titan/EO	10

Preis/Stange price/piece		Preis/Stück price/piece	
270 cm	270 cm	100 cm	100 cm
Lagerware	Bestellware	Lagerware	Bestellware
15,24		6,92	
17,79		7,80	
	*		*
	*		*
	*		*
	*		*
	*		*

11100
ABSCHLUSSPROFIL, ungebohrt
END PROFILE, undrilled
 Höhen / heights 10,2 mm

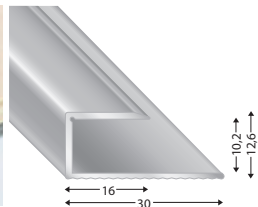

Artikel-Nr. article-no.	Farbe colour	VE unit
11100 S	silber/silver	10
11100 S 100	silber/silver	10
11100 SD	sand/sand	10
11100 SD 100	sand/sand	10
11100 G	gold/gold	10
11100 G 100	gold/gold	10
11100 B	bronze/bronze	10
11100 B 100	bronze/bronze	10
11100 EO	titan/EO	10
11100 EO 100	titan/EO	10

Preis/Stange price/piece		Preis/Stück price/piece	
270 cm	270 cm	100 cm	100 cm
Lagerware	Bestellware	Lagerware	Bestellware
15,47		6,92	
18,06		7,63	
	*		*
	*		*
	*		*
	*		*
	*		*

11110
ABSCHLUSSPROFIL, ungebohrt
END PROFILE, undrilled
 Höhen / heights 11,2 mm

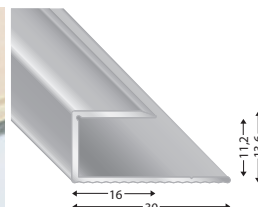

Artikel-Nr. article-no.	Farbe colour	VE unit
11110 S	silber/silver	10
11110 S 100	silber/silver	10
11110 SD	sand/sand	10
11110 SD 100	sand/sand	10
11110 G	gold/gold	10
11110 G 100	gold/gold	10
11110 B	bronze/bronze	10
11110 B 100	bronze/bronze	10
11110 EO	titan/EO	10
11110 EO 100	titan/EO	10

Preis/Stange price/piece		Preis/Stück price/piece	
270 cm	270 cm	100 cm	100 cm
Lagerware	Bestellware	Lagerware	Bestellware
15,47		7,02	
18,06		7,98	
	*		*
	*		*
	*		*
	*		*
	*		*

11120
ABSCHLUSSPROFIL, ungebohrt
END PROFILE, undrilled
 Höhen / heights 12,2 mm

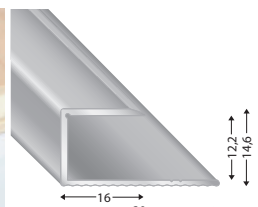

Artikel-Nr. article-no.	Farbe colour	VE unit
11120 S	silber/silver	10
11120 S 100	silber/silver	10
11120 SD	sand/sand	10
11120 SD 100	sand/sand	10
11120 G	gold/gold	10
11120 G 100	gold/gold	10
11120 B	bronze/bronze	10
11120 B 100	bronze/bronze	10

Preis/Stange price/piece		Preis/Stück price/piece	
270 cm	270 cm	100 cm	100 cm
Lagerware	Bestellware	Lagerware	Bestellware
17,60		7,75	
	*		*
	*		*
	*		*
	*		*

* Preis auf Anfrage / price on request



11130
ABSCHLUSSPROFIL, ungebohrt
END PROFILE, undrilled
Höhen / heights 13,2 mm

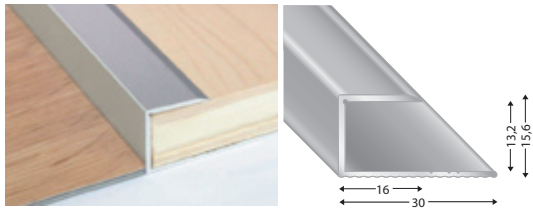

Artikel-Nr. article-no.	Farbe colour	VE unit	Preis/Stange price/piece		Preis/Stück price/piece	
			270 cm	270 cm	100 cm	100 cm
11130 S	silber/silver	10	17,66			
11130 S 100		10			7,75	
11130 SD	sand/sand	10	20,08			
11130 SD 100		10			8,65	
11130 G	gold/gold	10		*		*
11130 G 100		10				*
11130 B	bronze/bronze	10		*		*
11130 B 100		10				*
11130 EO	titan/EO	10		*		*
11130 EO 100		10				*

Preis/Stange price/piece		Preis/Stück price/piece	
270 cm	270 cm	100 cm	100 cm
Lagerware	Bestellware	Lagerware	Bestellware
17,66		7,75	
20,08		8,65	
	*		*
			*
	*		*
			*

11140
ABSCHLUSSPROFIL, ungebohrt
END PROFILE, undrilled
Höhen / heights 14,1 mm

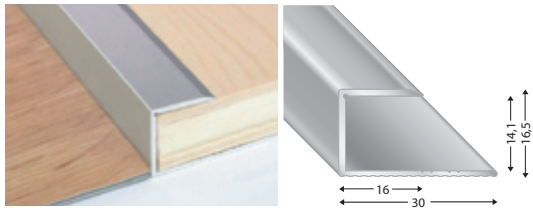

Artikel-Nr. article-no.	Farbe colour	VE unit	Preis/Stange price/piece		Preis/Stück price/piece	
			270 cm	270 cm	100 cm	100 cm
11140 S	silber/silver	10	18,22			
11140 S 100		10			8,07	
11140 SD	sand/sand	10	21,51			
11140 SD 100		10			8,84	
11140 G	gold/gold	10		*		*
11140 G 100		10				*
11140 B	bronze/bronze	10		*		*
11140 B 100		10				*
11140 EO	titan/EO	10		*		*
11140 EO 100		10				*

Preis/Stange price/piece		Preis/Stück price/piece	
270 cm	270 cm	100 cm	100 cm
Lagerware	Bestellware	Lagerware	Bestellware
18,22		8,07	
21,51		8,84	
	*		*
			*
	*		*
			*

11150
ABSCHLUSSPROFIL, ungebohrt
END PROFILE, undrilled
Höhen / heights 15,1 mm

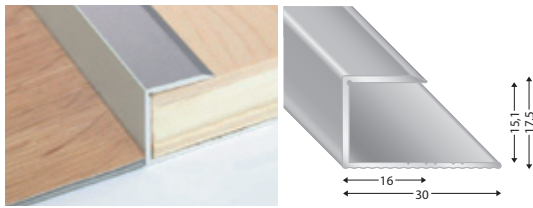

Artikel-Nr. article-no.	Farbe colour	VE unit	Preis/Stange price/piece		Preis/Stück price/piece	
			270 cm	270 cm	100 cm	100 cm
11150 S	silber/silver	10	18,45			
11150 S 100		10			8,15	
11150 SD	sand/sand	10	21,78			
11150 SD 100		10			9,36	
11150 G	gold/gold	10		*		*
11150 G 100		10				*
11150 B	bronze/bronze	10		*		*
11150 B 100		10				*
11150 EO	titan/EO	10		*		*
11150 EO 100		10				*

Preis/Stange price/piece		Preis/Stück price/piece	
270 cm	270 cm	100 cm	100 cm
Lagerware	Bestellware	Lagerware	Bestellware
18,45		8,15	
21,78		9,36	
	*		*
			*
	*		*
			*

11180
ABSCHLUSSPROFIL, ungebohrt
END PROFILE, undrilled
Höhen / heights 18,2 mm

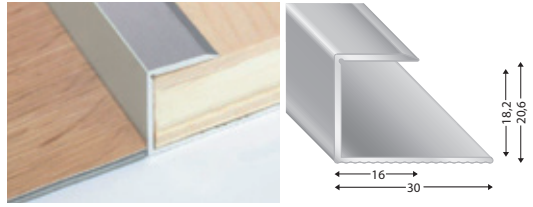

Artikel-Nr. article-no.	Farbe colour	VE unit	Preis/Stange price/piece		Preis/Stück price/piece	
			270 cm	270 cm	100 cm	100 cm
11180 S	silber/silver	10	19,75			
11180 SD	sand/sand	10		*		
11180 G	gold/gold	10		*		
11180 B	bronze/bronze	10		*		

Preis/Stange price/piece		Preis/Stück price/piece	
270 cm	270 cm	100 cm	100 cm
Lagerware	Bestellware	Lagerware	Bestellware
19,75			
	*		
	*		
	*		

11220
ABSCHLUSSPROFIL, ungebohrt
END PROFILE, undrilled
Höhen / heights 22,2 mm

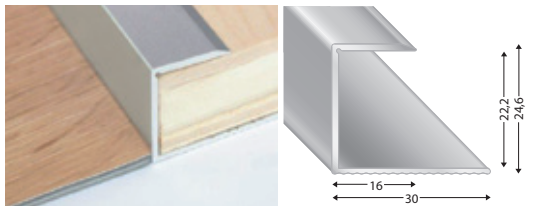

Artikel-Nr. article-no.	Farbe colour	VE unit	Preis/Stange price/piece		Preis/Stück price/piece	
			270 cm	270 cm	100 cm	100 cm
11220 S	silber/silver	10	20,54			
11220 SD	sand/sand	10		*		
11220 G	gold/gold	10		*		
11220 B	bronze/bronze	10		*		

Preis/Stange price/piece		Preis/Stück price/piece	
270 cm	270 cm	100 cm	100 cm
Lagerware	Bestellware	Lagerware	Bestellware
20,54			
	*		
	*		
	*		

* Preis auf Anfrage / price on request

16070
ABSCHLUSSPROFIL, ungebohrt
END PROFILE, undrilled
 16,5 x 5,7 mm

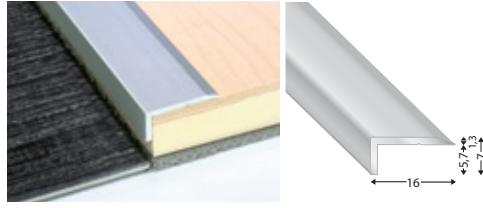

Artikel-Nr. article-no.	Farbe colour	VE unit
16070 S	silber/silver	10
16070 EO	titan/EO	10

Preis/Stange price/piece	
270 cm	270 cm
Lagerware	Bestellware
6,77	
7,00	

16100
ABSCHLUSSPROFIL, ungebohrt
END PROFILE, undrilled
 16 x 8,7 mm

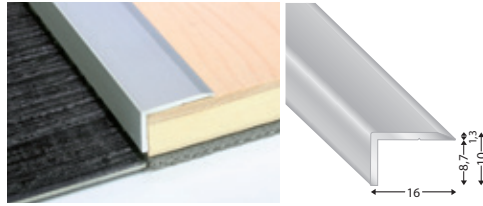

Artikel-Nr. article-no.	Farbe colour	VE unit
16100 S	silber/silver	10
16100 EO	titan/EO	10

Preis/Stange price/piece	
270 cm	270 cm
Lagerware	Bestellware
7,67	
7,96	

16120
ABSCHLUSSPROFIL, ungebohrt
END PROFILE, undrilled
 20 x 8,7 mm

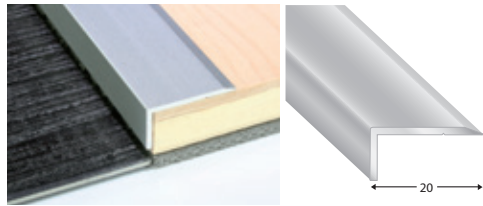

Artikel-Nr. article-no.	Farbe colour	VE unit
16120 S	silber/silver	10
16120 EO	titan/EO	10

Preis/Stange price/piece	
270 cm	270 cm
Lagerware	Bestellware
8,92	
9,20	

114
ABSCHLUSSPROFIL, gebohrt
END PROFILE, drilled
 Höhen bis / heights up to 6,5 mm

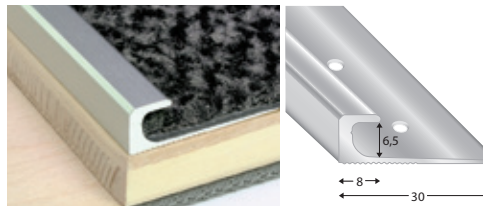

Artikel-Nr. article-no.	Farbe colour	VE unit
114 S	silber/silver	10
114 SD	sand/sand	10
114 G	gold/gold	10
114 B	bronze/bronze	10

Preis/Stange price/piece	
270 cm	270 cm
Lagerware	Bestellware
16,47	
	*
	*
	*

115
ABSCHLUSSPROFIL, gebohrt
END PROFILE, drilled
 Höhen bis / heights up to 4,5 mm

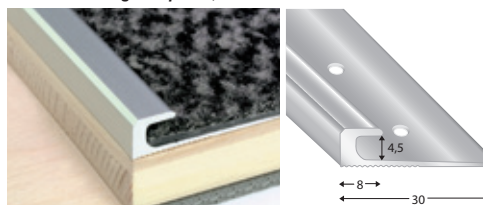

Artikel-Nr. article-no.	Farbe colour	VE unit
115 S	silber/silver	10
115 SD	sand/sand	10
115 G	gold/gold	10
115 B	bronze/bronze	10

Preis/Stange price/piece	
270 cm	270 cm
Lagerware	Bestellware
16,09	
	*
	*
	*

* Preis auf Anfrage / price on request

115 A
ABSCHLUSSPROFIL, gebohrt
END PROFILE, drilled
 Höhen bis / heights up to 5 mm

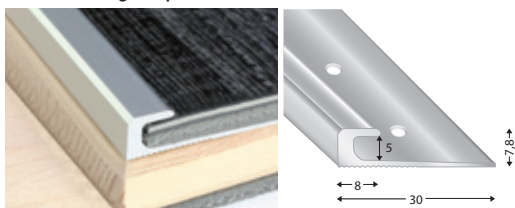

Artikel-Nr. article-no.	Farbe colour	VE unit
115 A S	silber/silver	10
115 A SD	sand/sand	10
115 A G	gold/gold	10
115 A B	bronze/bronze	10

Preis/Stange price/piece	
270 cm	270 cm
Lagerware	Bestellware
16,87	*

115 B
ABSCHLUSSPROFIL, gebohrt
END PROFILE, drilled
 Höhen bis / heights up to 2,5 mm

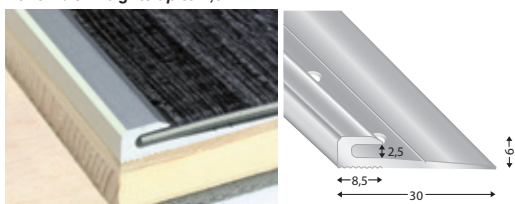

Artikel-Nr. article-no.	Farbe colour	VE unit
115 B S	silber/silver	10
115 B SD	sand/sand	10
115 B G	gold/gold	10
115 B B	bronze/bronze	10

Preis/Stange price/piece	
270 cm	270 cm
Lagerware	Bestellware
15,86	*

108 A
ABSCHLUSSPROFIL, gebohrt - Nase 1 mm
END PROFILE, drilled - nose 1 mm
 Höhen bis / heights up to 5 mm

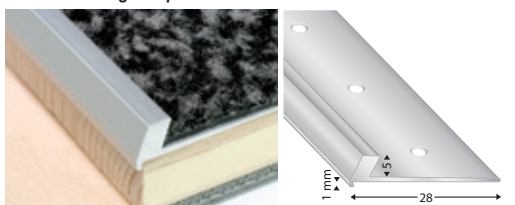

Artikel-Nr. article-no.	Farbe colour	VE unit
108 A S	silber/silver	10
108 A G	gold/gold	10
108 A B	bronze/bronze	10

Preis/Stange price/piece	
270 cm	270 cm
Lagerware	Bestellware
14,90	*

108 B
ABSCHLUSSPROFIL, gebohrt - Nase 1 mm
END PROFILE, drilled - nose 1 mm
 Höhen bis / heights up to 3 mm

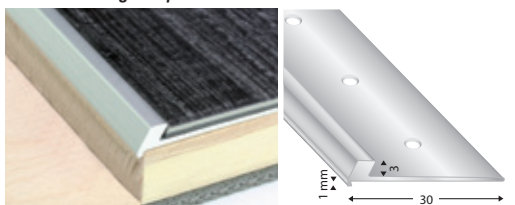

Artikel-Nr. article-no.	Farbe colour	VE unit
108 B S	silber/silver	10
108 B G	gold/gold	10
108 B B	bronze/bronze	10

Preis/Stange price/piece	
270 cm	270 cm
Lagerware	Bestellware
12,75	*

108 C
ABSCHLUSSPROFIL, gebohrt
END PROFILE, drilled
 Höhen bis / heights up to 2,2 mm

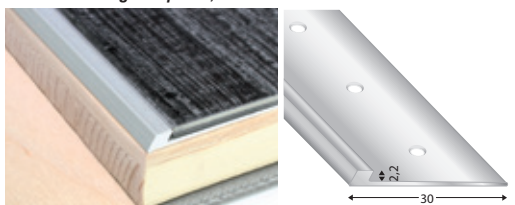

Artikel-Nr. article-no.	Farbe colour	VE unit
108 C S	silber/silver	10
108 C SD	sand/sand	10
108 C G	gold/gold	10
108 C B	bronze/bronze	10

Preis/Stange price/piece	
270 cm	270 cm
Lagerware	Bestellware
12,31	*

108 K
ABSCHLUSSPROFIL, gebohrt
END PROFILE, drilled
 Höhen bis / heights up to 3,7 mm

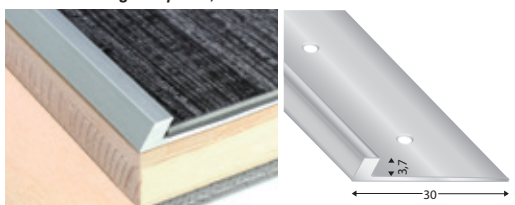

Artikel-Nr. article-no.	Farbe colour	VE unit
108 K S	silber/silver	10
108 K G	gold/gold	10
108 K B	bronze/bronze	10

Preis/Stange price/piece	
270 cm	270 cm
Lagerware	Bestellware
13,15	*

* Preis auf Anfrage / price on request

3C

U-PROFILE

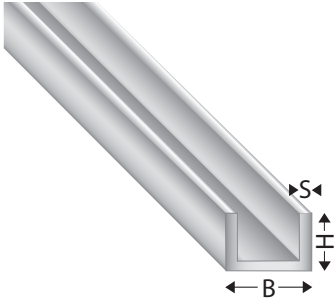

Artikel-Nr. article-no.	Farbe colour	VE unit	Maße size H/B/H/S	Preis/Stange price/piece	
				300 cm Lagerware	300 cm Bestellware
6661 S	silber/silver	s 10	6x6x6x1	3,89	
8881 S	silber/silver	s 10	8x8x8x1	5,08	
1010102 S	silber/silver	s 10	10x10x10x2	11,04	
1212122 S	silber/silver	s 10	12x12x12x2	13,42	
1515152 S	silber/silver	s 10	15x15x15x2	16,99	
2020202 S	silber/silver	s 10	20x20x20x2	22,95	
2525252 S	silber/silver	s 10	25x25x25x2	28,90	
3030302 S	silber/silver	s 10	30x30x30x2	34,84	
4040402 S	silber/silver	s 10	40x40x40x2	46,75	

U-PROFILE

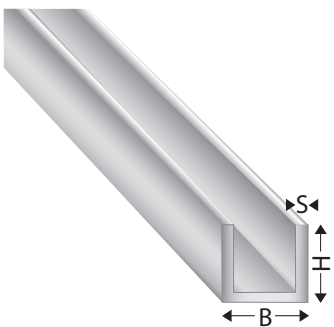

Artikel-Nr. article-no.	Farbe colour	VE unit	Maße size H/B/H/S	Preis/Stange price/piece	
				300 cm Lagerware	300 cm Bestellware
2015201 S	silber/silver	s 10	20x15x20x1,5	16,20	
2017201 S	silber/silver	s 10	20x17x20x1,5	16,53	
1020102 S	silber/silver	s 10	10x20x10x2	15,06	
1520152 S	silber/silver	s 10	15x20x15x2	19,05	
3020302 S	silber/silver	s 10	30x20x30x2	30,87	
4020402 S	silber/silver	s 10	40x20x40x2	38,81	
5020502 S	silber/silver	s 10	50x20x50x2	46,75	
2030202 S	silber/silver	s 10	20x30x20x2	26,92	
2040202 S	silber/silver	s 10	20x40x20x2	30,87	
3050303 S	silber/silver	s 10	30x50x30x3	62,62	

andere Größen auf Anfrage / other measurements on request



ÜBERGANGSPROFILE

aus Aluminium

JOINING PROFILES

in aluminium

12070
ÜBERGANGSPROFIL, ungebohrt
JOINING PROFILE, undrilled
 Innenhöhe / inner height 7,1 mm

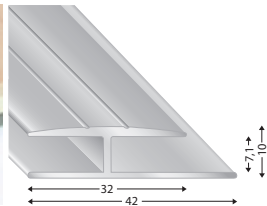

Artikel-Nr. article-no.	Farbe colour	VE unit
12070 S	silber/silver	10
12070 SD	sand/sand	10
12070 G	gold/gold	10
12070 B	bronze/bronze	10

Preis/Stange price/piece	
270 cm	270 cm
Lagerware	Bestellware
25,00	*

12080
ÜBERGANGSPROFIL, ungebohrt
JOINING PROFILE, undrilled
 Innenhöhe / inner height 8,4 mm

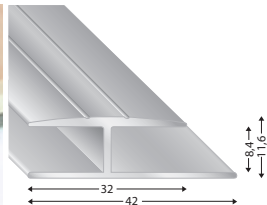

Artikel-Nr. article-no.	Farbe colour	VE unit
12080 S	silber/silver	10
12080 SD	sand/sand	10
12080 G	gold/gold	10
12080 B	bronze/bronze	10

Preis/Stange price/piece	
270 cm	270 cm
Lagerware	Bestellware
26,25	*

12110
ÜBERGANGSPROFIL, ungebohrt
JOINING PROFILE, undrilled
 Innenhöhe / inner height 11,4 mm

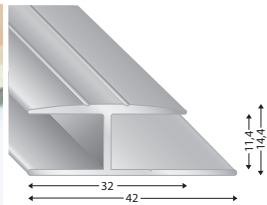

Artikel-Nr. article-no.	Farbe colour	VE unit
12110 S	silber/silver	10
12110 SD	sand/sand	10
12110 G	gold/gold	10
12110 B	bronze/bronze	10

Preis/Stange price/piece	
270 cm	270 cm
Lagerware	Bestellware
26,42	*

12140
ÜBERGANGSPROFIL, ungebohrt
JOINING PROFILE, undrilled
 Innenhöhe / inner height 14,1 mm

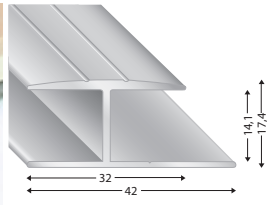

Artikel-Nr. article-no.	Farbe colour	VE unit
12140 S	silber/silver	10
12140 SD	sand/sand	10
12140 G	gold/gold	10
12140 B	bronze/bronze	10

Preis/Stange price/piece	
270 cm	270 cm
Lagerware	Bestellware
27,65	*

12150
ÜBERGANGSPROFIL, ungebohrt
JOINING PROFILE, undrilled
 Innenhöhe / inner height 15,1 mm

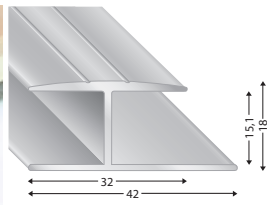

Artikel-Nr. article-no.	Farbe colour	VE unit
12150 S	silber/silver	10
12150 SD	sand/sand	10
12150 G	gold/gold	10
12150 B	bronze/bronze	10

Preis/Stange price/piece	
270 cm	270 cm
Lagerware	Bestellware
28,15	*

* Preis auf Anfrage / price on request

1407
ÜBERGANGSPROFIL, gebohrt
 JOINING PROFILE, drilled
 14 x 7 mm

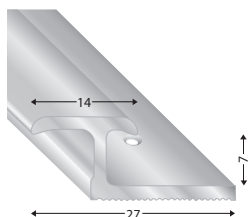

Innenhöhe 7 mm / inner-height 7 mm

Artikel-Nr. article-no.	Farbe colour		VE unit
1407 S	silber/silver		10
1407 SD	sand/sand		10
1407 G	gold/gold		10
1407 B	bronze/bronze		10
1407 EO	titan/EO		10

Preis/Stange price/piece	
270 cm	270 cm
Lagerware	Bestellware
17,89	
	*
	*
	*
	*

3D

13514 A
ÜBERGANGSPROFIL, T-Form, biegefähig
 JOINING PROFILE, T-shape, bendable
 14 x 2 mm

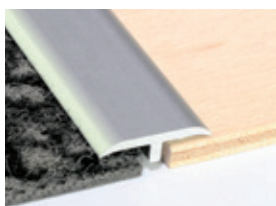

Artikel-Nr. article-no.	Farbe colour		VE unit
13514 A S	silber/silver		10
13514 A SD	sand/sand		10
13514 A G	gold/gold		10
13514 A B	bronze/bronze		10
13514 A EO	titan/EO		10

Preis/Stange price/piece	
270 cm	270 cm
Lagerware	Bestellware
10,05	
	*
	*
	*
14,00	

13514
ÜBERGANGSPROFIL, T-Form, biegefähig
 JOINING PROFILE, T-shape, bendable
 14 x 7 mm

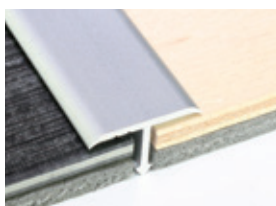

Artikel-Nr. article-no.	Farbe colour		VE unit
13514 S	silber/silver		10
13514 SD	sand/sand		10
13514 G	gold/gold		10
13514 B	bronze/bronze		10
13514 EO	titan/EO		10

Preis/Stange price/piece	
270 cm	270 cm
Lagerware	Bestellware
14,57	
16,87	
16,87	
17,89	
19,75	

13520
ÜBERGANGSPROFIL, T-Form, biegefähig
 JOINING PROFILE, T-shape, bendable
 20 x 7 mm

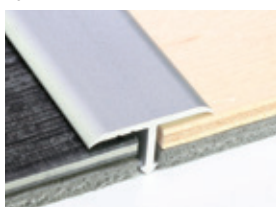

Artikel-Nr. article-no.	Farbe colour		VE unit
13520 S	silber/silver		10
13520 SD	sand/sand		10
13520 G	gold/gold		10
13520 B	bronze/bronze		10
13520 EO	titan/EO		10

Preis/Stange price/piece	
270 cm	270 cm
Lagerware	Bestellware
15,40	
17,79	
17,79	
19,48	
18,12	

13526
ÜBERGANGSPROFIL, T-Form, biegefähig
 JOINING PROFILE, T-shape, bendable
 26 x 7 mm

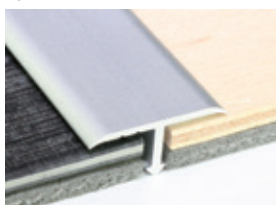

Artikel-Nr. article-no.	Farbe colour		VE unit
13526 S	silber/silver		10
13526 SD	sand/sand		10
13526 G	gold/gold		10
13526 B	bronze/bronze		10
13526 EO	titan/EO		10

Preis/Stange price/piece	
270 cm	270 cm
Lagerware	Bestellware
18,12	
20,42	
20,42	
21,44	
21,44	

* Preis auf Anfrage / price on request

301 A GEB

ÜBERGANGSPROFIL, gebohrt
JOINING PROFILE, drilled
25 mm

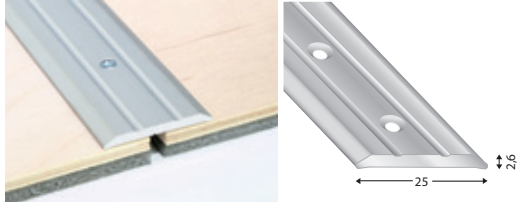

Artikel-Nr. article-no.	Farbe colour	VE unit
301 A S GEB	silber/silver	10
301 A SD GEB	sand/sand	10
301 A G GEB	gold/gold	10

Preis/Stange price/piece		Preis/Stück price/piece	
270 cm	270 cm	100 cm	100 cm
Lagerware	Bestellware	Lagerware	Bestellware
15,86			
16,87			
16,87			

301 A UNG

ÜBERGANGSPROFIL, ungebohrt
JOINING PROFILE, undrilled
25 mm

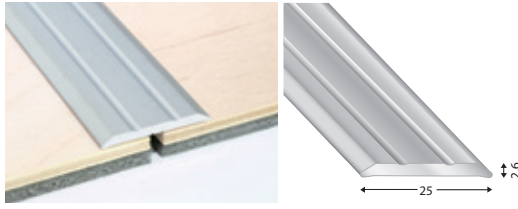

Artikel-Nr. article-no.	Farbe colour	VE unit
301 A S	silber/silver	10
301 A SD	sand/sand	10
301 A G	gold/gold	10
301 A B	bronze/bronze	10
301 A EO	titan/EO	10

Preis/Stange price/piece		Preis/Stück price/piece	
270 cm	270 cm	100 cm	100 cm
Lagerware	Bestellware	Lagerware	Bestellware
14,17			
16,70			
16,70			
17,95			
17,03			

301 A SKL

ÜBERGANGSPROFIL, selbstklebend
JOINING PROFILE, self-adhesive
25 mm

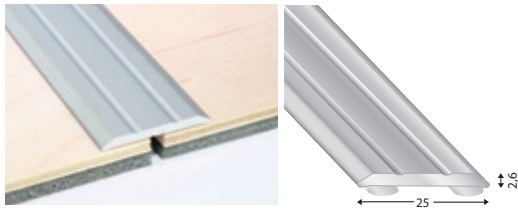

Artikel-Nr. article-no.	Farbe colour	VE unit
301 A S SKL	silber/silver	10
301 A S 100	silber/silver	10
301 A SD SKL	sand/sand	10
301 A SD 100	sand/sand	10
301 A G SKL	gold/gold	10
301 A G 100	gold/gold	10
301 A B SKL	bronze/bronze	10
301 A B 100	bronze/bronze	10
301 A EO SKL	titan/EO	10
301 A EO 100	titan/EO	10

Preis/Stange price/piece		Preis/Stück price/piece	
270 cm	270 cm	100 cm	100 cm
Lagerware	Bestellware	Lagerware	Bestellware
16,93			
		7,59	
19,52		7,98	
19,52		7,98	
20,77		9,05	
19,98		9,05	

301

ÜBERGANGSPROFIL, gebohrt
JOINING PROFILE, drilled
30 mm

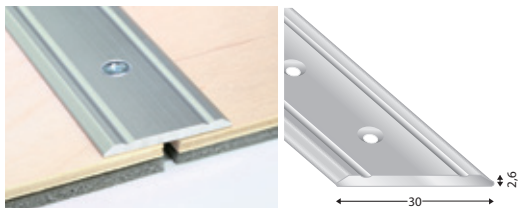

Artikel-Nr. article-no.	Farbe colour	VE unit
301 S	silber/silver	10
301 S 100	silber/silver	10
301 SD	sand/sand	10
301 SD 100	sand/sand	10
301 G	gold/gold	10
301 G 100	gold/gold	10
301 B	bronze/bronze	10
301 B 100	bronze/bronze	10
301 EO	titan/EO	10
301 EO 100	titan/EO	10

Preis/Stange price/piece		Preis/Stück price/piece	
270 cm	270 cm	100 cm	100 cm
Lagerware	Bestellware	Lagerware	Bestellware
16,59			
		7,44	
19,19		8,38	
19,19		8,38	
20,38		8,84	
19,52		8,84	

301 X

ÜBERGANGSPROFIL, gebohrt, verpackt mit Schrauben
JOINING PROFILE, drilled, packed with screws
30 mm

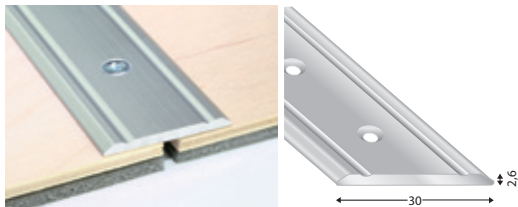

Artikel-Nr. article-no.	Farbe colour	VE unit
301 S X	silber/silver	10
301 SD X	sand/sand	10

Preis/Stange price/piece		Preis/Stück price/piece	
270 cm	270 cm	100 cm	100 cm
Lagerware	Bestellware	Lagerware	Bestellware
19,73			
22,32			

NEU! 270 cm Stangen verpackt mit Schrauben
NEW! 270 cm profiles packed with screws



638
ÜBERGANGSPROFIL, gebohrt
 JOINING PROFILE, drilled
 38 mm

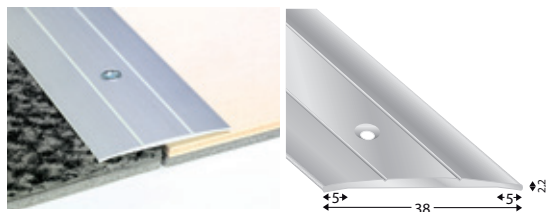

Artikel-Nr. article-no.	Farbe colour	VE unit
638 S GEB	silber/silver	10
638 S 100		10
638 SD GEB	sand/sand	10
638 SD 100		10
638 G GEB	gold/gold	10
638 G 100		10
638 B GEB	bronzel/bronze	10
638 B 100		10
638 EO GEB	titan/titan	10
638 EO 100		10

Preis/Stange price/price		Preis/Stück price/price	
270 cm	270 cm	100 cm	100 cm
Lagerware	Bestellware	Lagerware	Bestellware
16,59		7,29	
17,39		7,54	
17,39		7,54	
16,87		7,36	
16,87		7,36	

638 UNG
ÜBERGANGSPROFIL, ungebohrt
 JOINING PROFILE, undrilled
 38 mm

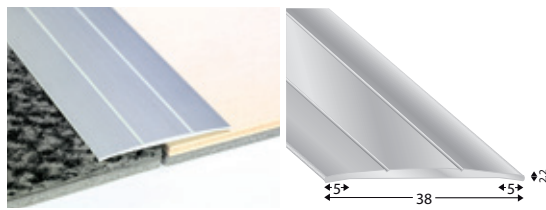

Artikel-Nr. article-no.	Farbe colour	VE unit
638 S UNG	silber/silver	10
638 SD UNG	sand/sand	10
638 G UNG	gold/gold	10
638 B UNG	bronzel/bronze	10
638 EO UNG	titan/titan	10

Preis/Stange price/price		Preis/Stück price/price	
270 cm	270 cm	100 cm	100 cm
Lagerware	Bestellware	Lagerware	Bestellware
14,57			
15,70			
15,70			
14,78			
14,78			

638 SKL
ÜBERGANGSPROFIL, selbstklebend
 JOINING PROFILE, self-adhesive
 38 mm

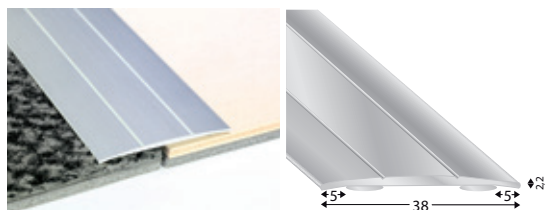

Artikel-Nr. article-no.	Farbe colour	VE unit
638 S SKL	silber/silver	10
638 S 100 S		10
638 SD SKL	sand/sand	10
638 SD 100 S		10
638 G SKL	gold/gold	10
638 G 100 S		10
638 B SKL	bronzel/bronze	10
638 B 100 S		10
638 EO SKL	titan/titan	10
638 EO 100 S		10
638 SW SKL	eloxiert 9005	10
638 SW 100 S		10

Preis/Stange price/price		Preis/Stück price/price	
270 cm	270 cm	100 cm	100 cm
Lagerware	Bestellware	Lagerware	Bestellware
19,12		7,98	
20,31		8,30	
20,31		8,30	
19,42		8,03	
19,42		8,03	
	*	8,03	*

303
ÜBERGANGSPROFIL, gebohrt
 JOINING PROFILE, drilled
 31,7 mm

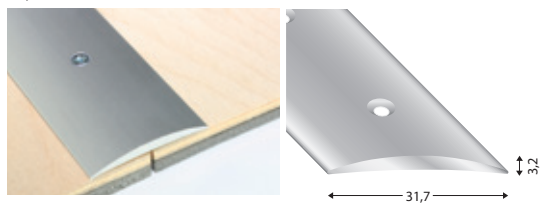

Artikel-Nr. article-no.	Farbe colour	VE unit
303 S	silber/silver	10

Preis/Stange price/price		Preis/Stück price/price	
270 cm	270 cm	100 cm	100 cm
Lagerware	Bestellware	Lagerware	Bestellware
16,47			

304 GEB
ÜBERGANGSPROFIL, gebohrt
 JOINING PROFILE, drilled
 38 mm

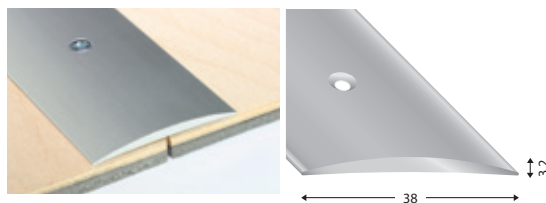

Artikel-Nr. article-no.	Farbe colour	VE unit
304 S GEB	silber/silver	10

Preis/Stange price/price		Preis/Stück price/price	
270 cm	270 cm	100 cm	100 cm
Lagerware	Bestellware	Lagerware	Bestellware
20,38			

304 UNG
ÜBERGANGSPROFIL, ungebohrt
 JOINING PROFILE, undrilled
 38 mm

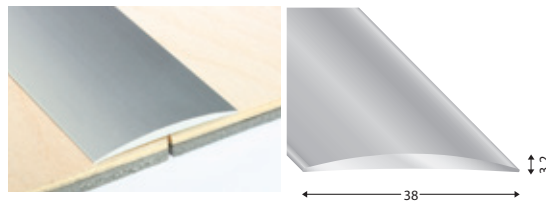

Artikel-Nr. article-no.	Farbe colour	VE unit
304 S	silber/silver	10

Preis/Stange price/price		Preis/Stück price/price	
270 cm	270 cm	100 cm	100 cm
Lagerware	Bestellware	Lagerware	Bestellware
18,85			

* Preis auf Anfrage / price on request

503 20
ÜBERGANGSPROFIL, selbstklebend
JOINING PROFILE, self-adhesive
 20 mm



Artikel-Nr. article-no.	Farbe colour	VE unit
503 20 S	silber/silver	10
503 20 S 100		10
503 20 SD	sand/sand	10
503 20 SD100		10
503 20 G	gold/gold	10
503 20 G 100		10
503 20 B	bronze/bronze	10
503 20 B 100		10
503 20 EO	titan/titan	10
503 20 EO100		10

Preis/Stange price/price		Preis/Stück price/price	
270 cm	270 cm	100 cm	100 cm
Lagerware	Bestellware	Lagerware	Bestellware
21,02		8,60	
	*		*
	*		*
	*		*
	*		*

803 30
ÜBERGANGSPROFIL, gebohrt
JOINING PROFILE, drilled
 30 mm



Artikel-Nr. article-no.	Farbe colour	VE unit
803 30 S	silber/silver	10
803 30 S 100		10
803 30 SD	sand/sand	10
803 30 SD100		10
803 30 G	gold/gold	10
803 30 G 100		10
803 30 B	bronze/bronze	10
803 30 B 100		10
803 30 EO	titan/titan	10
803 30 EO100		10

Preis/Stange price/price		Preis/Stück price/price	
270 cm	270 cm	100 cm	100 cm
Lagerware	Bestellware	Lagerware	Bestellware
20,82		9,07	
		9,80	
		9,80	
		11,52	
		11,39	

803 30 UNG
ÜBERGANGSPROFIL, ungebohrt
JOINING PROFILE, undrilled
 30 mm



Artikel-Nr. article-no.	Farbe colour	VE unit
803 30 S UNG	silber/silver	10
803 30 SD UN	sand/sand	10
803 30 G UNG	gold/gold	10
803 30 B UNG	bronze/bronze	10
803 30 EO UN	titan/titan	10

Preis/Stange price/price		Preis/Stück price/price	
270 cm	270 cm	100 cm	100 cm
Lagerware	Bestellware	Lagerware	Bestellware
20,82			

503 30
ÜBERGANGSPROFIL, selbstklebend
JOINING PROFILE, self-adhesive
 30 mm

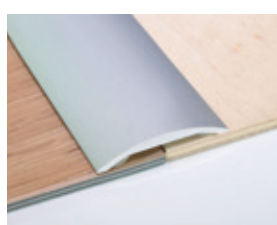

Artikel-Nr. article-no.	Farbe colour	VE unit
503 30 S	silber/silver	10
503 30 S 100		10
503 30 SD	sand/sand	10
503 30 SD100		10
503 30 G	gold/gold	10
503 30 G 100		10
503 30 B	bronze/bronze	10
503 30 B 100		10
503 30 EO	titan/titan	10
503 30 EO100		10

Preis/Stange price/price		Preis/Stück price/price	
270 cm	270 cm	100 cm	100 cm
Lagerware	Bestellware	Lagerware	Bestellware
25,50		10,47	
		11,39	
		11,39	
		13,19	
		13,19	

* Preis auf Anfrage / price on request



803 40
ÜBERGANGSPROFIL, gebohrt
 JOINING PROFILE, drilled
 40 mm

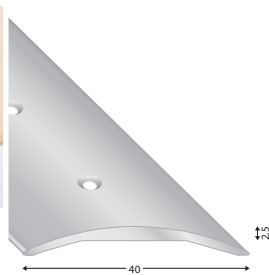

Artikel-Nr. article-no.	Farbe colour	VE unit
803 40 S	silber/silver	10
803 40 S 100		10
803 40 SD	sand/sand	10
803 40 SD100		10
803 40 G	gold/gold	10
803 40 G 100		10
803 40 B	bronze/bronze	10
803 40 B 100		10
803 40 EO	titan/EO	10
803 40 EO100		10

Preis/Stange price/piece	
270 cm	270 cm
Lagerware	Bestellware
24,60	
26,81	
26,81	
31,89	
27,32	

Preis/Stück price/piece	
100 cm	100 cm
Lagerware	Bestellware
10,45	
11,29	
11,29	
13,17	
11,54	

803 40 UNG
ÜBERGANGSPROFIL, ungebohrt
 JOINING PROFILE, undrilled
 40 mm

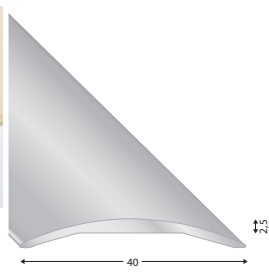
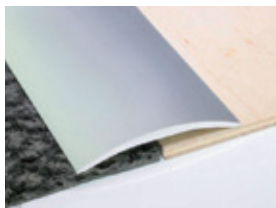

Artikel-Nr. article-no.	Farbe colour	VE unit
803 40 S UNG	silber/silver	10
803 40 SD UN	sand/sand	10
803 40 G UNG	gold/gold	10
803 40 B UNG	bronze/bronze	10
803 40 EO UN	titan/EO	10

Preis/Stange price/piece	
270 cm	270 cm
Lagerware	Bestellware
24,60	
26,81	
26,81	
31,89	
27,38	

Preis/Stück price/piece	
100 cm	100 cm
Lagerware	Bestellware

503 40
ÜBERGANGSPROFIL, selbstklebend
 JOINING PROFILE, self-adhesive
 40 mm



Artikel-Nr. article-no.	Farbe colour	VE unit
503 40 S	silber/silver	10
503 40 S 100		10
503 40 SD	sand/sand	10
503 40 SD100		10
503 40 G	gold/gold	10
503 40 G 100		10
503 40 B	bronze/bronze	10
503 40 B 100		10
503 40 EO	titan/EO	10
503 40 EO100		10

Preis/Stange price/piece	
270 cm	270 cm
Lagerware	Bestellware
29,28	
31,37	
31,37	
36,51	
32,10	

Preis/Stück price/piece	
100 cm	100 cm
Lagerware	Bestellware
12,04	
12,90	
12,90	
15,03	
13,19	

803 50
ÜBERGANGSPROFIL, gebohrt
 JOINING PROFILE, drilled
 50 mm

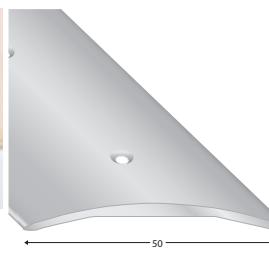

Artikel-Nr. article-no.	Farbe colour	VE unit
803 50 S	silber/silver	10
803 50 S 100		10
803 50 SD	sand/sand	10
803 50 SD100		10
803 50 G	gold/gold	10
803 50 G 100		10
803 50 B	bronze/bronze	10
803 50 B 100		10

Preis/Stange price/piece	
270 cm	270 cm
Lagerware	Bestellware
28,22	
30,41	
30,41	
36,45	

Preis/Stück price/piece	
100 cm	100 cm
Lagerware	Bestellware
11,77	
12,62	
12,62	
14,86	

803 50 UNG
ÜBERGANGSPROFIL, ungebohrt
 JOINING PROFILE, undrilled
 50 mm

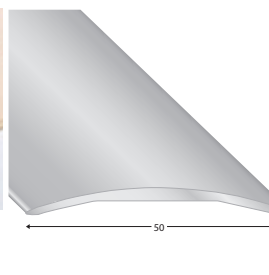
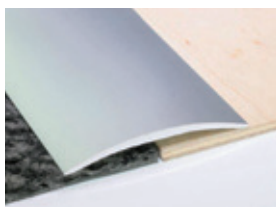

Artikel-Nr. article-no.	Farbe colour	VE unit
803 50 S UNG	silber/silver	10
803 50 SD UN	sand/sand	10
803 50 G UNG	gold/gold	10
803 50 B UNG	bronze/bronze	10

Preis/Stange price/piece	
270 cm	270 cm
Lagerware	Bestellware
28,22	
30,41	
30,41	
36,45	

Preis/Stück price/piece	
100 cm	100 cm
Lagerware	Bestellware

503 50
ÜBERGANGSPROFIL, selbstklebend
 JOINING PROFILE, self-adhesive
 50 mm

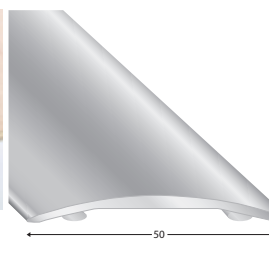

Artikel-Nr. article-no.	Farbe colour	VE unit
503 50 S	silber/silver	10
503 50 S 100		10
503 50 SD	sand/sand	10
503 50 SD100		10
503 50 G	gold/gold	10
503 50 G 100		10
503 50 B	bronze/bronze	10
503 50 B 100		10

Preis/Stange price/piece	
270 cm	270 cm
Lagerware	Bestellware
32,83	
35,05	
35,05	
41,19	

Preis/Stück price/piece	
100 cm	100 cm
Lagerware	Bestellware
13,50	
14,40	
14,40	
16,95	

136 CP 8 UNG

ÜBERGANGSPROFIL, ungebohrt
JOINING PROFILE, undrilled
80 mm

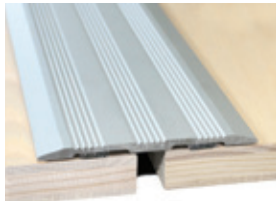

Artikel-Nr. article-no.	Farbe colour	VE unit
136 CP 8 U S	silber/silver	10

Preis/Stange price/piece	
270 cm	270 cm
Lagerware	Bestellware
86,00	

136 CP 8

ÜBERGANGSPROFIL, selbstklebend
JOINING PROFILE, self-adhesive
80 mm

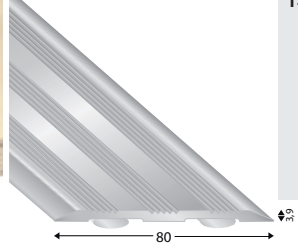

Artikel-Nr. article-no.	Farbe colour	VE unit
136 CP 8 S	silber/silver	10

Preis/Stange price/piece	
270 cm	270 cm
Lagerware	Bestellware
98,25	

108 F

ÜBERGANGSPROFIL, gebohrt
JOINING PROFILE, drilled
Innenhöhe / inner height 3 mm

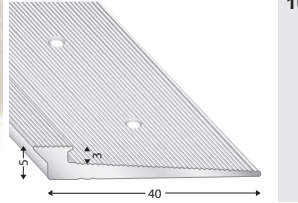
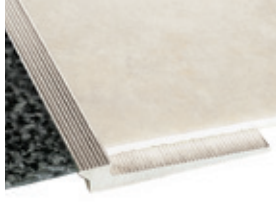

Artikel-Nr. article-no.	Farbe colour	VE unit
108 F S	silber/silver	10

Preis/Stange price/piece	
270 cm	270 cm
Lagerware	Bestellware
26,63	

108 G

ÜBERGANGSPROFIL, gebohrt
JOINING PROFILE, drilled
Innenhöhe / inner height 4 mm

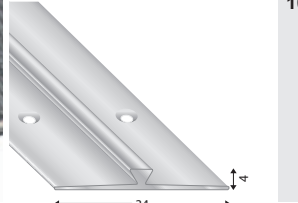
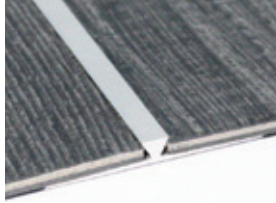

Artikel-Nr. article-no.	Farbe colour	VE unit
108 G S	silber/silver	10

Preis/Stange price/piece	
270 cm	270 cm
Lagerware	Bestellware
14,00	

108 I

ÜBERGANGSPROFIL, gebohrt
JOINING PROFILE, drilled
Innenhöhe / inner height 2,5 mm

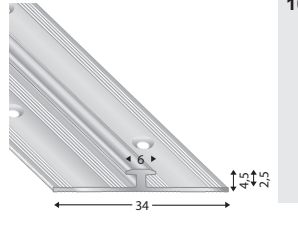

Artikel-Nr. article-no.	Farbe colour	VE unit
108 I S	silber/silver	10

Preis/Stange price/piece	
270 cm	270 cm
Lagerware	Bestellware
21,61	

108 J

ÜBERGANGSPROFIL, gebohrt
JOINING PROFILE, drilled
Innenhöhe / inner height 4,5 mm

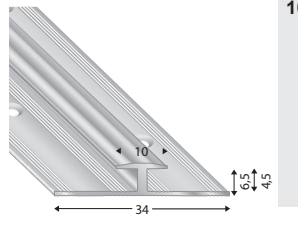

Artikel-Nr. article-no.	Farbe colour	VE unit
108 J S	silber/silver	10

Preis/Stange price/piece	
270 cm	270 cm
Lagerware	Bestellware
22,74	

3D

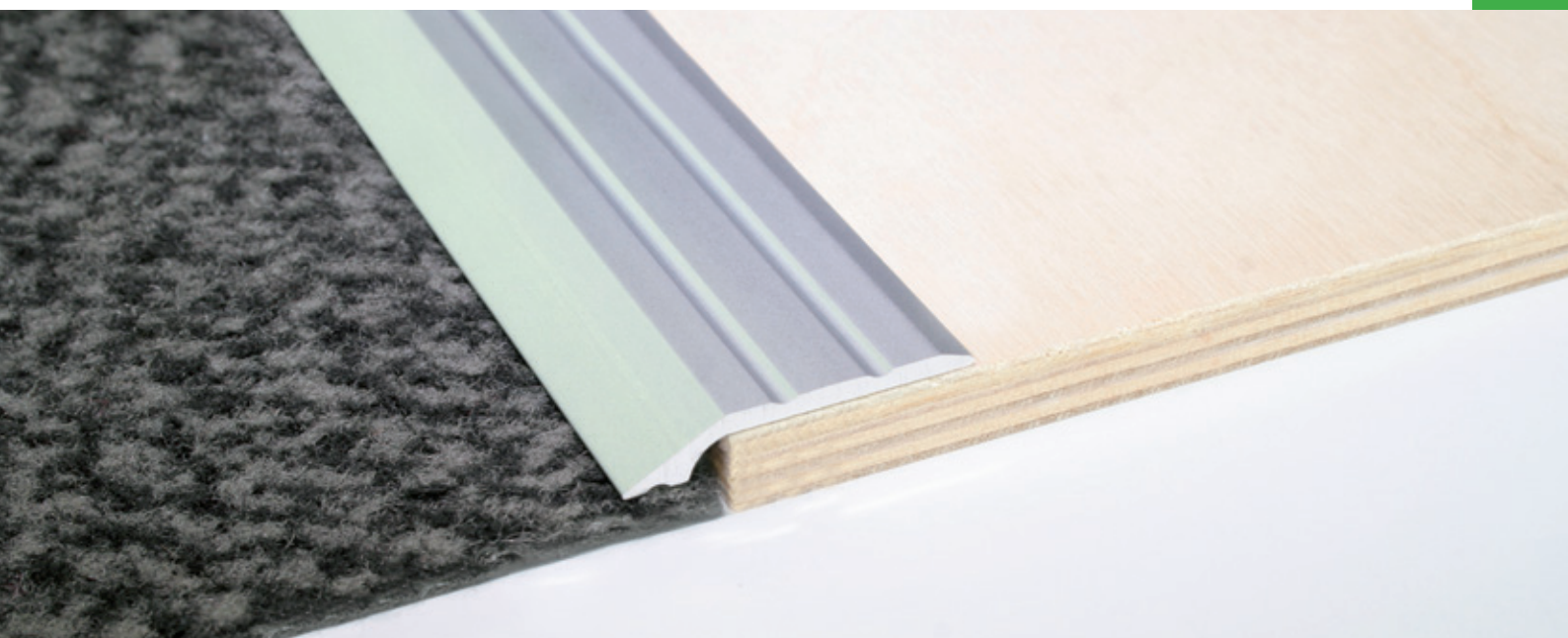

AUSGLEICHSPROFILE

aus Aluminium

LEVEL ADAPTING PROFILES

in aluminium

201
AUSGLEICHSPROFIL, gebohrt
 LEVEL ADAPTING PROFILE, drilled
 Höhen bis / heights up to 3,5 mm

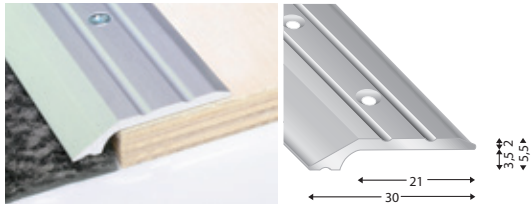

Artikel-Nr. article-no.	Farbe colour	VE unit
201 S	silber/silver	10
201 S 100		10
201 SD	sand/sand	10
201 SD 100		10
201 G	gold/gold	10
201 G 100		10
201 B	bronze/bronze	10
201 B 100		10
201 EO	titan/EO	10
201 EO 100		10

Preis/Stange price/piece		Preis/Stück price/piece	
270 cm	270 cm	100 cm	100 cm
Lagerware	Bestellware	Lagerware	Bestellware
14,34		6,58	
17,26		7,67	
17,26		7,67	
18,45		8,15	
17,66		8,15	

201 X
AUSGLEICHSPROFIL, gebohrt, verpackt mit Schrauben
 LEVEL ADAPTING PROFILE, drilled, packed with screws
 Höhen bis / heights up to 3,5 mm

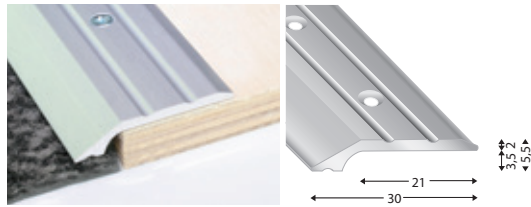

NEU! 270 cm Stangen verpackt mit Schrauben
NEW! 270 cm profiles packed with screws

Artikel-Nr. article-no.	Farbe colour	VE unit
201 S X	silber/silver	10
201 SD X	sand/sand	10

Preis/Stange price/piece		Preis/Stück price/piece	
270 cm	270 cm	100 cm	100 cm
Lagerware	Bestellware	Lagerware	Bestellware
17,47			
20,40			

201 UNGB
AUSGLEICHSPROFIL, ungebohrt
 LEVEL ADAPTING PROFILE, undrilled
 Höhen bis / heights up to 3,5 mm

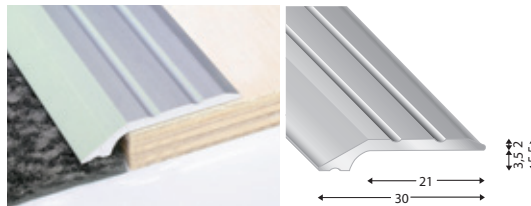

Artikel-Nr. article-no.	Farbe colour	VE unit
201 S UNGB	silber/silver	10
201 SD UNG	sand/sand	10
201 G UNGB	gold/gold	10
201 B UNGB	bronze/bronze	10
201 EO UNGB	titan/EO	10

Preis/Stange price/piece		Preis/Stück price/piece	
270 cm	270 cm	100 cm	100 cm
Lagerware	Bestellware	Lagerware	Bestellware
14,34			
17,26			
17,26			
18,45			
17,66			

201 SKL
AUSGLEICHSPROFIL, selbstklebend
 LEVEL ADAPTING PROFILE, self-adhesive
 Höhen bis / heights up to 3,5 mm

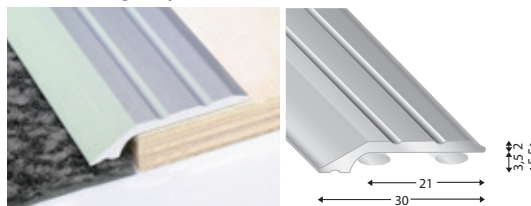

Artikel-Nr. article-no.	Farbe colour	VE unit
201 S SKL	silber/silver	10
201 S 100 S		10
201 SD SKL	sand/sand	10
201 SD 100 S		10
201 G SKL	gold/gold	10
201 G 100 S		10
201 B SKL	bronze/bronze	10
201 B 100 S		10
201 EO SKL	titan/EO	10
201 EO 100 S		10

Preis/Stange price/piece		Preis/Stück price/piece	
270 cm	270 cm	100 cm	100 cm
Lagerware	Bestellware	Lagerware	Bestellware
17,16		7,69	
20,21		8,82	
20,21		8,82	
21,38		9,26	
20,54		9,01	

* Preis auf Anfrage / price on request

2202
AUSGLEICHSPROFIL, gebohrt
 LEVEL ADAPTING PROFILE, drilled
 Höhen bis / heights up to 5,5 mm

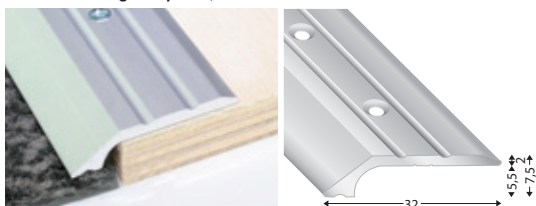

Artikel-Nr. article-no.	Farbe colour	VE unit
2202 S	silber/silver	10
2202 S 100		10
2202 SD	sand/sand	10
2202 SD 100		10
2202 G	gold/gold	10
2202 G 100		10
2202 B	bronze/bronze	10
2202 B 100		10
2202 EO	titan/EO	10
2202 EO 100		10

Preis/Stange price/piece		Preis/Stück price/piece	
270 cm	270 cm	100 cm	100 cm
Lagerware	Bestellware	Lagerware	Bestellware
19,75		8,67	
	*		*
	*		*
	*		*
	*		*
	*		*

2202 UNGB
AUSGLEICHSPROFIL, ungebohrt
 LEVEL ADAPTING PROFILE, undrilled
 Höhen bis / heights up to 5,5 mm



Artikel-Nr. article-no.	Farbe colour	VE unit
2202 S UNGB	silber/silver	10
2202 SD UNGB	sand/sand	10
2202 G UNGB	gold/gold	10
2202 B UNGB	bronze/bronze	10
2202 EO UNGB	titan/EO	10

Preis/Stange price/piece		Preis/Stück price/piece	
270 cm	270 cm	100 cm	100 cm
Lagerware	Bestellware	Lagerware	Bestellware
19,75			
	*		
	*		
	*		
	*		

2202 SKL
AUSGLEICHSPROFIL, selbstklebend
 LEVEL ADAPTING PROFILE, self-adhesive
 Höhen bis / heights up to 5,5 mm

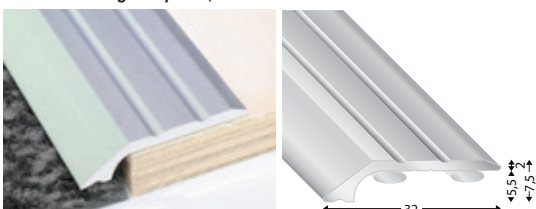

Artikel-Nr. article-no.	Farbe colour	VE unit
2202 S SKL	silber/silver	10
2202 S 100 S		10
2202 SD SKL	sand/sand	10
2202 SD 100S		10
2202 G SKL	gold/gold	10
2202 G 100 S		10
2202 B SKL	bronze/bronze	10
2202 B 100 S		10
2202 EO SKL	titan/EO	10
2202 EO 100S		10

Preis/Stange price/piece		Preis/Stück price/piece	
270 cm	270 cm	100 cm	100 cm
Lagerware	Bestellware	Lagerware	Bestellware
22,91		9,43	
	*		*
	*		*
	*		*
	*		*

* Preis auf Anfrage / price on request

202

AUSGLEICHSPROFIL, gebohrt
 LEVEL ADAPTING PROFILE, drilled
 Höhen bis / heights up to 8 mm



Artikel-Nr. article-no.	Farbe colour	VE unit
202 S	silber/silver	10
202 S 100		10
202 SD	sand/sand	10
202 SD 100		10
202 G	gold/gold	10
202 G 100		10
202 B	bronze/bronze	10
202 B 100		10
202 EO	titan/EO	10
202 EO 100		10

Preis/Stange price/piece		Preis/Stück price/piece	
270 cm	270 cm	100 cm	100 cm
Lagerware	Bestellware	Lagerware	Bestellware
23,70		10,18	
26,42		11,12	
	*		*
	*		*
	*		*
	*		*

202 UNGB

AUSGLEICHSPROFIL, ungebohrt
 LEVEL ADAPTING PROFILE, undrilled
 Höhen bis / heights up to 8 mm

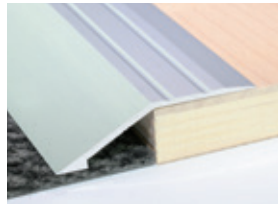

Artikel-Nr. article-no.	Farbe colour	VE unit
202 S UNGB	silber/silver	10
202 SD UNGB	sand/sand	10
202 G UNGB	gold/gold	10
202 B UNGB	bronze/bronze	10
202 EO UNGB	titan/EO	10

Preis/Stange price/piece		Preis/Stück price/piece	
270 cm	270 cm	100 cm	100 cm
Lagerware	Bestellware	Lagerware	Bestellware
23,70			
	*		
	*		
	*		
	*		

202 SKL

AUSGLEICHSPROFIL, selbstklebend
 LEVEL ADAPTING PROFILE, self-adhesive
 Höhen bis / heights up to 8 mm

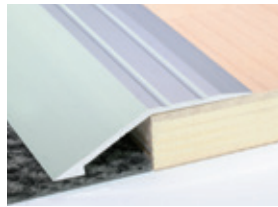

Artikel-Nr. article-no.	Farbe colour	VE unit
202 S SKL	silber/silver	10
202 S 100 S		10
202 SD SKL	sand/sand	10
202 SD 100 S		10
202 G SKL	gold/gold	10
202 G 100 S		10
202 B SKL	bronze/bronze	10
202 B 100 S		10
202 EO SKL	titan/EO	10
202 EO 100 S		10

Preis/Stange price/piece		Preis/Stück price/piece	
270 cm	270 cm	100 cm	100 cm
Lagerware	Bestellware	Lagerware	Bestellware
28,05		12,12	
	*		*
	*		*
	*		*
	*		*

201 10

AUSGLEICHSPROFIL, gebohrt
 LEVEL ADAPTING PROFILE, drilled
 Höhen bis / heights up to 10 mm

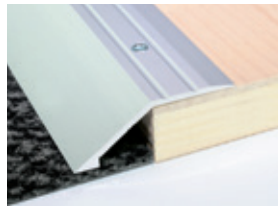

Artikel-Nr. article-no.	Farbe colour	VE unit
201 10 S	silber/silver	10
201 10 S 100		10
201 10 SD	sand/sand	10
201 10 SD100		10
201 10 G	gold/gold	10
201 10 G 100		10
201 10 B	bronze/bronze	10
201 10 B 100		10
201 10 EO	titan/EO	10
201 10 EO100		10

Preis/Stange price/piece		Preis/Stück price/piece	
270 cm	270 cm	100 cm	100 cm
Lagerware	Bestellware	Lagerware	Bestellware
20,61		9,05	
24,37		10,35	
	*		*
	*		*
	*		*
	*		*

201 10 UNGB

AUSGLEICHSPROFIL, ungebohrt
 LEVEL ADAPTING PROFILE, undrilled
 Höhen bis / heights up to 10 mm



Artikel-Nr. article-no.	Farbe colour	VE unit
201 10 S S U	silber/silver	10
201 10 SD S U	sand/sand	10
201 10 G S U	gold/gold	10
201 10 B S U	bronze/bronze	10
201 10 EO S U	titan/EO	10

Preis/Stange price/piece		Preis/Stück price/piece	
270 cm	270 cm	100 cm	100 cm
Lagerware	Bestellware	Lagerware	Bestellware
20,61			
	*		
	*		
	*		
	*		

201 10 SKL

AUSGLEICHSPROFIL, selbstklebend
 LEVEL ADAPTING PROFILE, self-adhesive
 Höhen bis / heights up to 10 mm



Artikel-Nr. article-no.	Farbe colour	VE unit
201 10 S SKL	silber/silver	10
201 10 S 10S		10
201 10 SD SK	sand/sand	10
201 10 SD10S		10
201 10 G SKL	gold/gold	10
201 10 G 10S		10
201 10 B SKL	bronze/bronze	10
201 10 B 10S		10
201 10 EO SK	titan/EO	10
201 10 EO10S		10

Preis/Stange price/piece		Preis/Stück price/piece	
270 cm	270 cm	100 cm	100 cm
Lagerware	Bestellware	Lagerware	Bestellware
24,10		10,26	
	*		*
	*		*
	*		*
	*		*

* Preis auf Anfrage / price on request

201 15
AUSGLEICHSPROFIL, gebohrt
 LEVEL ADAPTING PROFILE, drilled
 Höhen bis / heights up to 15 mm



Artikel-Nr. article-no.	Farbe colour	VE unit
201 15 S	silber/silver	10
201 15 S 100		10
201 15 SD	sand/sand	10
201 15 SD100		10
201 15 G	gold/gold	10
201 15 G 100		10
201 15 B	bronze/bronze	10
201 15 B 100		10
201 15 EO	titan/EO	10
201 15 EO100		10

Preis/Stange price/piece		Preis/Stück price/piece	
270 cm	270 cm	100 cm	100 cm
Lagerware	Bestellware	Lagerware	Bestellware
20,98		9,36	
25,00	*	10,60	*
	*		*
	*		*
	*		*

201 15 UNGB
AUSGLEICHSPROFIL, ungebohrt
 LEVEL ADAPTING PROFILE, undrilled
 Höhen bis / heights up to 15 mm



Artikel-Nr. article-no.	Farbe colour	VE unit
201 15 S S U	silber/silver	10
201 15 SD SU	sand/sand	10
201 15 G S U	gold/gold	10
201 15 B S U	bronze/bronze	10
201 15 EO SU	titan/EO	10

Preis/Stange price/piece		Preis/Stück price/piece	
270 cm	270 cm	100 cm	100 cm
Lagerware	Bestellware	Lagerware	Bestellware
20,98			
	*		
	*		
	*		
	*		

201 15 SKL
AUSGLEICHSPROFIL, selbstklebend
 LEVEL ADAPTING PROFILE, self-adhesive
 Höhen bis / heights up to 15 mm



Artikel-Nr. article-no.	Farbe colour	VE unit
201 15 S SKL	silber/silver	10
201 15 S 10S		10
201 15 SD SK	sand/sand	10
201 15 SD10S		10
201 15 G SKL	gold/gold	10
201 15 G 10S		10
201 15 B SKL	bronze/bronze	10
201 15 B 10S		10
201 15 EO SK	titan/EO	10
201 15 EO10S		10

Preis/Stange price/piece		Preis/Stück price/piece	
270 cm	270 cm	100 cm	100 cm
Lagerware	Bestellware	Lagerware	Bestellware
24,49		10,41	
	*		*
	*		*
	*		*
	*		*

201 22
AUSGLEICHSPROFIL, gebohrt
 LEVEL ADAPTING PROFILE, drilled
 Höhen bis / heights up to 22 mm



Artikel-Nr. article-no.	Farbe colour	VE unit
201 22 S	silber/silver	10

Preis/Stange price/piece		Preis/Stück price/piece	
270 cm	270 cm	100 cm	100 cm
Lagerware	Bestellware	Lagerware	Bestellware
28,15			

201 22 UNG
AUSGLEICHSPROFIL, ungebohrt
 LEVEL ADAPTING PROFILE, undrilled
 Höhen bis / heights up to 22 mm



Artikel-Nr. article-no.	Farbe colour	VE unit
201 22 S UNG	silber/silver	10

Preis/Stange price/piece		Preis/Stück price/piece	
270 cm	270 cm	100 cm	100 cm
Lagerware	Bestellware	Lagerware	Bestellware
28,15			

201 22 SKL
AUSGLEICHSPROFIL, selbstklebend
 LEVEL ADAPTING PROFILE, self-adhesive
 Höhen bis / heights up to 22 mm



Artikel-Nr. article-no.	Farbe colour	VE unit
201 22 S SKL	silber/silver	10

Preis/Stange price/piece		Preis/Stück price/piece	
270 cm	270 cm	100 cm	100 cm
Lagerware	Bestellware	Lagerware	Bestellware
33,96			

* Preis auf Anfrage / price on request

801 38

AUSGLEICHSPROFIL, gebohrt
LEVEL ADAPTING PROFILE, drilled
 38 mm

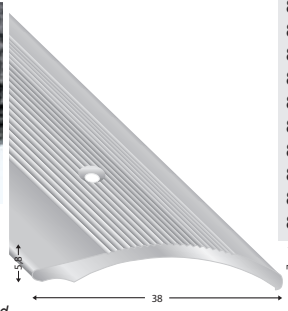

Artikel-Nr. article-no.	Farbe colour	VE unit
801 38 S	silber/silver	10
801 38 S 100		10
801 38 SD	sand/sand	10
801 38 SD100		10
801 38 G	gold/gold	10
801 38 G 100		10
801 38 B	bronze/bronze	10
801 38 B 100		10
801 38 EO	titan/EO	10
801 38 EO100		10

Preis/Stange price/piece	
270 cm	270 cm
Lagerware	Bestellware
30,41	

Preis/Stück price/piece	
100 cm	100 cm
Lagerware	Bestellware
	13,25
	14,34
	14,34
	16,64
	16,64

801 38 UNG

AUSGLEICHSPROFIL, ungebohrt
LEVEL ADAPTING PROFILE, undrilled
 38 mm

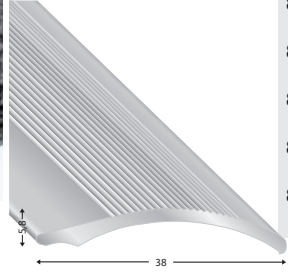

Artikel-Nr. article-no.	Farbe colour	VE unit
801 38 S UNG	silber/silver	10
801 38 SDUNG	sand/sand	10
801 38 G UNG	gold/gold	10
801 38 B UNG	bronze/bronze	10
801 38 EOUNG	titan/EO	10

Preis/Stange price/piece	
270 cm	270 cm
Lagerware	Bestellware
30,41	
33,52	
33,52	
40,00	
40,00	

Preis/Stück price/piece	
100 cm	100 cm
Lagerware	Bestellware

501 38 SKL

AUSGLEICHSPROFIL, selbstklebend
LEVEL ADAPTING PROFILE, self-adhesive
 38 mm



Artikel-Nr. article-no.	Farbe colour	VE unit
501 38 S	silber/silver	10
501 38 S 100		10
501 38 SD	sand/sand	10
501 38 SD100		10
501 38 G	gold/gold	10
501 38 G 100		10
501 38 B	bronze/bronze	10
501 38 B 100		10
501 38 EO	titan/EO	10
501 38 EO100		10
501 38 SW	eloxiert 9005	10
501 38 SW100		10

Preis/Stange price/piece	
270 cm	270 cm
Lagerware	Bestellware
37,24	
40,40	
40,40	
46,84	
46,84	*

Preis/Stück price/piece	
100 cm	100 cm
Lagerware	Bestellware
	15,30
	16,64
	16,64
	19,27
	19,27

1340 3

AUSGLEICHSPROFIL
LEVEL ADAPTING PROFILE
 Höhen bis / heights up to 3 mm

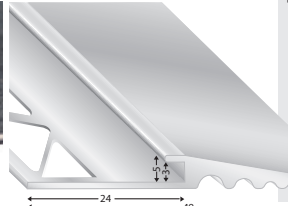

Artikel-Nr. article-no.	Farbe colour	VE unit
1340 3 S 3	silber/silver	10

Preis/Stange price/piece	
300 cm	300 cm
Lagerware	Bestellware
31,91	

Preis/Stück price/piece	
100 cm	100 cm
Lagerware	Bestellware

1340 4

AUSGLEICHSPROFIL
LEVEL ADAPTING PROFILE
 Höhen bis / heights up to 4 mm

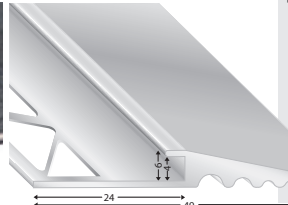
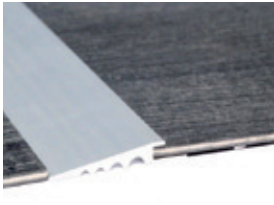

Artikel-Nr. article-no.	Farbe colour	VE unit
1340 4 S 3	silber/silver	10

Preis/Stange price/piece	
300 cm	300 cm
Lagerware	Bestellware
35,49	

Preis/Stück price/piece	
100 cm	100 cm
Lagerware	Bestellware

1340 5,5

AUSGLEICHSPROFIL
LEVEL ADAPTING PROFILE
 Höhen bis / heights up to 5,5 mm

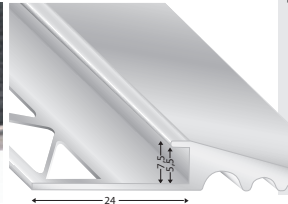
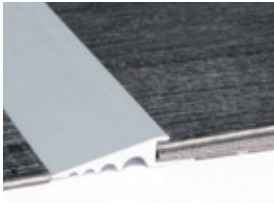

Artikel-Nr. article-no.	Farbe colour	VE unit
1340 5,5 S 3	silber/silver	10

Preis/Stange price/piece	
300 cm	300 cm
Lagerware	Bestellware
38,12	

Preis/Stück price/piece	
100 cm	100 cm
Lagerware	Bestellware

* Preis auf Anfrage / price on request

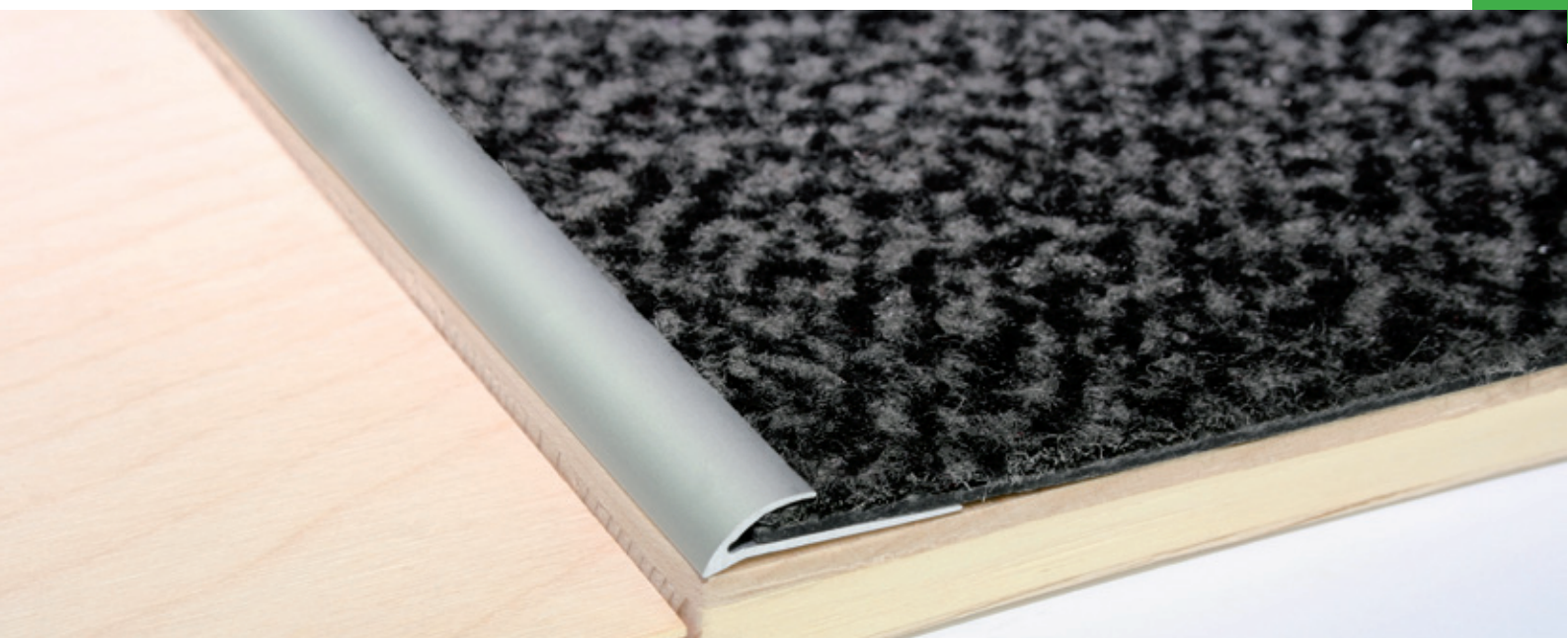

KLEMMPROFILE

aus Aluminium

EDGE TRIM PROFILES

in aluminium

206 A
KLEMM-ABSCHLUSSPROFIL, ungebohrt
EDGE TRIM END PROFILE, undrilled
 Höhen bis / heights up to 4 mm

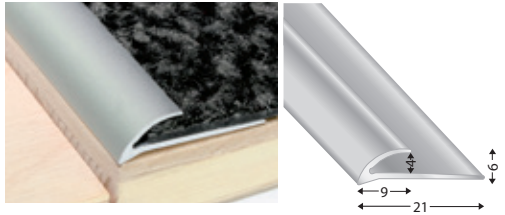

Artikel-Nr. article-no.	Farbe colour	VE unit
206 A S	silber/silver	10
206 A G	gold/gold	10
206 A B	bronze/bronze	10
206 A EO	titan/EO	10

Preis/Stange price/piece		Preis/Stück price/piece	
270 cm	270 cm	100 cm	100 cm
Lagerware	Bestellware	Lagerware	Bestellware
11,18			
	*		
	*		
	*		

208 A
KLEMM-ABSCHLUSSPROFIL, ungebohrt
EDGE TRIM END PROFILE, undrilled
 Höhen bis / heights up to 8,8 mm

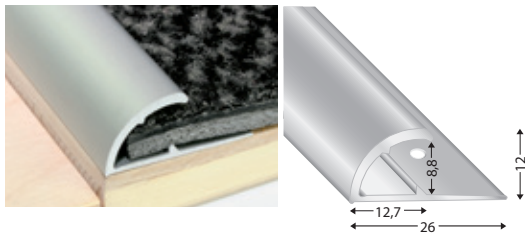

Artikel-Nr. article-no.	Farbe colour	VE unit
208 A S	silber/silver	10
208 A G	gold/gold	10
208 A B	bronze/bronze	10
208 A EO	titan/EO	10

Preis/Stange price/piece		Preis/Stück price/piece	
270 cm	270 cm	100 cm	100 cm
Lagerware	Bestellware	Lagerware	Bestellware
15,86			
	*		
	*		
	*		

306
KLEMM-ABSCHLUSSPROFIL, ungebohrt
EDGE TRIM END PROFILE, undrilled
 Höhen bis / heights up to 7,7 mm

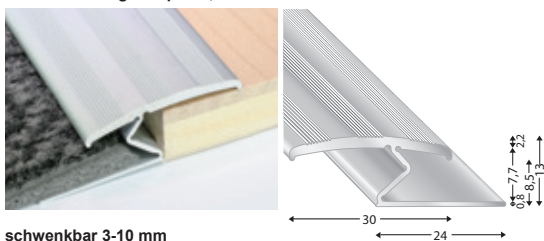

Artikel-Nr. article-no.	Farbe colour	VE unit
306 S	silber/silver	10
306 SD	sand/sand	10
306 G	gold/gold	10
306 B	bronze/bronze	10

Preis/Stange price/piece		Preis/Stück price/piece	
270 cm	270 cm	90 cm	90 cm
Lagerware	Bestellware	Lagerware	Bestellware
20,71			
	*		
	*		
	*		

schwenkbar 3-10 mm
 swiveling 3-10 mm

307
KLEMM-ABSCHLUSSPROFIL, ungebohrt
EDGE TRIM END PROFILE, undrilled
 Höhen bis / heights up to 16 mm

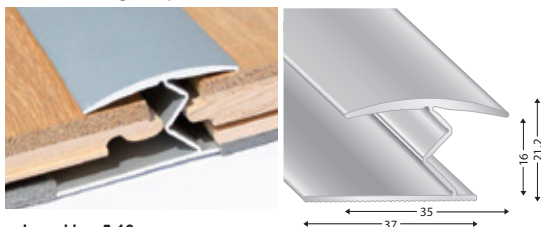

Artikel-Nr. article-no.	Farbe colour	VE unit
307 S	silber/silver	10
307 SD	sand/sand	10
307 G	gold/gold	10
307 B	bronze/bronze	10

Preis/Stange price/piece		Preis/Stück price/piece	
270 cm	270 cm	100 cm	100 cm
Lagerware	Bestellware	Lagerware	Bestellware
27,88			
	*		
	*		
	*		

schwenkbar 5-16 mm
 swiveling 5-16 mm

* Preis auf Anfrage / price on request

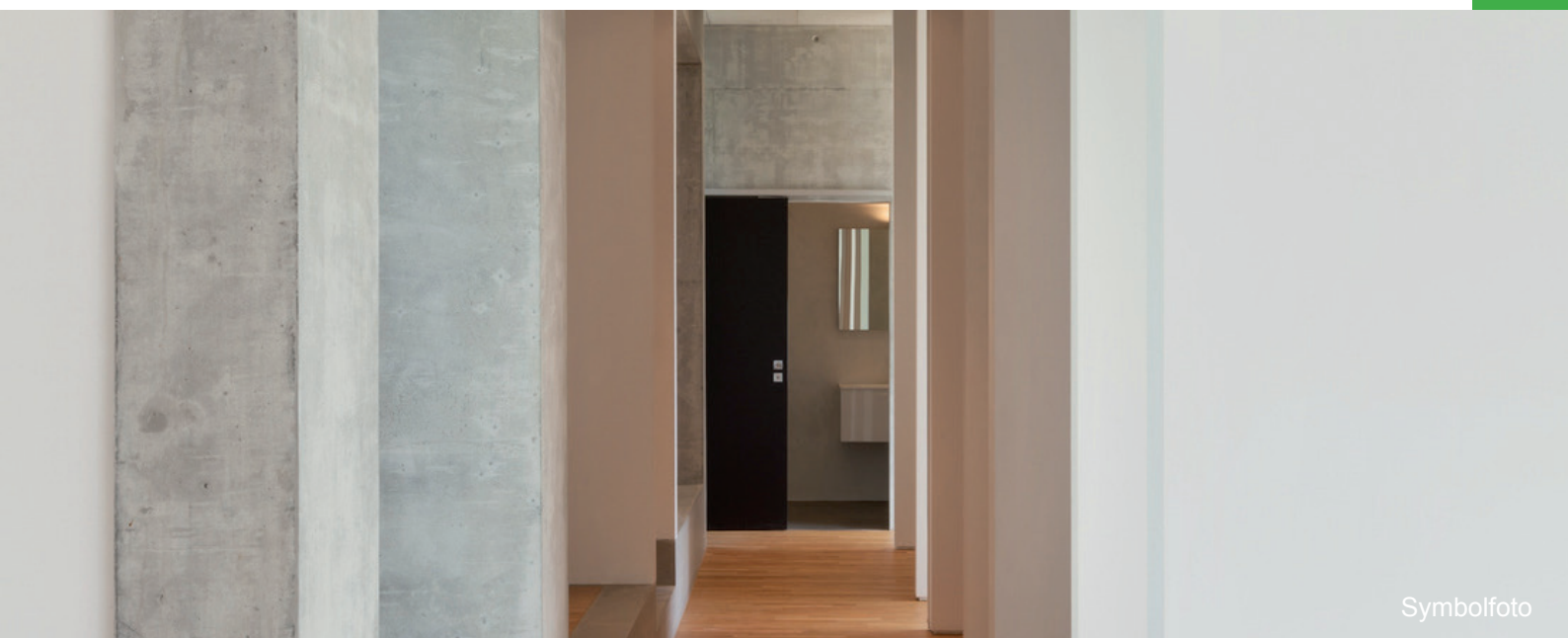

Symbolfoto

MAUERKANTEN

aus Aluminium

WALL CORNERS

in aluminium

123 25

MAUERKANTE, ungebohrt
WALL CORNER, undrilled
25x25x1,5 mm

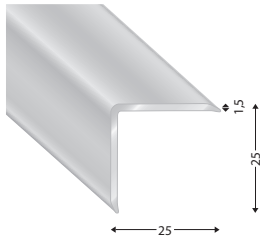

Artikel-Nr. article-no.	Farbe colour	VE unit
123 25 S	silber/silver	10
123 25 S 150		10
123 25 EO	titan/EO	10
123 25 EO150		10

Preis/Stange price/piece		Preis/Stück price/piece	
300 cm	300 cm	150 cm	150 cm
Lagerware	Bestellware	Lagerware	Bestellware
		8,78	
17,12		9,59	

123 40

MAUERKANTE, ungebohrt
WALL CORNER, undrilled
40x40x1,5 mm

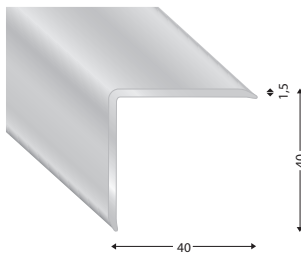

Artikel-Nr. article-no.	Farbe colour	VE unit
123 40 S	silber/silver	10
123 40 S150		10
123 40 EO	titan/EO	10
123 40 EO150		10

Preis/Stange price/piece		Preis/Stück price/piece	
300 cm	300 cm	150 cm	150 cm
Lagerware	Bestellware	Lagerware	Bestellware
		13,10	
25,77		14,27	
28,09			

20102

ESTRICHWINKEL, ungebohrt
SCREED PROFILE, undrilled
20x10x2mm

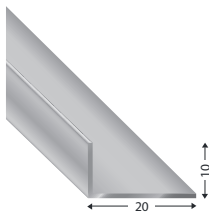

Artikel-Nr. article-no.	Farbe colour	VE unit
20102 S	silber/silver	10
20102 R	roh/raw	10

Preis/Stange price/piece		Preis/Stück price/piece	
300 cm	300 cm	100 cm	100 cm
Lagerware	Bestellware	Lagerware	Bestellware
14,36			
8,40			

20202

ESTRICHWINKEL, ungebohrt
SCREED PROFILE, undrilled
20x20x2mm

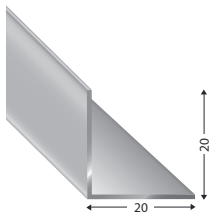

Artikel-Nr. article-no.	Farbe colour	VE unit
20202 S	silber/silver	10
20202 R	roh/raw	10

Preis/Stange price/piece		Preis/Stück price/piece	
300 cm	300 cm	100 cm	100 cm
Lagerware	Bestellware	Lagerware	Bestellware
17,56			
11,72			

25252

ESTRICHWINKEL, ungebohrt
SCREED PROFILE, undrilled
25x25x2 mm

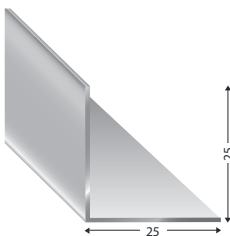

Artikel-Nr. article-no.	Farbe colour	VE unit
25252 S	silber/silver	10
25252 R	roh/raw	10

Preis/Stange price/piece		Preis/Stück price/piece	
300 cm	300 cm	100 cm	100 cm
Lagerware	Bestellware	Lagerware	Bestellware
20,38			
14,48			

30152

ESTRICHWINKEL, ungebohrt
SCREED PROFILE, undrilled
30x15x2 mm

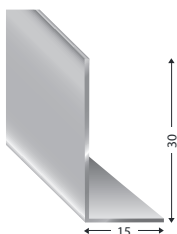

Artikel-Nr. article-no.	Farbe colour	VE unit
30152 S	silber/silver	10
30152 R	roh/raw	10

Preis/Stange price/piece		Preis/Stück price/piece	
300 cm	300 cm	100 cm	100 cm
Lagerware	Bestellware	Lagerware	Bestellware
18,75			
12,85			

3G



30202

ESTRICHWINKEL, ungebohrt
SCREED PROFILE, undrilled
30x20x2mm

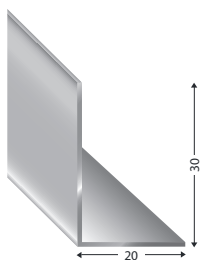

Artikel-Nr. article-no.	Farbe colour	VE unit
30202 S	silber/silver	10
30202 R	roh/raw	10

Preis/Stange price/piece		Preis/Stück price/piece	
300 cm	300 cm	100 cm	100 cm
Lagerware	Bestellware	Lagerware	Bestellware
20,38			
14,48			

30302

ESTRICHWINKEL, ungebohrt
SCREED PROFILE, undrilled
30x30x2mm

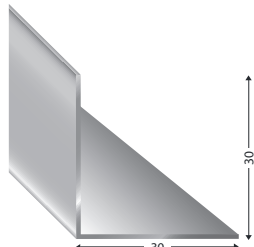

Artikel-Nr. article-no.	Farbe colour	VE unit
30302 S	silber/silver	10
30302 R	roh/raw	10

Preis/Stange price/piece		Preis/Stück price/piece	
300 cm	300 cm	100 cm	100 cm
Lagerware	Bestellware	Lagerware	Bestellware
23,26			
17,31			

40202

ESTRICHWINKEL, ungebohrt
SCREED PROFILE, undrilled
40x20x2mm

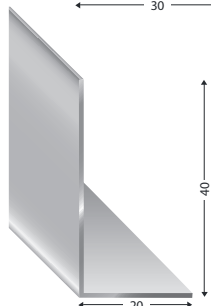

Artikel-Nr. article-no.	Farbe colour	VE unit
40202 S	silber/silver	10
40202 R	roh/raw	10

Preis/Stange price/piece		Preis/Stück price/piece	
300 cm	300 cm	100 cm	100 cm
Lagerware	Bestellware	Lagerware	Bestellware
23,26			
17,31			

40402

ESTRICHWINKEL, ungebohrt
SCREED PROFILE, undrilled
40x40x2mm

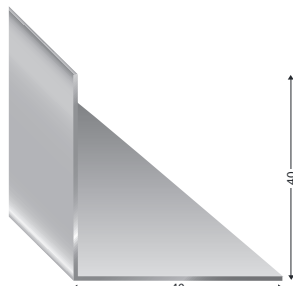

Artikel-Nr. article-no.	Farbe colour	VE unit
40402 S	silber/silver	10
40402 R	roh/raw	10

Preis/Stange price/piece		Preis/Stück price/piece	
300 cm	300 cm	100 cm	100 cm
Lagerware	Bestellware	Lagerware	Bestellware
29,34			
23,32			

50202

ESTRICHWINKEL, ungebohrt
SCREED PROFILE, undrilled
50x20x2mm

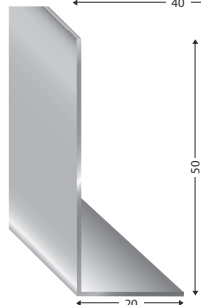

Artikel-Nr. article-no.	Farbe colour	VE unit
50202 S	silber/silver	10
50202 R	roh/raw	10

Preis/Stange price/piece		Preis/Stück price/piece	
300 cm	300 cm	100 cm	100 cm
Lagerware	Bestellware	Lagerware	Bestellware
26,52			
20,57			

50502

ESTRICHWINKEL, ungebohrt
SCREED PROFILE, undrilled
50x50x2mm

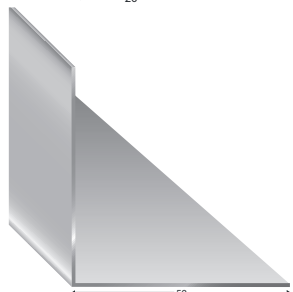

Artikel-Nr. article-no.	Farbe colour	VE unit
50502 S	silber/silver	10
50502 R	roh/raw	10

Preis/Stange price/piece		Preis/Stück price/piece	
300 cm	300 cm	100 cm	100 cm
Lagerware	Bestellware	Lagerware	Bestellware
35,49			
29,53			

60202

ESTRICHWINKEL, ungebohrt
SCREED PROFILE, undrilled
60x20x2mm

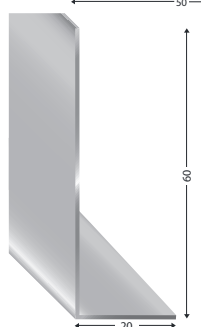

Artikel-Nr. article-no.	Farbe colour	VE unit
60202 S	silber/silver	10
60202 R	roh/raw	10

Preis/Stange price/piece		Preis/Stück price/piece	
300 cm	300 cm	100 cm	100 cm
Lagerware	Bestellware	Lagerware	Bestellware
29,34			
23,32			



Symbolfoto

KONDENSWASSERPROFILE

aus Aluminium

CONDENSATION DRAINAGE PROFILES

in aluminium

66448

KONDENSWASSERPROFIL, ungebohrt
für Türen und Fenster
CONDENSATION DRAINAGE PROFILE, undrilled
for doors and windows

Artikel-Nr. *article-no.* Farbe *colour* VE *unit*

Preis/Stück *price/piece*

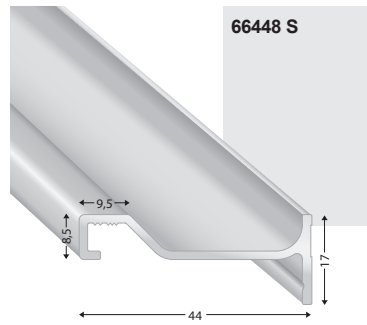
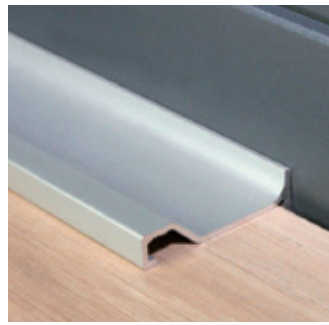

66448 S

silber/silver



10

300 cm		300 cm	
Lagerware	Bestellware	Lagerware	Bestellware
34,99			

1218

KONDENSWASSERPROFIL, selbstklebend
CONDENSATION DRAINAGE PROFILE, self-adhesive

Artikel-Nr. *article-no.* Farbe *colour* VE *unit*

Preis/Stück *price/piece*

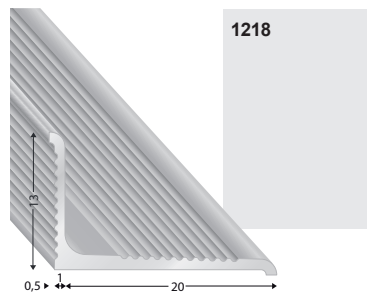

1218

silber/silver



10

270 cm		270 cm	
Lagerware	Bestellware	Lagerware	Bestellware
27,42			

SKL

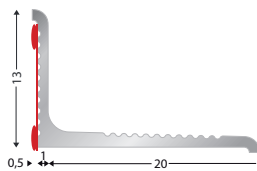

1519

KONDENSWASSERPROFIL, selbstklebend
CONDENSATION DRAINAGE PROFILE, self-adhesive

Artikel-Nr. *article-no.* Farbe *colour* VE *unit*

Preis/Stück *price/piece*

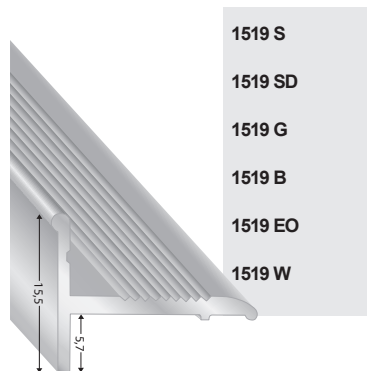

1519 S

silber/silver



10

1519 SD

sand/sand



10

1519 G

gold/gold



10

1519 B

bronze/bronze



10

1519 EO

titan/EO



10

1519 W

weiß/white



10

270 cm		270 cm	
Lagerware	Bestellware	Lagerware	Bestellware
21,07			
			*
			*
			*
21,32			
26,10			

SKL

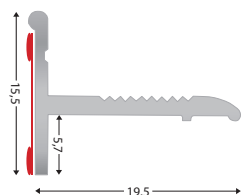

* Preis auf Anfrage / price on request



**GLEITSCHUTZSTREIFEN
EINLAGESTREIFEN**

***ANTI-SLIP
INSERT STRIPS***

FARBKARTE für „as“ - anti-slide

Gleitschutzstreifen mit KORUNDBESCHICHTUNG auf Kunststoffträger, selbstklebend

COLOUR CARD „as“ anti-slide

Corundum coated insert strip, self-adhesive

SELBSTKLEBEND / self-adhesive

FARBKARTE für 12, 1225, 225 und 250
COLOUR CARD for 12, 1225, 225 und 250

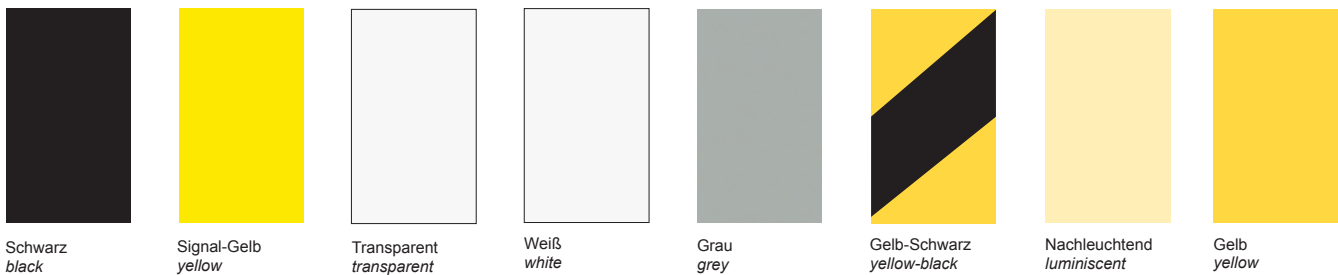

FARBKARTE für Kunststoff Einlagestreifen zu Treppen- und Stiegenkanten

COLOUR CARD for synthetic insert strips for stair-nosings

SELBSTKLEBEND / self-adhesive

FARBKARTE für 20114
COLOUR CARD for 20114



NICHT SELBSTKLEBEND / non adhesive

FARBKARTE für 27 E, 12/3 STP, 40 STP und DL 810
COLOUR CARD for 27 E, 12/3 STP, 40 STP and DL 810

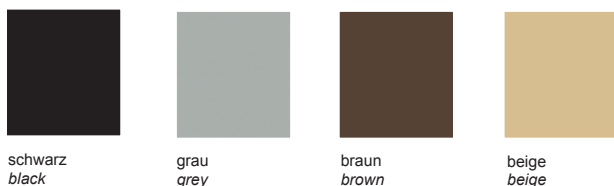

FARBKARTE für 50 ST
COLOUR CARD for 50 ST



3Y

12 SCHWARZ

Kunststoff, Korundbeschichtet, selbstklebend
corundum coated, self-adhesive

12,5 mm

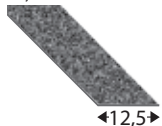

nur schwarz
Länge 18 m, Breite 12,5 mm, Zuschnitt
black only
length 18 m, width 12,5 mm, cut

Artikel-Nr. article-no.	Farbe colour	VE unit	Preis/lfm price/m	Preis/ROLLE price/rolls
12 SCHWARZ	schwarz/black	SW 1	Lagerware: 2,72 Bestellware:	Lagerware: Bestellware:

1225

Kunststoff, Korundbeschichtet, selbstklebend
corundum coated, self-adhesive

25 mm

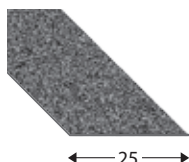

Breite: 25 mm, Zuschnitt
width: 25 mm, cut

Artikel-Nr. article-no.	Farbe colour	VE unit	Preis/lfm price/m	Preis/ROLLE price/rolls
1225 N	N	1	Lagerware: 7,52 Bestellware:	Lagerware: Bestellware:
1225 SIGGELB	SG	1	5,48	
1225 GELB	G	1	5,48	
1225 GRAU	G	1	5,48	
1225 GELBSCHW	SG	1	5,48	
1225 SCHWARZ	SW	1	5,48	
1225 TRANSP	T	1	5,48	
1225 WEISS	W	1	5,48	

225

Kunststoff, Korundbeschichtung, selbstklebend
corundum coated, self-adhesive

25 mm

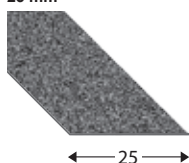

Länge 18 m, Breite 25 mm
nur in kompletten Rollen
length: 18 m, width: 50 mm
complete rolls only

Artikel-Nr. article-no.	Farbe colour	VE unit	Preis/lfm price/m	Preis/ROLLE price/rolls
225 N	N	1	Lagerware: Bestellware:	Lagerware: 114,82 Bestellware:
225 SIGGELB	SG	1		81,95
225 GELB	G	1		81,95
225 GRAU	G	1		81,95
225 GELBSCHW	SG	1		81,95
225 SCHWARZ	SW	1		81,95
225 TRANSP	T	1		81,95
225 WEISS	W	1		81,95

250

Kunststoff, Korundbeschichtung, selbstklebend
corundum coated, self-adhesive

50 mm

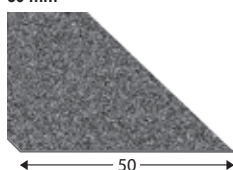

Länge 18 m, Breite 50 mm
nur in kompletten Rollen
length: 18 m, width: 50 mm
complete rolls only

Artikel-Nr. article-no.	Farbe colour	VE unit	Preis/lfm price/m	Preis/ROLLE price/rolls
250 SIGGELB	SG	1	Lagerware: Bestellware:	Lagerware: 163,94 Bestellware:
250 GELB	G	1		163,94
250 GRAU	G	1		163,94
250 GELBSCHW	SG	1		163,94
250 SCHWARZ	SW	1		163,94
250 TRANSP	T	1		163,94
250 WEISS	W	1		163,94

20114

Kunststoff, selbstklebend
Synthetic, self-adhesive

12 mm

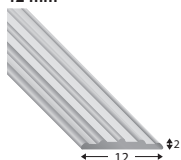

Länge 25 m, Breite 12 mm, ZUSCHNITT
fein gerillt
length 25 m, width 12 mm, cut-service
finely-grooved

Um 2% länger zuschneiden und verkleben!
Cut 2% longer and glue!

Artikel-Nr. article-no.	Farbe colour	VE unit	Preis/lfm price/m	Preis/ROLLE price/rolls
20114 SCHW	SW	1	Lagerware: 2,11 Bestellware:	Lagerware: Bestellware:
20114 GRAU	G	1	2,11	

27 E

Kunststoff, nicht selbstklebend

Synthetic, non adhesive

27 mm

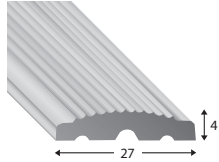

Länge 25 m, Breite 27 mm, ZUSCHNITT
length 25 m, width 27 mm, cut-service

Um 2% länger zuschneiden und verkleben!
Cut 2% longer and glue!

Artikel-Nr. article-no.	Farbe colour	VE unit	Preis/lfm price/m	Preis/ROLLE price/rolls
27 E SCHWARZ	schwarz/black	1	3,32	
27 E GRAU	grau/grey	1	3,32	
27 E BRAUN	braun/brown	1	3,32	
27 E BEIGE	beige/beige	1	3,32	

50 ST

Kunststoff, nicht selbstklebend

Synthetic, non adhesive

49 mm

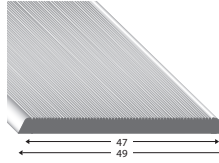

Länge 25 m, Breite 49 mm, ZUSCHNITT
length 25 m, width 49 mm, cut-service

Um 2% länger zuschneiden und verkleben!
Cut 2% longer and glue!

Artikel-Nr. article-no.	Farbe colour	VE unit	Preis/lfm price/m	Preis/ROLLE price/rolls
50 ST ANTHR	anthrazit	1	6,23	
50 ST HGRAU	hellgrau/ light grey	1	6,23	

12/3 STP

Kunststoff, nicht selbstklebend

Synthetic, non adhesive

12,4 mm

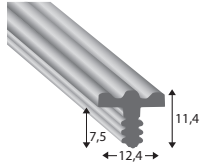

Länge 25 m
Höhe 7,5 mm und 11,5 mm
Breite 12,4 mm
length 25 m

height 7,5 mm and 11,5 mm
width 12,4 mm

zum Einfräsen, Frästiefe 8 mm
to be inserted in a gouged out groove,
milling depth 8 mm

nur in kompletten Rollen / only in complete rolls

Um 2% länger zuschneiden und verkleben!
Cut 2% longer and glue!

Artikel-Nr. article-no.	Farbe colour	VE unit	Preis/lfm price/m	Preis/ROLLE price/rolls
12/3 STP G10	schwarz/black	1		122,79
12/3 STP G21	grau/grey	1		122,79
12/3 STP D11	braun/brown	1		122,79
12/3 STP M18	beige/beige	1		122,79

40 STP

Kunststoff, nicht selbstklebend

Synthetic, non adhesive

40 mm

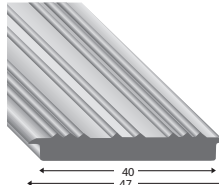

Länge 25 m, Breite 40 mm
length 25 m, width 40 mm

zum Einfräsen, Frästiefe 3,5 mm, Überstand 4 mm
to be inserted in a gouged out groove,
milling depth 3,5 mm, overlapping lip 4 mm

nur in kompletten Rollen / only in complete rolls

Um 2% länger zuschneiden und verkleben!
Cut 2% longer and glue!

Artikel-Nr. article-no.	Farbe colour	VE unit	Preis/lfm price/m	Preis/ROLLE price/rolls
40 STP G10	schwarz/black	1		382,47
40 STP G21	grau/grey	1		382,47
40 STP D11	braun/brown	1		382,47
40 STP M18	beige/beige	1		382,47

DL 810

Dichtlippe zu Profil 3515 DL

Sealing-lip to profile 3515 DL

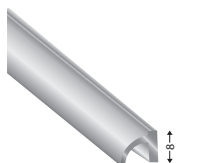

Länge 30 m
length 30 m

Artikel-Nr. article-no.	Farbe colour	VE unit	Preis/lfm price/m	Preis/ROLLE price/rolls
DL 810 SR	schwarz/black	1	2,03	
DL 810 GR	grau/grey	1	2,03	



Symbolfoto

RENO
TREPPENRENOVIERUNGSPROFILE
aus Aluminium

RENO
STAIR RENOVATION PROFILES
in aluminium

79-120803

RENO Grundprofil All in One
RENO base profile All in One

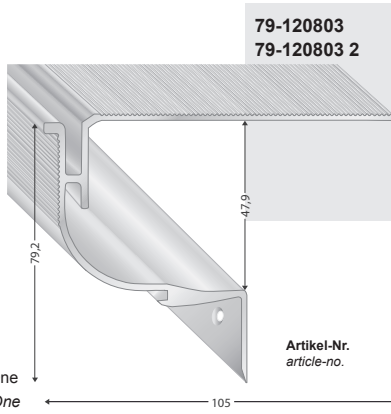
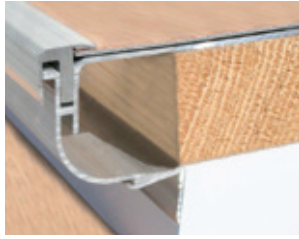

Artikel-Nr.
79-120803
79-120803 2

Farbe
roh/raw
roh/raw



VE
unit
4
4

Preis/Stange price/piece		Preis/Stück price/piece	
270 cm	270 cm	200 cm	200 cm
Lagerware	Bestellware	Lagerware	Bestellware
			*

Preis/Stange price/piece		Preis/Stück price/piece	
270 cm	270 cm	200 cm	200 cm
Lagerware	Bestellware	Lagerware	Bestellware
			*

79-010121

RENO Kopfprofil für Grundprofil All in One
RENO cover profile for base profile All in One

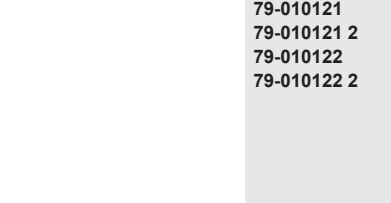
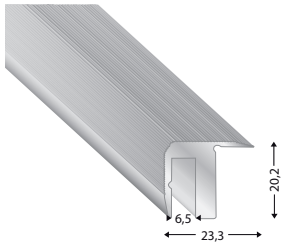

Artikel-Nr.
79-010121
79-010121 2
79-010122
79-010122 2

Farbe
silber/silver
gold/gold



VE
unit
4
4

Preis/Stange price/piece		Preis/Stück price/piece	
270 cm	270 cm	200 cm	200 cm
Lagerware	Bestellware	Lagerware	Bestellware
	*		*

Preis/Stange price/piece		Preis/Stück price/piece	
270 cm	270 cm	200 cm	200 cm
Lagerware	Bestellware	Lagerware	Bestellware
			*

79-110851

RENO Treppenprofil Standard
RENO Stair nosing profile Standard
8,5 mm

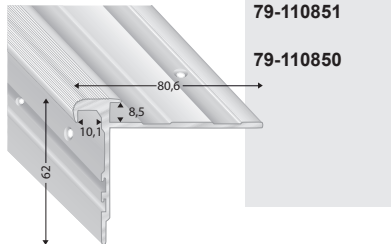

Artikel-Nr.
79-110851
79-110850

Farbe
silber/silver
gold/gold



VE
unit
4
4

Preis/Stange price/piece		Preis/Stück price/piece	
270 cm	270 cm	200 cm	200 cm
Lagerware	Bestellware	Lagerware	Bestellware
	*		*

Preis/Stange price/piece		Preis/Stück price/piece	
270 cm	270 cm	200 cm	200 cm
Lagerware	Bestellware	Lagerware	Bestellware
			*

79-13250

RENO Treppenprofil Multiversal
RENO Stair nosing profile Multiversal

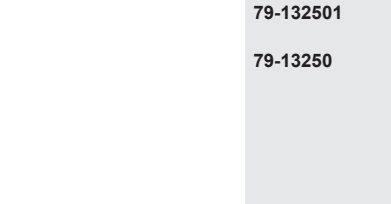
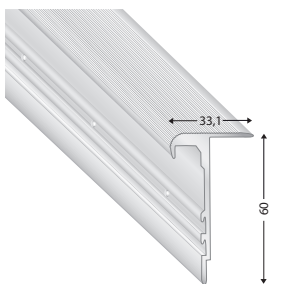

Artikel-Nr.
79-132501
79-13250

Farbe
silber/silver
gold/gold



VE
unit
4
4

Preis/Stange price/piece		Preis/Stück price/piece	
270 cm	270 cm	200 cm	200 cm
Lagerware	Bestellware	Lagerware	Bestellware
	*		*

Preis/Stange price/piece		Preis/Stück price/piece	
270 cm	270 cm	200 cm	200 cm
Lagerware	Bestellware	Lagerware	Bestellware
			*

79-120851

RENO Treppenprofil Stabil
RENO Stair nosing profile Stabil
8,5 mm

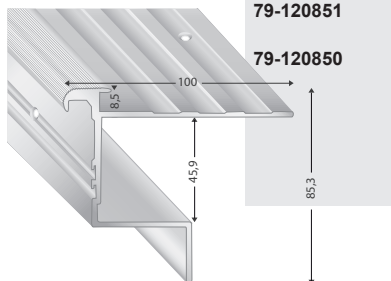

Artikel-Nr.
79-120851
79-120850

Farbe
silber/silver
gold/gold



VE
unit
4
4

Preis/Stange price/piece		Preis/Stück price/piece	
270 cm	270 cm	200 cm	200 cm
Lagerware	Bestellware	Lagerware	Bestellware
	*		*

Preis/Stange price/piece		Preis/Stück price/piece	
270 cm	270 cm	200 cm	200 cm
Lagerware	Bestellware	Lagerware	Bestellware
			*

* Preis auf Anfrage / price on request

79-D653

RENO Treppenprofil
RENO Stair nosing profile
3,1 mm

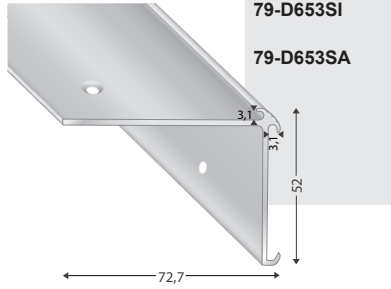

Artikel-Nr. article-no.	Farbe colour	VE unit
79-D653SI	silber/silver	4
79-D653SA	sand/sand	4

Preis/Stange price/piece		Preis/Stück price/piece	
270 cm	270 cm	200 cm	200 cm
Lagerware	Bestellware	Lagerware	Bestellware
	*		*

79-D675

RENO Treppenprofil
RENO Stair nosing profile

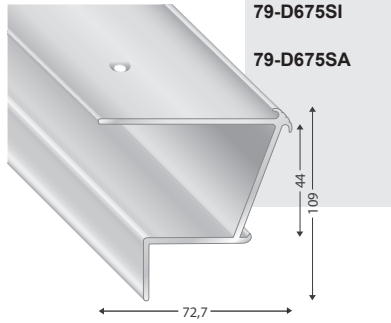

Artikel-Nr. article-no.	Farbe colour	VE unit
79-D675SI	silber/silver	4
79-D675SA	sand/sand	4

Preis/Stange price/piece		Preis/Stück price/piece	
270 cm	270 cm	200 cm	200 cm
Lagerware	Bestellware	Lagerware	Bestellware
	*		*

79-D654

RENO Treppenprofil
RENO Stair nosing profile
4,1 mm



Artikel-Nr. article-no.	Farbe colour	VE unit
79-D654SI	silber/silver	4
79-D654SA	sand/sand	4

Preis/Stange price/piece		Preis/Stück price/piece	
270 cm	270 cm	200 cm	200 cm
Lagerware	Bestellware	Lagerware	Bestellware
	*		*

79-D656

RENO Treppenprofil
RENO Stair nosing profile
6,1 mm



Artikel-Nr. article-no.	Farbe colour	VE unit
79-D656SI	silber/silver	4
79-D656SA	sand/sand	4

Preis/Stange price/piece		Preis/Stück price/piece	
270 cm	270 cm	200 cm	200 cm
Lagerware	Bestellware	Lagerware	Bestellware
	*		*

79-10050

RENO Treppenprofil
RENO Stair nosing profile

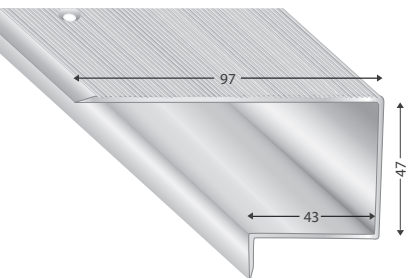

Artikel-Nr. article-no.	Farbe colour	VE unit
79-10050	silber/silver	4
79-10050 2		4

Preis/Stange price/piece		Preis/Stück price/piece	
270 cm	270 cm	200 cm	200 cm
Lagerware	Bestellware	Lagerware	Bestellware
	*		*

* Preis auf Anfrage / price on request



FLIESENPROFILE

aus Aluminium und Kunststoff

PROFILES FOR CERAMIC TILES

in aluminium and synthetic

119 2
FLIESENPROFIL „PRIMO“ in Aluminium
 PROFILE FOR CERAMIC TILES „PRIMO“ in aluminium
 Innenhöhe / inner-height 2 mm

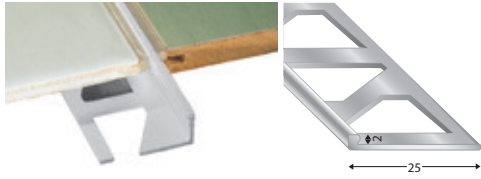

Artikel-Nr. article-no.	Farbe colour	VE unit
119 2 S 3	silber/silver	10
119 2 R 3	roh/raw	10

Preis/Stange price/piece	
300 cm	300 cm
Lagerware	Bestellware
12,79	
11,35	

119 2,5
FLIESENPROFIL „PRIMO“ in Aluminium
 PROFILE FOR CERAMIC TILES „PRIMO“ in aluminium
 Innenhöhe / inner-height 2,5 mm

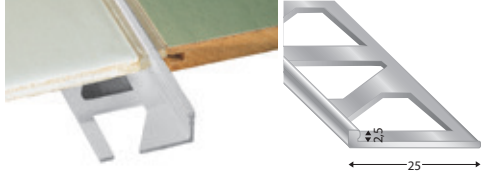

Artikel-Nr. article-no.	Farbe colour	VE unit
119 2,5 S 3	silber/silver	10
119 2,5 R 3	roh/raw	10

Preis/Stange price/piece	
300 cm	300 cm
Lagerware	Bestellware
16,30	
11,35	

119 3
FLIESENPROFIL „PRIMO“ in Aluminium
 PROFILE FOR CERAMIC TILES „PRIMO“ in aluminium
 Innenhöhe / inner-height 3 mm

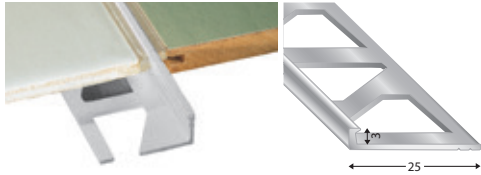

Artikel-Nr. article-no.	Farbe colour	VE unit
119 3 S 3	silber/silver	10
119 3 R 3	roh/raw	10

Preis/Stange price/piece	
300 cm	300 cm
Lagerware	Bestellware
18,50	
14,48	

119 4,5
FLIESENPROFIL „PRIMO“ in Aluminium
 PROFILE FOR CERAMIC TILES „PRIMO“ in aluminium
 Innenhöhe / inner-height 4,5 mm

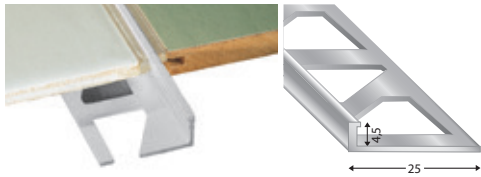

Artikel-Nr. article-no.	Farbe colour	VE unit
119 4,5 S 3	silber/silver	10
119 4,5 R 3	roh/raw	10

Preis/Stange price/piece	
300 cm	300 cm
Lagerware	Bestellware
20,38	
14,99	

119 6
FLIESENPROFIL „PRIMO“ in Aluminium
 PROFILE FOR CERAMIC TILES „PRIMO“ in aluminium
 Innenhöhe / inner-height 6 mm

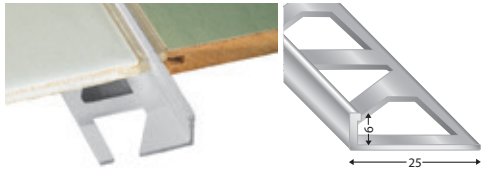

Artikel-Nr. article-no.	Farbe colour	VE unit
119 6 S 3	silber/silver	10
119 6 ROH 3	roh/raw	10
119 6 W 3	weiß/white	10

Preis/Stange price/piece	
300 cm	300 cm
Lagerware	Bestellware
21,88	
16,18	
	*

119 8
FLIESENPROFIL „PRIMO“ in Aluminium
 PROFILE FOR CERAMIC TILES „PRIMO“ in aluminium
 Innenhöhe / inner-height 8 mm

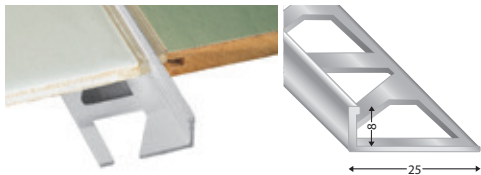

Artikel-Nr. article-no.	Farbe colour	VE unit
119 8 S 3	silber/silver	10
119 8 ROH 3	roh/raw	10
119 8 W 3	weiß/white	10

Preis/Stange price/piece	
300 cm	300 cm
Lagerware	Bestellware
22,01	
17,31	
	*

119 10
FLIESENPROFIL „PRIMO“ in Aluminium
 PROFILE FOR CERAMIC TILES „PRIMO“ in aluminium
 Innenhöhe / inner-height 10 mm

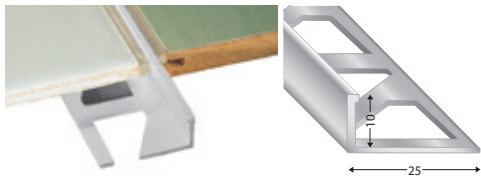

Artikel-Nr. article-no.	Farbe colour	VE unit
119 10 S 3	silber/silver	10
119 10 ROH 3	roh/raw	10
119 10 W 3	weiß/white	10

Preis/Stange price/piece	
300 cm	300 cm
Lagerware	Bestellware
22,20	
18,50	
	*

* Preis auf Anfrage / price on request

119 11

FLIESENPROFIL „PRIMO“ in Aluminium
 PROFILE FOR CERAMIC TILES „PRIMO“ in aluminium
 Innenhöhe / inner-height 11 mm

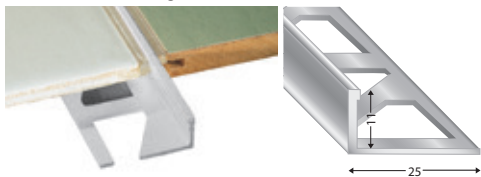

Artikel-Nr. article-no.	Farbe colour		VE unit
119 11 S 3	silber/silver	S	10
119 11 ROH 3	roh/raw	R	10
119 11 W 3	weiß/white	W	10

Preis/Stange price/piece	
300 cm	300 cm
Lagerware	Bestellware
22,76	
19,06	*

5A

119 12

FLIESENPROFIL „PRIMO“ in Aluminium
 PROFILE FOR CERAMIC TILES „PRIMO“ in aluminium
 Innenhöhe / inner-height 12,5 mm

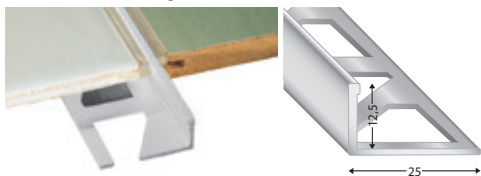

Artikel-Nr. article-no.	Farbe colour		VE unit
119 12 S 3	silber/silver	S	10
119 12 ROH 3	roh/raw	R	10
119 12 W 3	weiß/white	W	10

Preis/Stange price/piece	
300 cm	300 cm
Lagerware	Bestellware
23,26	
19,75	*

119 15

FLIESENPROFIL „PRIMO“ in Aluminium
 PROFILE FOR CERAMIC TILES „PRIMO“ in aluminium
 Innenhöhe / inner-height 15 mm

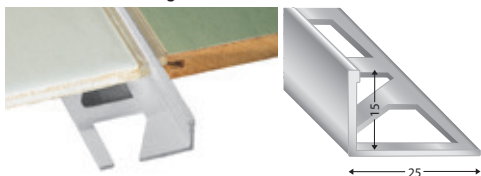

Artikel-Nr. article-no.	Farbe colour		VE unit
119 15 S 3	silber/silver	S	10
119 15 ROH 3	roh/raw	R	10

Preis/Stange price/piece	
300 cm	300 cm
Lagerware	Bestellware
24,33	
20,69	*

119 18

FLIESENPROFIL „PRIMO“ in Aluminium
 PROFILE FOR CERAMIC TILES „PRIMO“ in aluminium
 Innenhöhe / inner-height 18 mm



Artikel-Nr. article-no.	Farbe colour		VE unit
119 18 S 3	silber/silver	S	10
119 18 ROH 3	roh/raw	R	10

Preis/Stange price/piece	
300 cm	300 cm
Lagerware	Bestellware
30,16	
22,57	

119 20

FLIESENPROFIL „PRIMO“ in Aluminium
 PROFILE FOR CERAMIC TILES „PRIMO“ in aluminium
 Innenhöhe / inner-height 20 mm

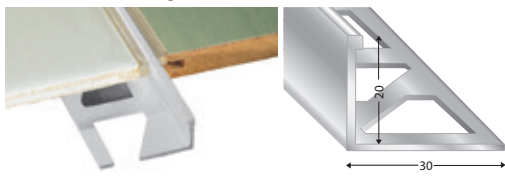

Artikel-Nr. article-no.	Farbe colour		VE unit
119 20 S 3	silber/silver	S	10
119 20 ROH 3	roh/raw	R	10

Preis/Stange price/piece	
300 cm	300 cm
Lagerware	Bestellware
33,11	
27,21	

119 22

FLIESENPROFIL „PRIMO“ in Aluminium
 PROFILE FOR CERAMIC TILES „PRIMO“ in aluminium
 Innenhöhe / inner-height 22,5 mm

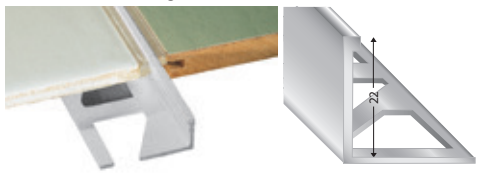

Artikel-Nr. article-no.	Farbe colour		VE unit
119 22 S 3	silber/silver	S	10
119 22 ROH 3	roh/raw	R	10

Preis/Stange price/piece	
300 cm	300 cm
Lagerware	Bestellware
35,80	
29,59	

* Preis auf Anfrage / price on request

5A

122 6
FLIESENPROFIL „DOPPIO“ in Aluminium
PROFILE FOR CERAMIC TILES „DOPPIO“ in aluminium
 Innenhöhe / inner-height 6 mm

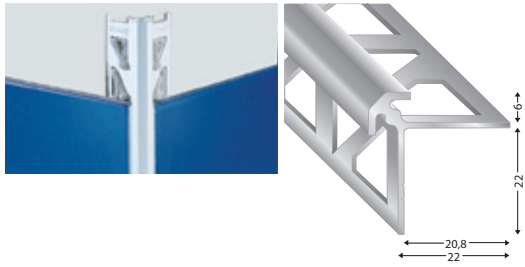

Artikel-Nr. article-no.	Farbe colour	VE unit
122 6 S 3	silber/silver	S 10

Preis/Stück price/piece	
300 cm	300 cm
Lagerware	Bestellware
42,67	

122 8
FLIESENPROFIL „DOPPIO“ in Aluminium
PROFILE FOR CERAMIC TILES „DOPPIO“ in aluminium
 Innenhöhe / inner-height 8 mm

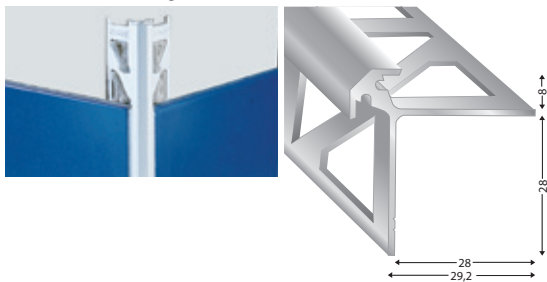

Artikel-Nr. article-no.	Farbe colour	VE unit
122 8 S 3	silber/silver	S 10

Preis/Stück price/piece	
300 cm	300 cm
Lagerware	Bestellware
45,52	

122 11
FLIESENPROFIL „DOPPIO“ in Aluminium
PROFILE FOR CERAMIC TILES „DOPPIO“ in aluminium
 Innenhöhe / inner-height 11 mm

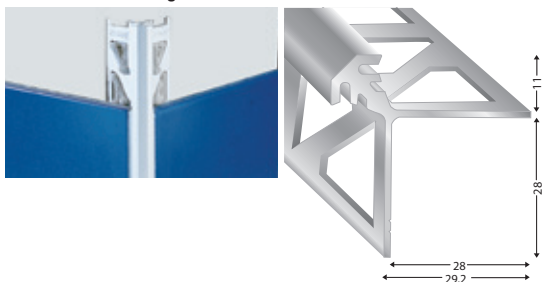

Artikel-Nr. article-no.	Farbe colour	VE unit
122 11 S 3	silber/silver	S 10

Preis/Stück price/piece	
300 cm	300 cm
Lagerware	Bestellware
55,24	

218 6
FLIESENPROFIL „RONDO“ in Aluminium
PROFILE FOR CERAMIC TILES „RONDO“ in aluminium
 Innenhöhe / inner-height 6 mm



Artikel-Nr. article-no.	Farbe colour	VE unit
218 6 S 3	silber/silver	10

Preis/Stück price/piece	
300 cm	300 cm
Lagerware	Bestellware
18,77	

218 8
FLIESENPROFIL „RONDO“ in Aluminium
PROFILE FOR CERAMIC TILES „RONDO“ in aluminium
 Innenhöhe / inner-height 8 mm

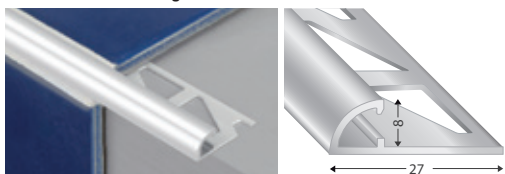

Artikel-Nr. article-no.	Farbe colour	VE unit
218 8 S 3	silber/silver	10

Preis/Stück price/piece	
300 cm	300 cm
Lagerware	Bestellware
21,59	

218 10
FLIESENPROFIL „RONDO“ in Aluminium
PROFILE FOR CERAMIC TILES „RONDO“ in aluminium
 Innenhöhe / inner-height 10 mm

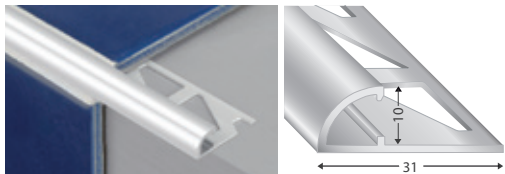

Artikel-Nr. article-no.	Farbe colour	VE unit
218 10 S 3	silber/silver	10

Preis/Stück price/piece	
300 cm	300 cm
Lagerware	Bestellware
23,85	

218 12,5
FLIESENPROFIL „RONDO“ in Aluminium
PROFILE FOR CERAMIC TILES „RONDO“ in aluminium
 Innenhöhe / inner-height 12,5 mm



Artikel-Nr. article-no.	Farbe colour	VE unit
218 12,5 S 3	silber/silver	10

Preis/Stück price/piece	
300 cm	300 cm
Lagerware	Bestellware
27,80	

217 7

FLIESENPROFIL „QUADRA“ in Aluminium
PROFILE FOR CERAMIC TILES „QUADRA“ in aluminium
 Innenhöhe / inner-height 7 mm

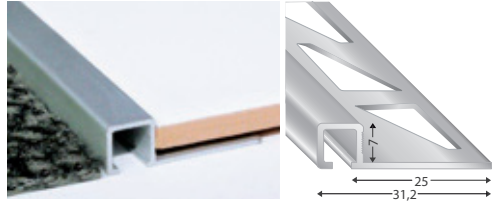

Artikel-Nr. article-no.	Farbe colour	VE unit
217 7 S 3	silber/silver	10
217 7 W 3	weiß/white	10

Preis/Stange price/piece	
300 cm	300 cm
Lagerware	Bestellware
21,72	*

217 9

FLIESENPROFIL „QUADRA“ in Aluminium
PROFILE FOR CERAMIC TILES „QUADRA“ in aluminium
 Innenhöhe / inner-height 9 mm

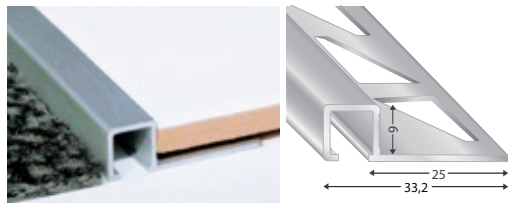

Artikel-Nr. article-no.	Farbe colour	VE unit
217 9 S 3	silber/silver	10
217 9 W 3	weiß/white	10

Preis/Stange price/piece	
300 cm	300 cm
Lagerware	Bestellware
23,97	*

217 11

FLIESENPROFIL „QUADRA“ in Aluminium
PROFILE FOR CERAMIC TILES „QUADRA“ in aluminium
 Innenhöhe / inner-height 11 mm

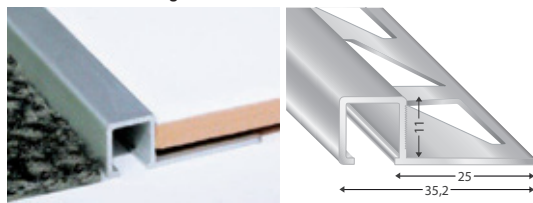

Artikel-Nr. article-no.	Farbe colour	VE unit
217 11 S 3	silber/silver	10
217 11 W 3	weiß/white	10

Preis/Stange price/piece	
300 cm	300 cm
Lagerware	Bestellware
25,02	*

217 13

FLIESENPROFIL „QUADRA“ in Aluminium
PROFILE FOR CERAMIC TILES „QUADRA“ in aluminium
 Innenhöhe / inner-height 13 mm

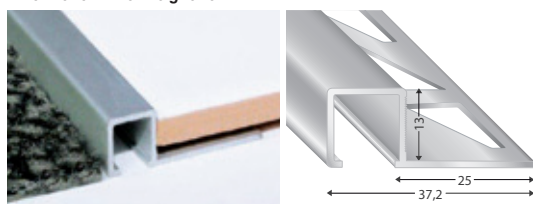

Artikel-Nr. article-no.	Farbe colour	VE unit
217 13 S 3	silber/silver	10
217 13 W 3	weiß/white	10

Preis/Stange price/piece	
300 cm	300 cm
Lagerware	Bestellware
28,44	*

SANI 11

Sanitär-Hohlkehlenprofil in Aluminium
Sanitary concave profile in aluminium
 Innenhöhe / inner-height 11 mm

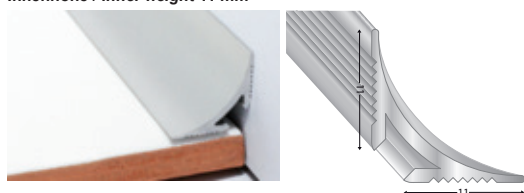

Artikel-Nr. article-no.	Farbe colour	VE unit
SANI 11 S	silber/silver	10
SANI 11 W	weiß/white (RAL 9016)	10

Preis/Stange price/piece	
300 cm	300 cm
Lagerware	Bestellware
13,54	
21,44	

* Preis auf Anfrage / price on request

5A

121 B 10

FLIESENPROFIL „STAIR“ in Aluminium
PROFILES FOR CERAMIC TILES „STAIR“ in aluminium
Innenhöhe / inner-height 10 mm

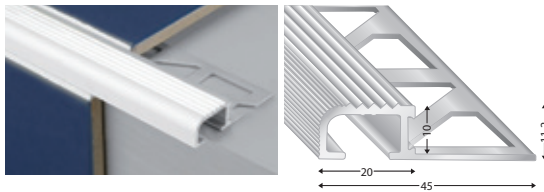

Artikel-Nr. article-no.	Farbe colour	VE unit
121 B 10 S 3	silber/silver	S 10

Preis/Stange price/piece	
300 cm	300 cm
Lagerware	Bestellware
35,80	

5A

121 B 12

FLIESENPROFIL „STAIR“ in Aluminium
PROFILE FOR CERAMIC TILES „STAIR“ in aluminium
Innenhöhe / inner-height 12 mm

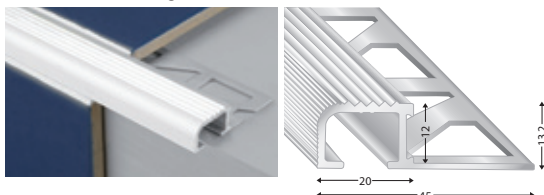

Artikel-Nr. article-no.	Farbe colour	VE unit
121 B 12 S 3	silber/silver	S 10

Preis/Stange price/piece	
300 cm	300 cm
Lagerware	Bestellware
37,24	

121 A 10

FLIESENPROFIL „DUE“ in Aluminium
PROFILE FOR CERAMIC TILES „DUE“ in aluminium
Innenhöhe / inner-height 10 mm

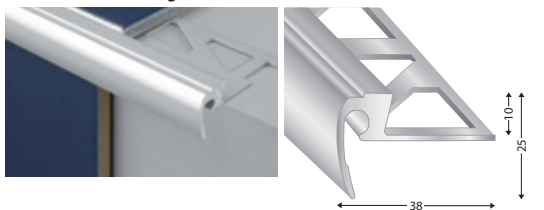

Artikel-Nr. article-no.	Farbe colour	VE unit
121 A 10 S 3	silber/silver	S 10

Preis/Stange price/piece	
300 cm	300 cm
Lagerware	Bestellware
53,36	

121 A 12

FLIESENPROFIL „DUE“ in Aluminium
PROFILE FOR CERAMIC TILES „DUE“ in aluminium
Innenhöhe / inner-height 12 mm

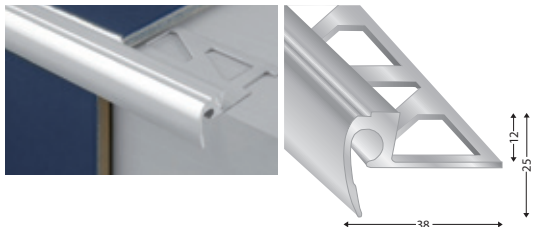

Artikel-Nr. article-no.	Farbe colour	VE unit
121 A 12 S 3	silber/silver	S 10

Preis/Stange price/piece	
300 cm	300 cm
Lagerware	Bestellware
	*

121 10

FLIESENPROFIL „DUE“ in Aluminium, ohne Einlagestreifen Art. 27 E
PROFILE FOR CERAMIC TILES „DUE“ in aluminium, without insert strip Art. 27 E
Innenhöhe / inner-height 10 mm

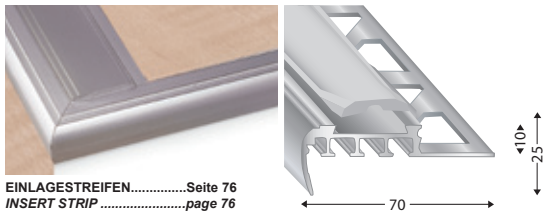

EINLAGESTREIFEN.....Seite 76
 INSERT STRIPpage 76

Artikel-Nr. article-no.	Farbe colour	VE unit
121 10 S 3	silber/silver	S 10

Preis/Stange price/piece	
300 cm	300 cm
Lagerware	Bestellware
72,23	

121 12

FLIESENPROFIL „DUE“ in Aluminium, ohne Einlagestreifen Art. 27 E
PROFILE FOR CERAMIC TILES „DUE“ in aluminium, without insert strip Art. 27 E
Innenhöhe / inner-height 12 mm

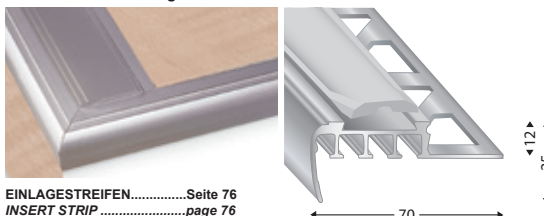

EINLAGESTREIFEN.....Seite 76
 INSERT STRIPpage 76

Artikel-Nr. article-no.	Farbe colour	VE unit
121 12 S 3	silber/silver	S 10

Preis/Stange price/piece	
300 cm	300 cm
Lagerware	Bestellware
	*

* Preis auf Anfrage / price on request

5A

1340 8
FLIESENPROFIL „FINALE“ in Aluminium
 PROFILE FOR CERAMIC TILES „FINALE“ in aluminium
 Innenhöhe / inner-height 8 mm

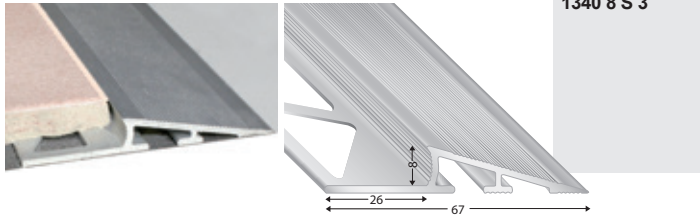

Artikel-Nr. article-no.	Farbe colour	VE unit
1340 8 S 3	silber/silver	S 10

Preis/Stange price/piece	
300 cm	300 cm
Lagerware	Bestellware
38,75	

1340 10
FLIESENPROFIL „FINALE“ in Aluminium
 PROFILE FOR CERAMIC TILES „FINALE“ in aluminium
 Innenhöhe / inner-height 10 mm

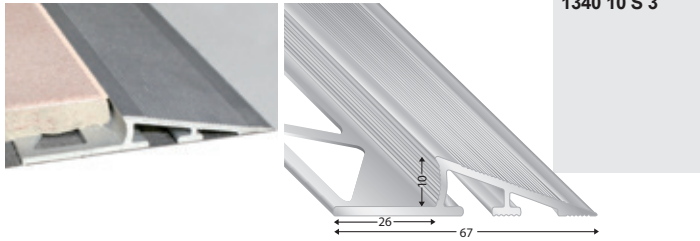

Artikel-Nr. article-no.	Farbe colour	VE unit
1340 10 S 3	silber/silver	S 10

Preis/Stange price/piece	
300 cm	300 cm
Lagerware	Bestellware
43,01	

1340 12
FLIESENPROFIL „FINALE“ in Aluminium
 PROFILE FOR CERAMIC TILES „FINALE“ in aluminium
 Innenhöhe / inner-height 12 mm

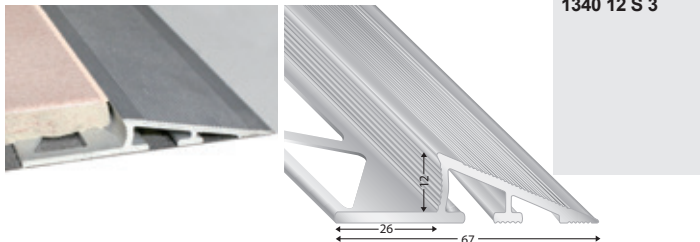

Artikel-Nr. article-no.	Farbe colour	VE unit
1340 12 S 3	silber/silver	S 10

Preis/Stange price/piece	
300 cm	300 cm
Lagerware	Bestellware
48,28	

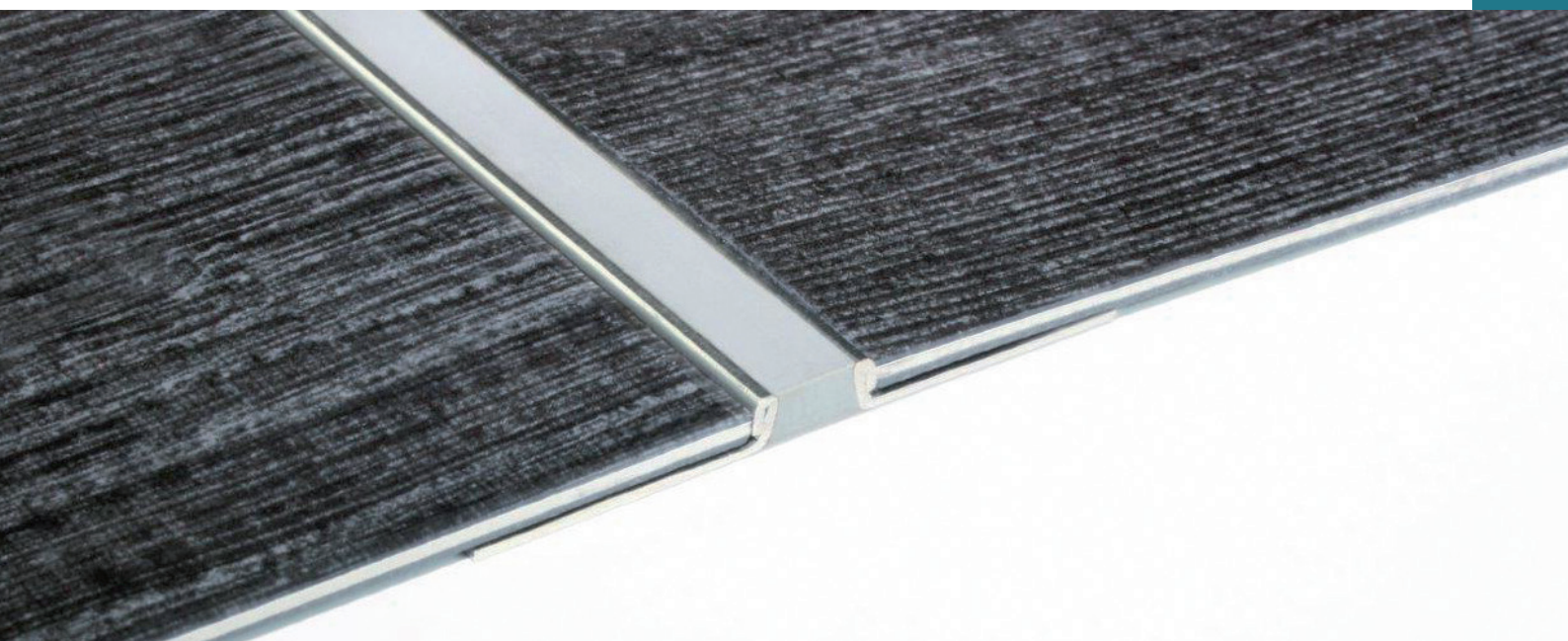

BEWEGUNGSFUGEN

in Aluminium und Kunststoff

EXPANSION JOINTS

in aluminium and synthetic

DF 119 3

BEWEGUNGSFUGE in Aluminium, roh
EXPANSION JOINT in aluminium, raw
 Höhen bis / heights up to 3 mm

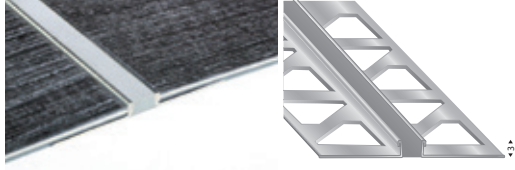

Artikel-Nr. article-no.	Fugenfarbe joint colour	VE unit
DF119 3 R	grau/grey	10
DF119 3 R SW	schwarz/black	10

Preis/Stange price/piece	
300 cm	300 cm
Lagerware	Bestellware
113,47	
113,47	

DF 119 4,5

BEWEGUNGSFUGE in Aluminium, roh
EXPANSION JOINT in aluminium, raw
 Höhen bis / heights up to 4,5 mm

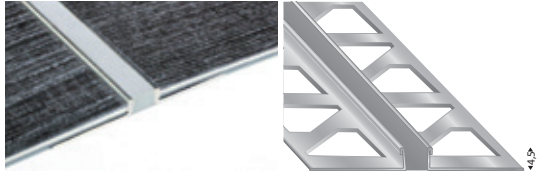

Artikel-Nr. article-no.	Fugenfarbe joint colour	VE unit
DF119 4,5 R	grau/grey	10
DF119 4,5 R SW	schwarz/black	10

Preis/Stange price/piece	
300 cm	300 cm
Lagerware	Bestellware
114,36	
114,36	

DF 119 6

BEWEGUNGSFUGE in Aluminium, roh
EXPANSION JOINT in aluminium, raw
 Höhen bis / heights up to 6 mm

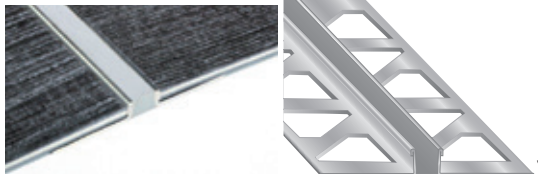

Artikel-Nr. article-no.	Fugenfarbe joint colour	VE unit
DF119 6 R	grau/grey	10
DF119 6 R SW	schwarz/black	10

Preis/Stange price/piece	
300 cm	300 cm
Lagerware	Bestellware
116,75	
116,75	

DF 119 8

BEWEGUNGSFUGE in Aluminium, roh
EXPANSION JOINT in aluminium, raw
 Höhen bis / heights up to 8 mm

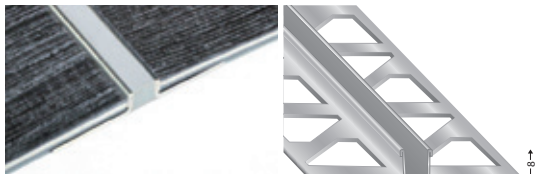

Artikel-Nr. article-no.	Fugenfarbe joint colour	VE unit
DF119 8 R	grau/grey	10
DF119 8 R SW	schwarz/black	10

Preis/Stange price/piece	
300 cm	300 cm
Lagerware	Bestellware
122,01	
122,01	

DF 119 10

BEWEGUNGSFUGE in Aluminium, roh
EXPANSION JOINT in aluminium, raw
 Höhen bis / heights up to 10 mm

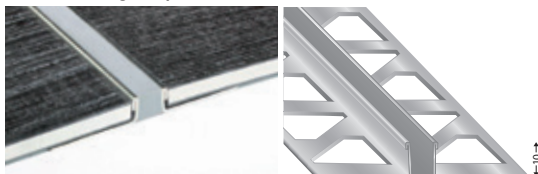

Artikel-Nr. article-no.	Fugenfarbe joint colour	VE unit
DF119 10 R	grau/grey	10
DF119 10 RSW	schwarz/black	10

Preis/Stange price/piece	
300 cm	300 cm
Lagerware	Bestellware
127,93	
127,93	

DF 119 12

BEWEGUNGSFUGE in Aluminium, roh
EXPANSION JOINT in aluminium, raw
 Höhen bis / heights up to 12,5 mm

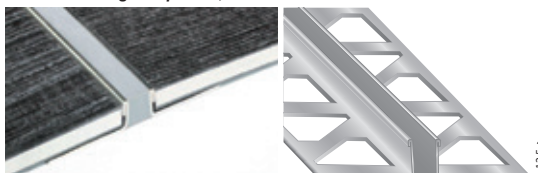

Artikel-Nr. article-no.	Fugenfarbe joint colour	VE unit
DF119 12 R	grau/grey	10

Preis/Stange price/piece	
300 cm	300 cm
Lagerware	Bestellware
137,12	

DF 119 15

BEWEGUNGSFUGE in Aluminium, roh
EXPANSION JOINT in aluminium, raw
 Höhen bis / heights up to 15 mm

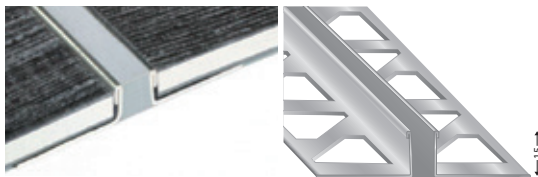

Artikel-Nr. article-no.	Fugenfarbe joint colour	VE unit
DF119 15 R	grau/grey	10

Preis/Stange price/piece	
300 cm	300 cm
Lagerware	Bestellware
147,66	

5B

DF 119 18

BEWEGUNGSFUGE in Aluminium, roh
EXPANSION JOINT in aluminium, raw
 Höhen bis / heights up to 18 mm



Artikel-Nr. article-no.	Fugenfarbe joint colour	VE unit
DF119 18 R	grau/grey	10

Preis/Stange price/piece	
300 cm	300 cm
Lagerware	Bestellware
162,46	

DF 119 20

BEWEGUNGSFUGE in Aluminium, roh
EXPANSION JOINT in aluminium, raw
 Höhen bis / heights up to 20 mm



Artikel-Nr. article-no.	Fugenfarbe joint colour	VE unit
DF119 20 R	grau/grey	10

Preis/Stange price/piece	
300 cm	300 cm
Lagerware	Bestellware
180,87	

DF603

BEWEGUNGSFUGE in Kunststoff
EXPANSION JOINT in synthetic
 Höhen bis / heights up to 3 mm

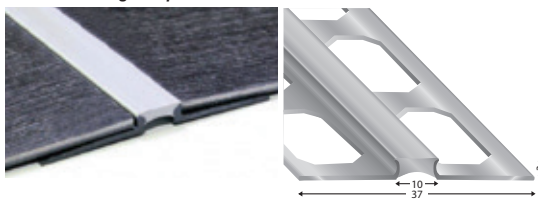

Artikel-Nr. article-no.	Fugenfarbe joint colour	VE unit
DF603 GRAU	grau/grey	10

Preis/Stange price/piece	
270 cm	270 cm
Lagerware	Bestellware
14,04	

DF604

BEWEGUNGSFUGE in Kunststoff
EXPANSION JOINT in synthetic
 Höhen bis / heights up to 4,5 mm

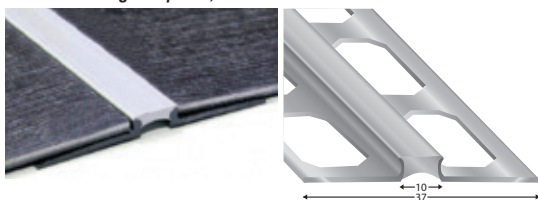

Artikel-Nr. article-no.	Fugenfarbe joint colour	VE unit
DF604 GRAU	grau/grey	10

Preis/Stange price/piece	
270 cm	270 cm
Lagerware	Bestellware
14,84	

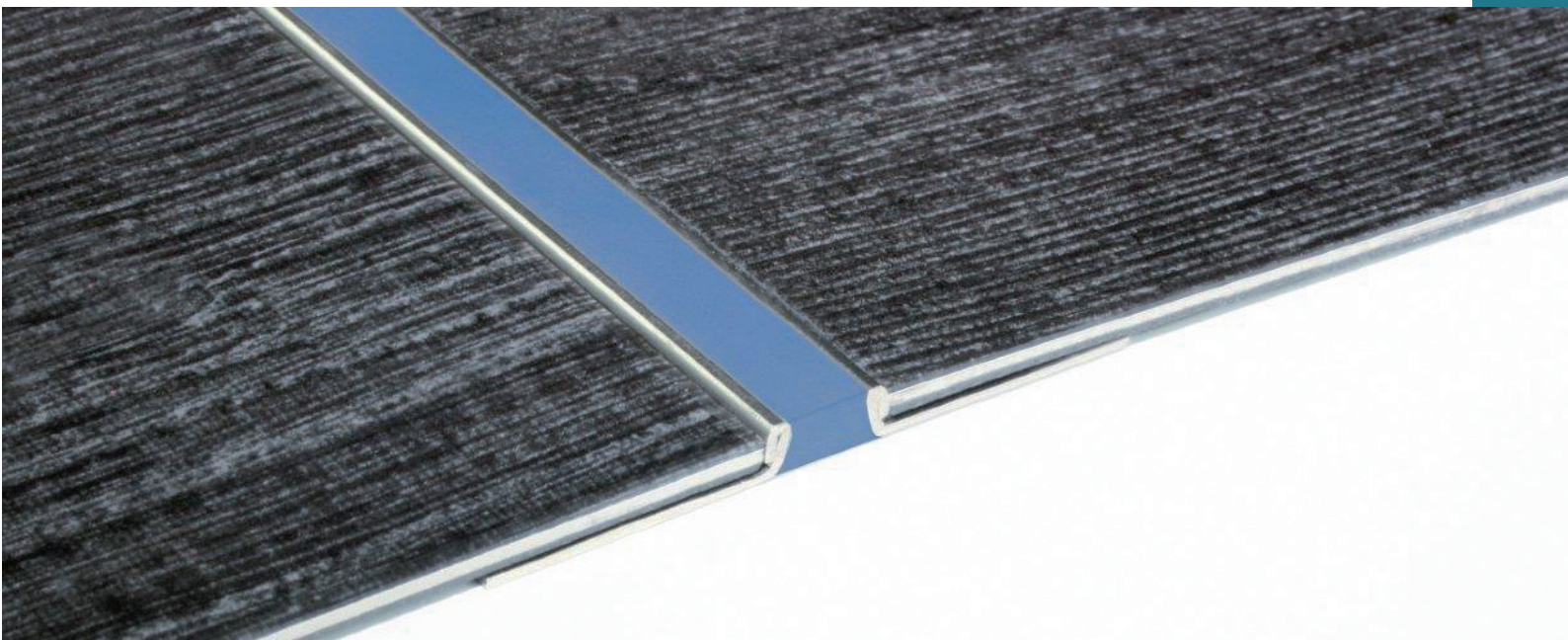

OBJEKT BEWEGUNGSFUGEN

in Aluminium RAL Farben nach Wahl

EXPANSION JOINTS

in aluminium RAL colours

DFR 2,2 RAL

BEWEGUNGSFUGE in Aluminium, roh
EXPANSION JOINT in aluminium, raw
 Höhen bis / heights up to 2,2 mm

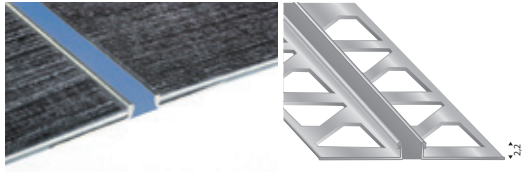

Artikel-Nr.
article-no.

Fugenfarbe
joint colour

VE
unit

DFR 2,2 RAL

RAL-Fugenfarbe nach Wahl
RAL-joint colour of your choice

Preis/Stange
price/piece

250 cm 250 cm

Lagerware	Bestellware
	*

DFR 2,5 RAL

BEWEGUNGSFUGE in Aluminium, roh
EXPANSION JOINT in aluminium, raw
 Höhen bis / heights up to 2,5 mm

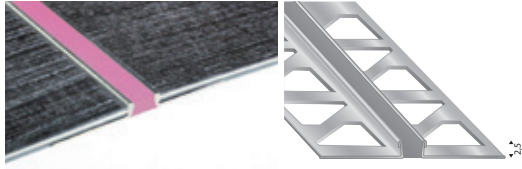

Artikel-Nr.
article-no.

Fugenfarbe
joint colour

VE
unit

DFR 2,5 RAL

RAL-Fugenfarbe nach Wahl
RAL-joint colour of your choice

Preis/Stange
price/piece

250 cm 250 cm

Lagerware	Bestellware
	*

DFR 2,8 RAL

BEWEGUNGSFUGE in Aluminium, roh
EXPANSION JOINT in aluminium, raw
 Höhen bis / heights up to 2,8 mm

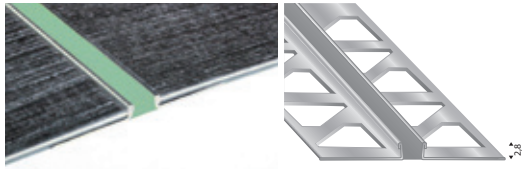

Artikel-Nr.
article-no.

Fugenfarbe
joint colour

VE
unit

DFR 2,8 RAL

RAL-Fugenfarbe nach Wahl
RAL-joint colour of your choice

Preis/Stange
price/piece

250 cm 250 cm

Lagerware	Bestellware
	*

DFR 3 RAL

BEWEGUNGSFUGE in Aluminium, roh
EXPANSION JOINT in aluminium, raw
 Höhen bis / heights up to 3 mm

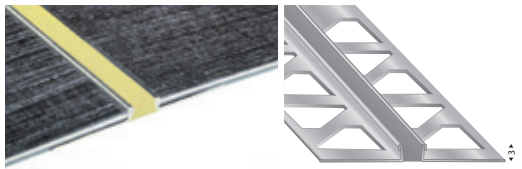

Artikel-Nr.
article-no.

Fugenfarbe
joint colour

VE
unit

DFR 3 RAL

RAL-Fugenfarbe nach Wahl
RAL-joint colour of your choice

Preis/Stange
price/piece

250 cm 250 cm

Lagerware	Bestellware
	*

DFR 4,5 RAL

BEWEGUNGSFUGE in Aluminium, roh
EXPANSION JOINT in aluminium, raw
 Höhen bis / heights up to 4,5 mm

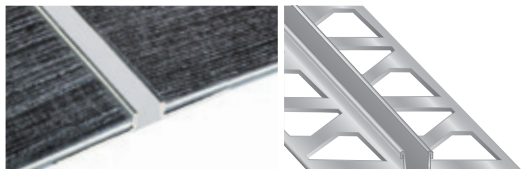

Artikel-Nr.
article-no.

Fugenfarbe
joint colour

VE
unit

DFR 4,5 RAL

RAL-Fugenfarbe nach Wahl
RAL-joint colour of your choice

Preis/Stange
price/piece

250 cm 250 cm

Lagerware	Bestellware
	*

DFR 6 RAL

BEWEGUNGSFUGE in Aluminium, roh
EXPANSION JOINT in aluminium, raw
 Höhen bis / heights up to 6 mm

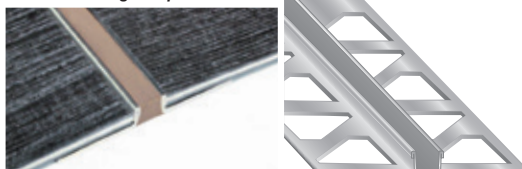

Artikel-Nr.
article-no.

Fugenfarbe
joint colour

VE
unit

DFR 6 RAL

RAL-Fugenfarbe nach Wahl
RAL-joint colour of your choice

Preis/Stange
price/piece

250 cm 250 cm

Lagerware	Bestellware
	*

Untermengenaufschlag + 400 € , Bestellware 3-4 Wochen, ab 100 Stangen
Minor quantity surcharge + 400 € , order goods 3-4 weeks, from 100 profiles

*** Preis auf Anfrage / price on request**

5B

DFR 8 RAL

BEWEGUNGSFUGE in Aluminium, roh
EXPANSION JOINT in aluminium, raw
 Höhen bis / heights up to 8 mm

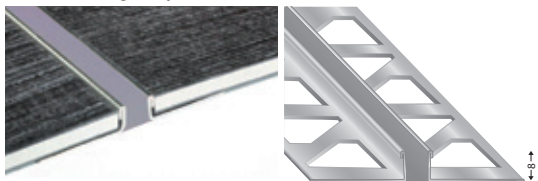

Artikel-Nr.
article-no.

Fugenfarbe
joint colour

VE
unit

DFR 8 RAL

RAL-Fugenfarbe nach Wahl
RAL-joint colour of your choice

Preis/Stange
price/piece

250 cm	250 cm
Lagerware	Bestellware
	*

DFR 10 RAL

BEWEGUNGSFUGE in Aluminium, roh
EXPANSION JOINT in aluminium, raw
 Höhen bis / heights up to 10 mm

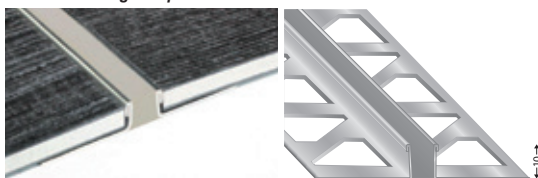

Artikel-Nr.
article-no.

Fugenfarbe
joint colour

VE
unit

DFR 10 RAL

RAL-Fugenfarbe nach Wahl
RAL-joint colour of your choice

Preis/Stange
price/piece

250 cm	250 cm
Lagerware	Bestellware
	*

DFR 12 RAL

BEWEGUNGSFUGE in Aluminium, roh
EXPANSION JOINT in aluminium, raw
 Höhen bis / heights up to 12,5 mm



Artikel-Nr.
article-no.

Fugenfarbe
joint colour

VE
unit

DFR 12 RAL

RAL-Fugenfarbe nach Wahl
RAL-joint colour of your choice

Preis/Stange
price/piece

250 cm	250 cm
Lagerware	Bestellware
	*

DFR 15 RAL

BEWEGUNGSFUGE in Aluminium, roh
EXPANSION JOINT in aluminium, raw
 Höhen bis / heights up to 15 mm



Artikel-Nr.
article-no.

Fugenfarbe
joint colour

VE
unit

DFR 15 RAL

RAL-Fugenfarbe nach Wahl
RAL-joint colour of your choice

Preis/Stange
price/piece

250 cm	250 cm
Lagerware	Bestellware
	*

DFR 18 RAL

BEWEGUNGSFUGE in Aluminium, roh
EXPANSION JOINT in aluminium, raw
 Höhen bis / heights up to 18 mm



Artikel-Nr.
article-no.

Fugenfarbe
joint colour

VE
unit

DFR 18 RAL

RAL-Fugenfarbe nach Wahl
RAL-joint colour of your choice

Preis/Stange
price/piece

250 cm	250 cm
Lagerware	Bestellware
	*

DFR 20 RAL

BEWEGUNGSFUGE in Aluminium, roh
EXPANSION JOINT in aluminium, raw
 Höhen bis / heights up to 20 mm



Artikel-Nr.
article-no.

Fugenfarbe
joint colour

VE
unit

DFR 20 RAL

RAL-Fugenfarbe nach Wahl
RAL-joint colour of your choice

Preis/Stange
price/piece

250 cm	250 cm
Lagerware	Bestellware
	*

Untermengenaufschlag + 400 € , Bestellware 3-4 Wochen, ab 100 Stangen
Minor quantity surcharge + 400 €, order goods 3-4 weeks, from 100 profiles

*** Preis auf Anfrage / price on request**



BIEGEPROFILE

in Aluminium

BENDING PROFILES

in aluminium

3119 3

BIEGEPROFIL „PRIMO“ in Aluminium
BENDING PROFILE „PRIMO“ in aluminium
 Innenhöhe / inner-height 3 mm

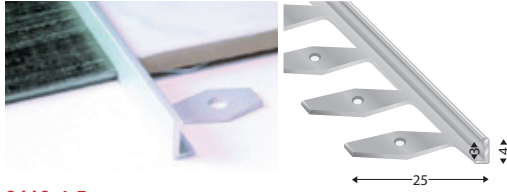

Artikel-Nr. article-no.	Farbe colour	VE unit
3119 3 S 3	silber/silver	10

Preis/Stange price/piece	
300 cm	300 cm
Lagerware	Bestellware
35,61	

3119 4,5

BIEGEPROFIL „PRIMO“ in Aluminium
BENDING PROFILE „PRIMO“ in aluminium
 Innenhöhe / inner-height 4,5 mm

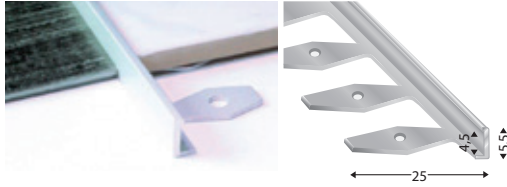

Artikel-Nr. article-no.	Farbe colour	VE unit
3119 4,5 S 3	silber/silver	10

Preis/Stange price/piece	
300 cm	300 cm
Lagerware	Bestellware
36,74	

3119 6

BIEGEPROFIL „PRIMO“ in Aluminium
BENDING PROFILE „PRIMO“ in aluminium
 Innenhöhe / inner-height 6 mm

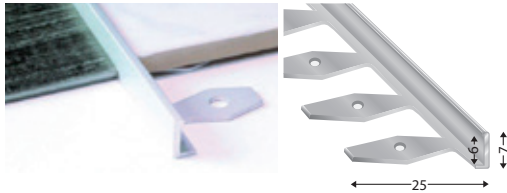

Artikel-Nr. article-no.	Farbe colour	VE unit
3119 6 S 3	silber/silver	10

Preis/Stange price/piece	
300 cm	300 cm
Lagerware	Bestellware
37,81	

3119 8

BIEGEPROFIL „PRIMO“ in Aluminium
BENDING PROFILE „PRIMO“ in aluminium
 Innenhöhe / inner-height 8 mm

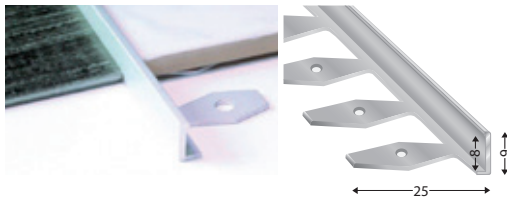

Artikel-Nr. article-no.	Farbe colour	VE unit
3119 8 S 3	silber/silver	10

Preis/Stange price/piece	
300 cm	300 cm
Lagerware	Bestellware
39,00	

3119 10

BIEGEPROFIL „PRIMO“ in Aluminium
BENDING PROFILE „PRIMO“ in aluminium
 Innenhöhe / inner-height 10 mm

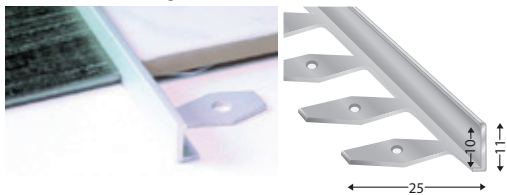

Artikel-Nr. article-no.	Farbe colour	VE unit
3119 10 S 3	silber/silver	10

Preis/Stange price/piece	
300 cm	300 cm
Lagerware	Bestellware
40,19	

3119 12

BIEGEPROFIL „PRIMO“ in Aluminium
BENDING PROFILE „PRIMO“ in aluminium
 Innenhöhe / inner-height 12,5 mm

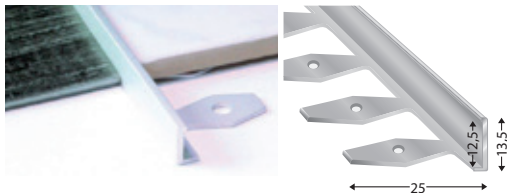

Artikel-Nr. article-no.	Farbe colour	VE unit
3119 12 S 3	silber/silver	10

Preis/Stange price/piece	
300 cm	300 cm
Lagerware	Bestellware
43,39	

3119 15

BIEGEPROFIL „PRIMO“ in Aluminium
BENDING PROFILE „PRIMO“ in aluminium
 Innenhöhe / inner-height 15 mm

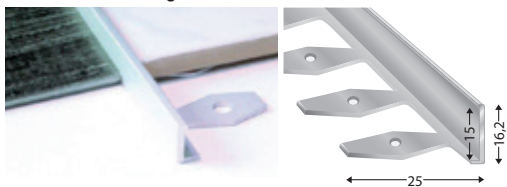

Artikel-Nr. article-no.	Farbe colour	VE unit
3119 15 S 3	silber/silver	10

Preis/Stange price/piece	
300 cm	300 cm
Lagerware	Bestellware
46,40	

5C

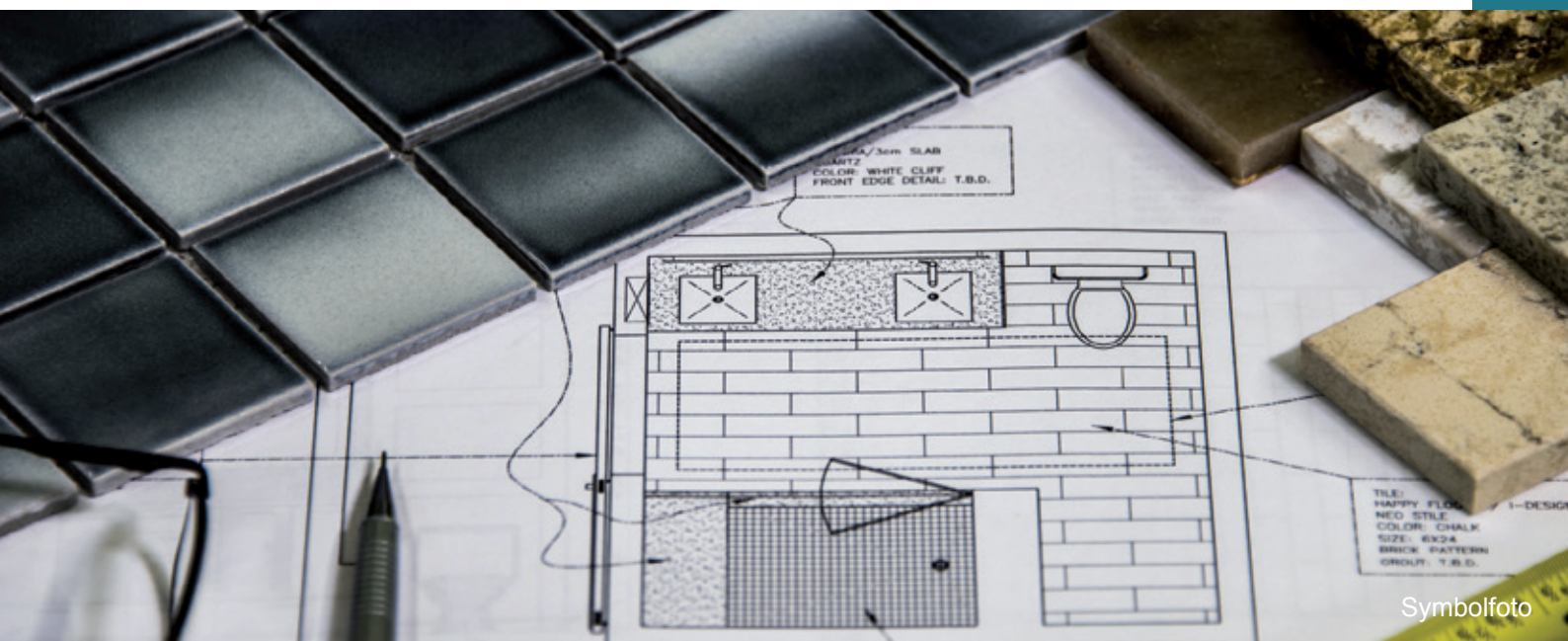

ZUBEHÖR FLIESENPROFILE

*FITTINGS for PROFILES for
CERAMIC TILES*

217 E 7

FLIP „QUADRA“ Endstück zu Serie 217 aus Aluminium
FLIP „QUADRA“ endcap to series 217 in aluminium
 8x8 mm



Artikel-Nr. article-no.	Farbe colour	VE unit
217 E 7 S	silber/silver	1

Lagerware	Bestellware
	*

217 E 9

FLIP „QUADRA“ Endstück zu Serie 217 aus Aluminium
FLIP „QUADRA“ endcap to series 217 in aluminium
 10x10 mm



Artikel-Nr. article-no.	Farbe colour	VE unit
217 E 9 S	silber/silver	1

Lagerware	Bestellware
	*

217 E 11

FLIP „QUADRA“ Endstück zu Serie 217 aus Aluminium
FLIP „QUADRA“ endcap to series 217 in aluminium
 12x12 mm



Artikel-Nr. article-no.	Farbe colour	VE unit
217 E 11 S	silber/silver	1

Lagerware	Bestellware
	*

217 E 13

FLIP „QUADRA“ Endstück zu Serie 217 aus Aluminium
FLIP „QUADRA“ endcap to series 217 in aluminium
 14x14 mm



Artikel-Nr. article-no.	Farbe colour	VE unit
217 E 13 S	silber/silver	1

Lagerware	Bestellware
	*

218 E 6

FLIP „RONDO“ Endstück zu Serie 218 aus Aluminium
FLIP „RONDO“ endcap to series 218 in aluminium
 6 mm



Artikel-Nr. article-no.	Farbe colour	VE unit
218 E 6 S	silber/silver	1

Lagerware	Bestellware
	*

218 E 8

FLIP „RONDO“ Endstück zu Serie 218 aus Aluminium
FLIP „RONDO“ endcap to series 218 in aluminium
 8 mm



Artikel-Nr. article-no.	Farbe colour	VE unit
218 E 8 S	silber/silver	1

Lagerware	Bestellware
	*

218 E 10

FLIP „RONDO“ Endstück zu Serie 218 aus Aluminium
FLIP „RONDO“ endcap to series 218 in aluminium
 10 mm



Artikel-Nr. article-no.	Farbe colour	VE unit
218 E 10 S	silber/silver	1

Lagerware	Bestellware
	*

* Preis auf Anfrage / price on request

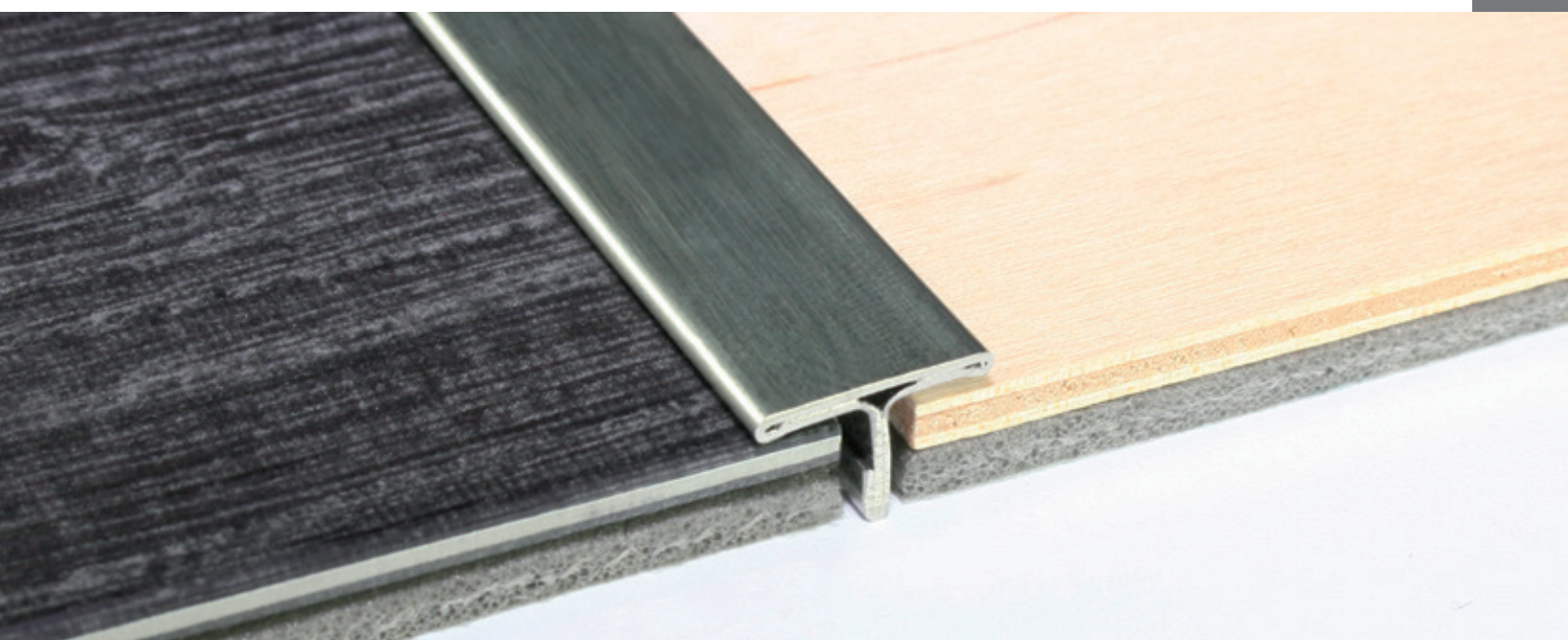

INOX MONOPROFILE

INOX MONOPROFILES

13515 E

ÜBERGANGSPROFIL T-Form, Edelstahl
JOINING PROFILE T-shape, stainless steel
15x7 mm

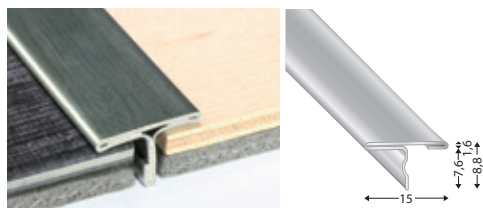

Artikel-Nr. article-no.	Farbe colour	VE unit
13515 E	Edelstahl / stainless steel	10

Preis/Stange price/piece	
250 cm	250 cm
Lagerware	Bestellware
43,64	

13525 E

ÜBERGANGSPROFIL T-Form, Edelstahl
JOINING PROFILE T-shape, stainless steel
25x7 mm

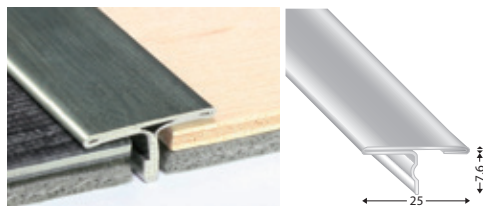

Artikel-Nr. article-no.	Farbe colour	VE unit
13525 E	Edelstahl/ stainless steel	10

Preis/Stange price/piece	
250 cm	250 cm
Lagerware	Bestellware
57,16	

903 30 E GEB

ÜBERGANGSPROFIL, gebohrt, Edelstahl
JOINING PROFILE, drilled, stainless steel
30x1 mm

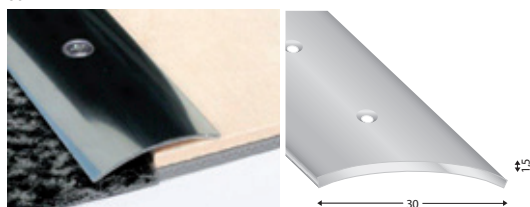

Artikel-Nr. article-no.	Farbe colour	VE unit
903 30 E GEB	Edelstahl/ stainless steel	10

Preis/Stange price/piece	
270 cm	270 cm
Lagerware	Bestellware
20,27	

903 30 E UNG

ÜBERGANGSPROFIL, ungebohrt, Edelstahl
JOINING PROFILE, undrilled, stainless steel
30x1 mm

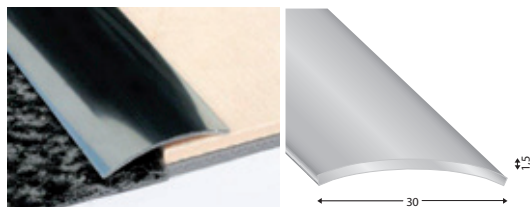

Artikel-Nr. article-no.	Farbe colour	VE unit
903 30 E UNG	Edelstahl/ stainless steel	10

Preis/Stange price/piece	
270 cm	270 cm
Lagerware	Bestellware
20,27	

903 30 E SKL

ÜBERGANGSPROFIL, selbstklebend, Edelstahl
JOINING PROFILE, self-adhesive, stainless steel
30x1 mm

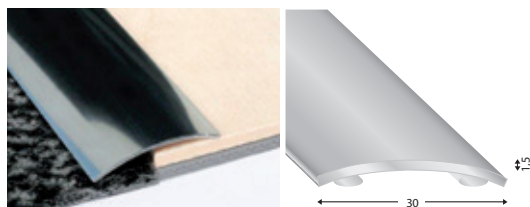

Artikel-Nr. article-no.	Farbe colour	VE unit
903 30 E SKL	Edelstahl/ stainless steel	10

Preis/Stange price/piece	
270 cm	270 cm
Lagerware	Bestellware
24,95	

9031 30 E

ÜBERGANGSPROFIL, versetzt gebohrt, Edelstahl
JOINING PROFILE, laterally drilled, stainless steel
30x1 mm

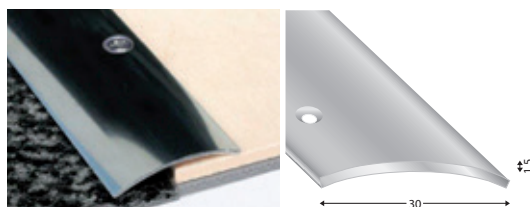

Artikel-Nr. article-no.	Farbe colour	VE unit
9031 30 E	Edelstahl/ stainless steel	10

Preis/Stange price/piece	
270 cm	270 cm
Lagerware	Bestellware
20,27	

6A

903 40 E GEB

ÜBERGANGSPROFIL, gebohrt, Edelstahl
JOINING PROFILE, drilled, stainless steel
40x1 mm



Artikel-Nr. article-no.	Farbe colour	VE unit
903 40 E GEB	Edelstahl/ stainless steel	10

Preis/Stange price/piece		Preis/Stück price/piece	
270 cm	270 cm	100 cm	100 cm
Lagerware	Bestellware	Lagerware	Bestellware
26,50			

903 40 E UNG

ÜBERGANGSPROFIL, ungebohrt, Edelstahl
JOINING PROFILE, undrilled, stainless steel
40x1 mm

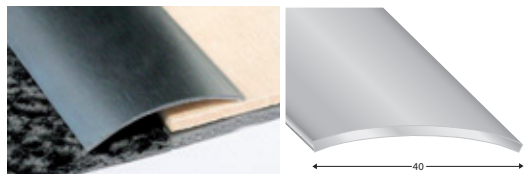

Artikel-Nr. article-no.	Farbe colour	VE unit
903 40 E UNG	Edelstahl/ stainless steel	10

Preis/Stange price/piece		Preis/Stück price/piece	
270 cm	270 cm	100 cm	100 cm
Lagerware	Bestellware	Lagerware	Bestellware
26,21			

903 40 E SKL

ÜBERGANGSPROFIL, selbstklebend, Edelstahl
JOINING PROFILE, self-adhesive, stainless steel
40x1 mm

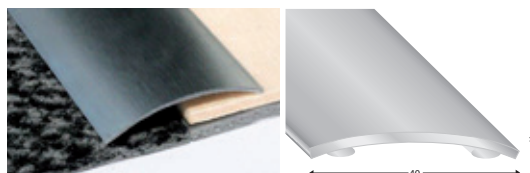

Artikel-Nr. article-no.	Farbe colour	VE unit
903 40 E SKL	Edelstahl/ stainless steel	10

Preis/Stange price/piece		Preis/Stück price/piece	
270 cm	270 cm	100 cm	100 cm
Lagerware	Bestellware	Lagerware	Bestellware
30,10			

136 CP 8

ÜBERGANGSPROFIL, selbstklebend, Edelstahl
JOINING PROFILE, self-adhesive, stainless steel
80 mm

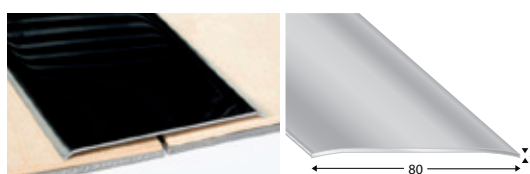

Artikel-Nr. article-no.	Farbe colour	VE unit
136 CP 8 E	Edelstahl/ stainless steel	10

Preis/Stange price/piece		Preis/Stück price/piece	
270 cm	270 cm	100 cm	100 cm
Lagerware	Bestellware	Lagerware	Bestellware
	*		

123 CO 25

MAUERKANTE, selbstklebend, Edelstahl
WALL CORNER, self-adhesive, stainless steel
25x25x1 mm

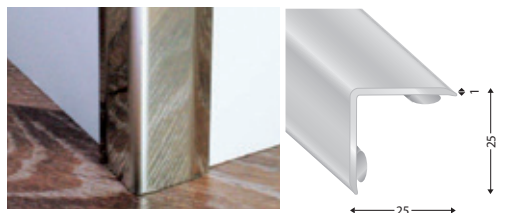

Artikel-Nr. article-no.	Farbe colour	VE unit
123 CO 25 E 123 CO 25 E2	Edelstahl/ stainless steel	10

Preis/Stange price/piece		Preis/Stück price/piece	
300 cm	300 cm	150 cm	150 cm
Lagerware	Bestellware	Lagerware	Bestellware
63,14		34,76	

123 CO 30

MAUERKANTE, selbstklebend, Edelstahl
WALL CORNER, self-adhesive, stainless steel
30x30x1 mm

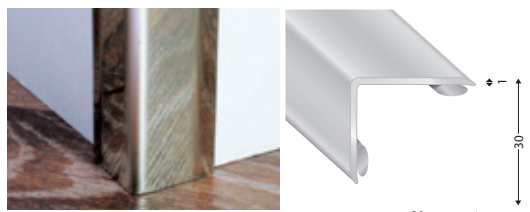

Artikel-Nr. article-no.	Farbe colour	VE unit
123 CO 30 E 123 CO 30 E2	Edelstahl/ stainless steel	10

Preis/Stange price/piece		Preis/Stück price/piece	
300 cm	300 cm	150 cm	150 cm
Lagerware	Bestellware	Lagerware	Bestellware
99,19		54,61	

123 CO 40

MAUERKANTE, selbstklebend, Edelstahl
WALL CORNER, self-adhesive, stainless steel
40x40x1,2 mm



Artikel-Nr. article-no.	Farbe colour	VE unit
123 CO 40 E 123 CO 40 E2	Edelstahl/ stainless steel	10

Preis/Stange price/piece		Preis/Stück price/piece	
300 cm	300 cm	150 cm	150 cm
Lagerware	Bestellware	Lagerware	Bestellware
121,89		67,01	

* Preis auf Anfrage / price on request

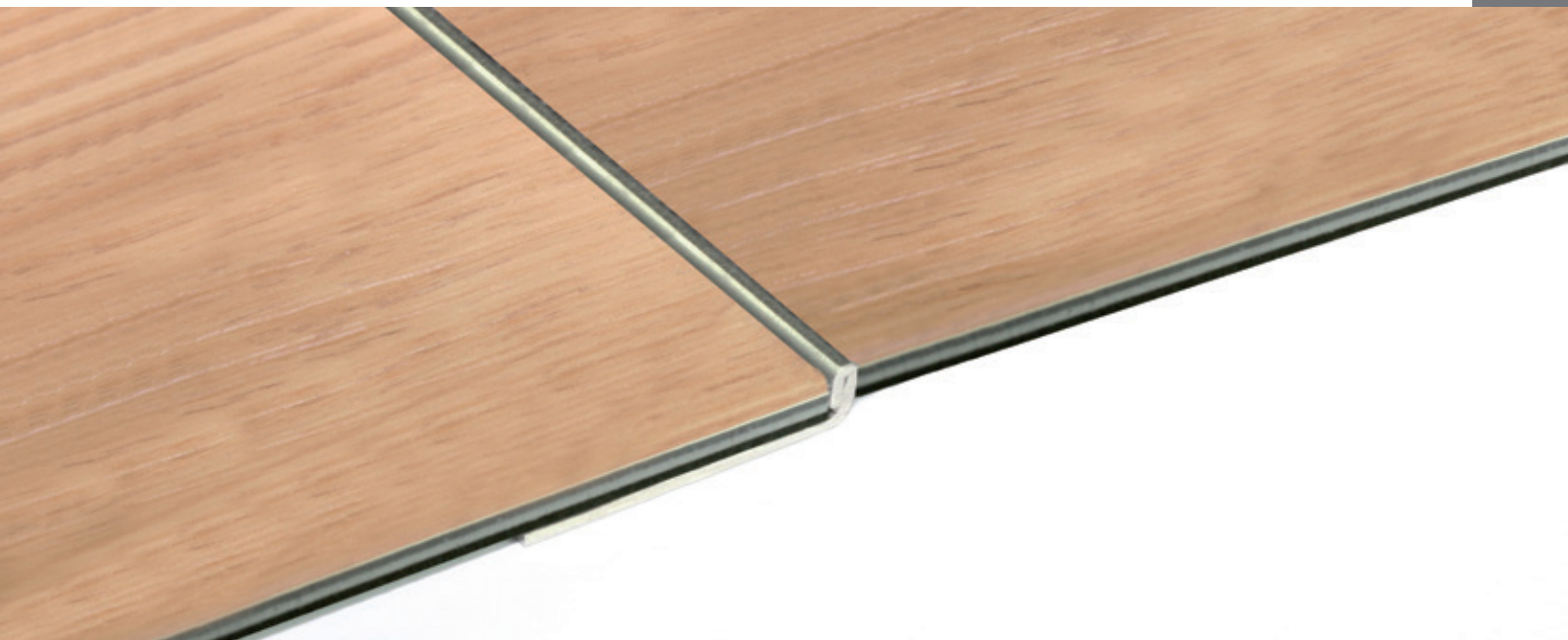

INOX FLIESENPROFILE

INOX PROFILES FOR CERAMIC TILES

119 3 E

FLIESENPROFIL „PRIMO“ in Edelstahl
 PROFILE FOR CERAMIC TILES „PRIMO“ in stainless steel
 Innenhöhe / inner-height 3 mm



Artikel-Nr. article-no.	Farbe colour	VE unit
119 3 E 2,5	Edelstahl/ stainless steel	10

Preis/Stange price/piece	
250 cm	250 cm
Lagerware	Bestellware
40,34	

119 4,5 E

FLIESENPROFIL „PRIMO“ in Edelstahl
 PROFILE FOR CERAMIC TILES „PRIMO“ in stainless steel
 Innenhöhe / inner-height 4,5 mm



Artikel-Nr. article-no.	Farbe colour	VE unit
119 4,5 E 3	Edelstahl/ stainless steel	10

Preis/Stange price/piece	
300 cm	300 cm
Lagerware	Bestellware
49,09	

119 6 E

FLIESENPROFIL „PRIMO“ in Edelstahl
 PROFILE FOR CERAMIC TILES „PRIMO“ in stainless steel
 Innenhöhe / inner-height 6 mm

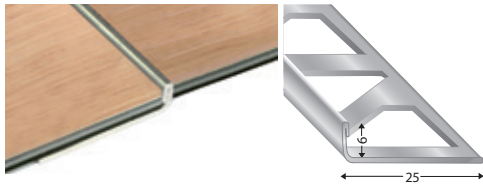

Artikel-Nr. article-no.	Farbe colour	VE unit
119 6 E 3	Edelstahl/ stainless steel	10

Preis/Stange price/piece	
300 cm	300 cm
Lagerware	Bestellware
51,73	

119 8 E

FLIESENPROFIL „PRIMO“ in Edelstahl
 PROFILE FOR CERAMIC TILES „PRIMO“ in stainless steel
 Innenhöhe / inner-height 8 mm

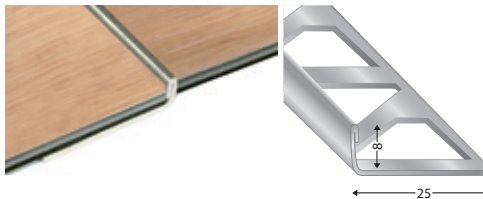

Artikel-Nr. article-no.	Farbe colour	VE unit
119 8 E 3	Edelstahl/ stainless steel	10

Preis/Stange price/piece	
300 cm	300 cm
Lagerware	Bestellware
55,18	

119 10 E

FLIESENPROFIL „PRIMO“ in Edelstahl
 PROFILE FOR CERAMIC TILES „PRIMO“ in stainless steel
 Innenhöhe / inner-height 10 mm

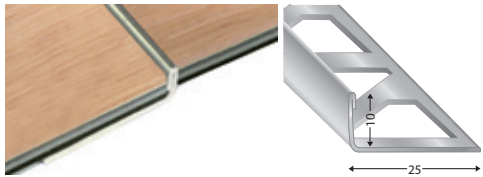

Artikel-Nr. article-no.	Farbe colour	VE unit
119 10 E 3	Edelstahl/ stainless steel	10

Preis/Stange price/piece	
300 cm	300 cm
Lagerware	Bestellware
57,31	

119 11 E

FLIESENPROFIL „PRIMO“ in Edelstahl
 PROFILE FOR CERAMIC TILES „PRIMO“ in stainless steel
 Innenhöhe / inner-height 11 mm

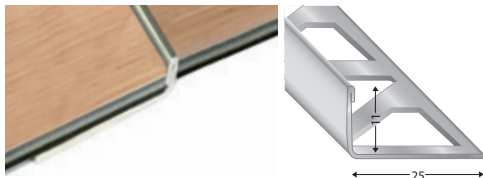

Artikel-Nr. article-no.	Farbe colour	VE unit
119 11 E 3	Edelstahl/ stainless steel	10

Preis/Stange price/piece	
300 cm	300 cm
Lagerware	Bestellware
	*

119 12 E

FLIESENPROFIL „PRIMO“ in Edelstahl
 PROFILE FOR CERAMIC TILES „PRIMO“ in stainless steel
 Innenhöhe / inner-height 12,5 mm

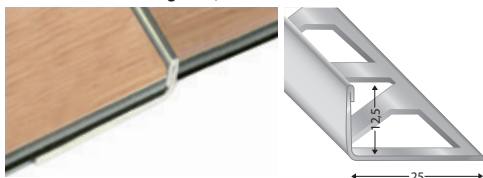

Artikel-Nr. article-no.	Farbe colour	VE unit
119 12 E 3	Edelstahl/ stainless steel	10

Preis/Stange price/piece	
300 cm	300 cm
Lagerware	Bestellware
64,83	

* Preis auf Anfrage / price on request

6B

119 15 E

FLIESENPROFIL „PRIMO“ in Edelstahl
PROFILE FOR CERAMIC TILES „PRIMO“ in stainless steel
 Innenhöhe / inner-height 15 mm

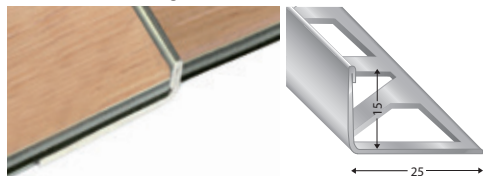

Artikel-Nr. article-no.	Farbe colour	VE unit
119 15 E 3	Edelstahl/ stainless steel	10

Preis/Stange price/piece	
300 cm	300 cm
Lagerware	Bestellware
89,41	

119 18 E

FLIESENPROFIL „PRIMO“ in Edelstahl
PROFILE FOR CERAMIC TILES „PRIMO“ in stainless steel
 Innenhöhe / inner-height 18 mm

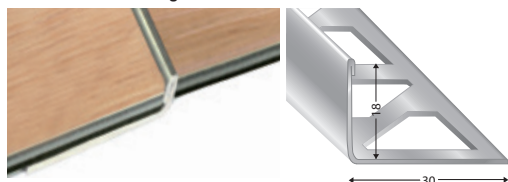

Artikel-Nr. article-no.	Farbe colour	VE unit
119 18 E 3	Edelstahl/ stainless steel	10

Preis/Stange price/piece	
300 cm	300 cm
Lagerware	Bestellware
98,75	

119 22 E

FLIESENPROFIL „PRIMO“ in Edelstahl
PROFILE FOR CERAMIC TILES „PRIMO“ in stainless steel
 Innenhöhe / inner-height 22 mm



Artikel-Nr. article-no.	Farbe colour	VE unit
119 22 E 3	Edelstahl/ stainless steel	10

Preis/Stange price/piece	
300 cm	300 cm
Lagerware	Bestellware
107,34	

121 C 8 E

FLIESENPROFIL „QUADRA“ in Edelstahl
PROFILE FOR CERAMIC TILES „QUADRA“ in stainless steel
 Innenhöhe / inner-height 8 mm



Artikel-Nr. article-no.	Farbe colour	VE unit
121 C 8 E	Edelstahl/ stainless steel	10

Preis/Stange price/piece	
250 cm	250 cm
Lagerware	Bestellware
64,37	

121 C 9 E

FLIESENPROFIL „QUADRA“ in Edelstahl
PROFILE FOR CERAMIC TILES „QUADRA“ in stainless steel
 Innenhöhe / inner-height 9 mm



Artikel-Nr. article-no.	Farbe colour	VE unit
121 C 9 E	Edelstahl/ stainless steel	10

Preis/Stange price/piece	
250 cm	250 cm
Lagerware	Bestellware
72,06	

121 C 11 E

FLIESENPROFIL „QUADRA“ in Edelstahl
PROFILE FOR CERAMIC TILES „QUADRA“ in stainless steel
 Innenhöhe / inner-height 11 mm



Artikel-Nr. article-no.	Farbe colour	VE unit
121 C 11 E	Edelstahl/ stainless steel	10

Preis/Stange price/piece	
250 cm	250 cm
Lagerware	Bestellware
75,83	

121 C 12 E

FLIESENPROFIL „QUADRA“ in Edelstahl
PROFILE FOR CERAMIC TILES „QUADRA“ in stainless steel
 Innenhöhe / inner-height 12,5 mm

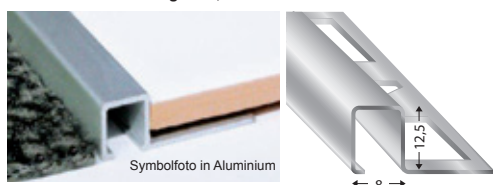

Artikel-Nr. article-no.	Farbe colour	VE unit
121 C 12 E	Edelstahl/ stainless steel	10

Preis/Stange price/piece	
250 cm	250 cm
Lagerware	Bestellware
76,70	

118 6 E

FLIESENPROFIL „RONDO“ in Edelstahl
PROFILE FOR CERAMIC TILES „RONDO“ in stainless steel
 Innenhöhe / inner-height 6 mm

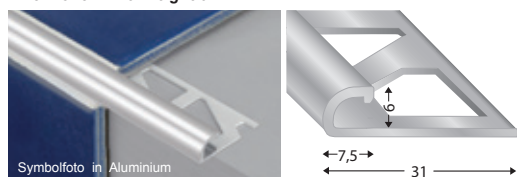

Artikel-Nr. article-no.	Farbe colour	VE unit
118 6 E 3	Edelstahl/ stainless steel	10

Preis/Stange price/piece	
300 cm	300 cm
Lagerware	Bestellware
55,99	

118 8 E

FLIESENPROFIL „RONDO“ in Edelstahl
PROFILE FOR CERAMIC TILES „RONDO“ in stainless steel
 Innenhöhe / inner-height 8 mm

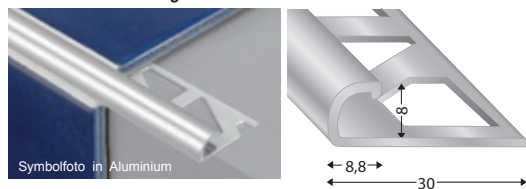

Artikel-Nr. article-no.	Farbe colour	VE unit
118 8 E 3	Edelstahl/ stainless steel	10

Preis/Stange price/piece	
300 cm	300 cm
Lagerware	Bestellware
58,00	

118 10 E

FLIESENPROFIL „RONDO“ in Edelstahl
PROFILE FOR CERAMIC TILES „RONDO“ in stainless steel
 Innenhöhe / inner-height 10 mm

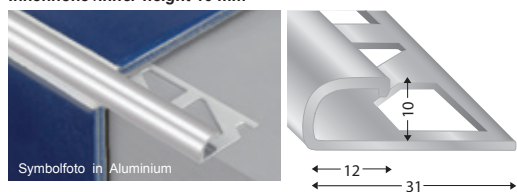

Artikel-Nr. article-no.	Farbe colour	VE unit
118 10 E 3	Edelstahl/ stainless steel	10

Preis/Stange price/piece	
300 cm	300 cm
Lagerware	Bestellware
61,38	

118 12 E

FLIESENPROFIL „RONDO“ in Edelstahl
PROFILE FOR CERAMIC TILES „RONDO“ in stainless steel
 Innenhöhe / inner-height 12,5 mm

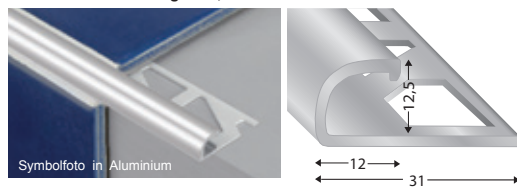

Artikel-Nr. article-no.	Farbe colour	VE unit
118 12 E 3	Edelstahl/ stainless steel	10

Preis/Stange price/piece	
300 cm	300 cm
Lagerware	Bestellware
66,96	

6B

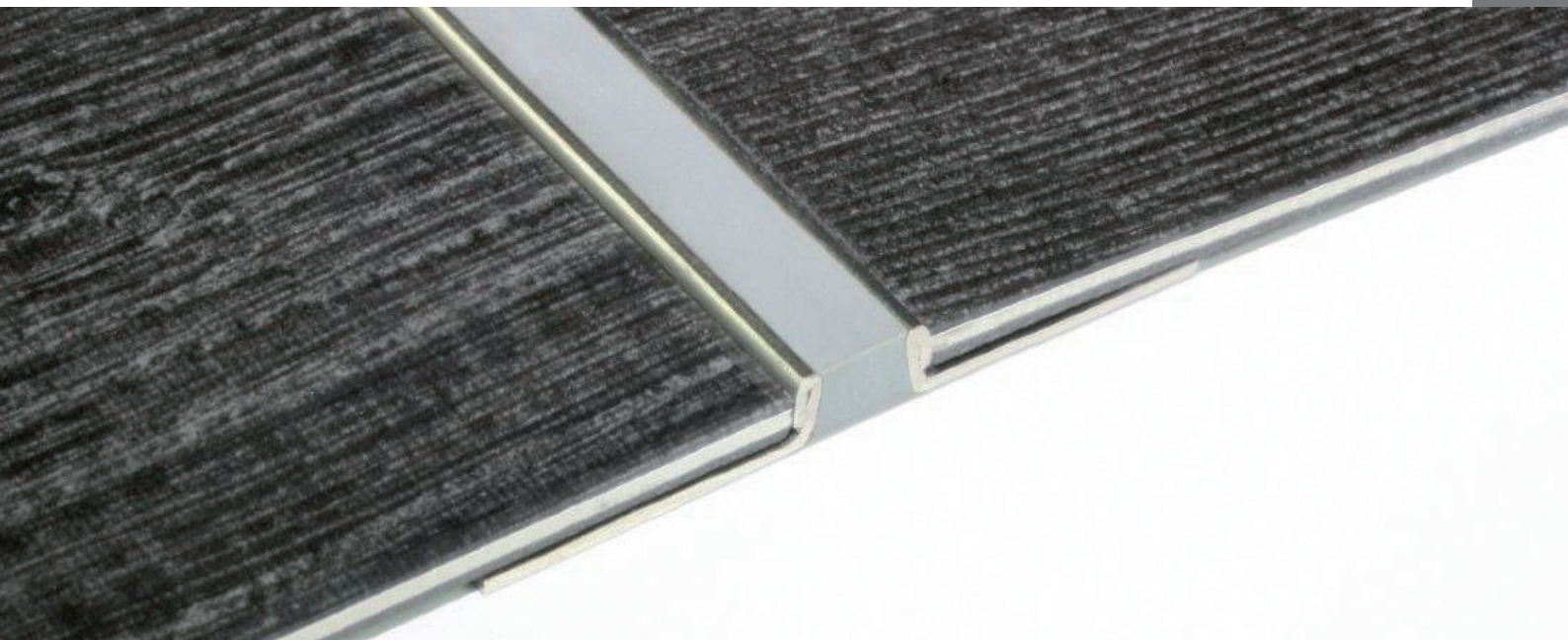

INOX BEWEGUNGSFUGEN

INOX EXPANSION JOINTS

DF 119 3 E

BEWEGUNGSFUGE in Edelstahl
 EXPANSION JOINT in stainless steel
 Höhen bis / heights up to 3 mm

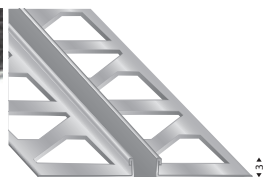
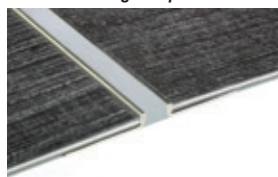

Artikel-Nr. article-no.	Fugenfarbe joint colour	VE unit
DF119 3 E	grau/grey	10

Preis/Stange price/piece	
250 cm	250 cm
Lagerware	Bestellware
164,17	

DF 119 4,5 E

BEWEGUNGSFUGE in Edelstahl
 EXPANSION JOINT in stainless steel
 Höhen bis / heights up to 4,5 mm

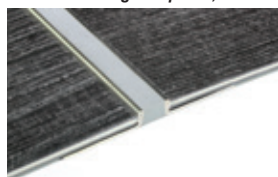

Artikel-Nr. article-no.	Fugenfarbe joint colour	VE unit
DF119 4,5 E	grau/grey	10

Preis/Stange price/piece	
250 cm	250 cm
Lagerware	Bestellware
165,11	

DF 119 6 E

BEWEGUNGSFUGE in Edelstahl
 EXPANSION JOINT in stainless steel
 Höhen bis / heights up to 6 mm

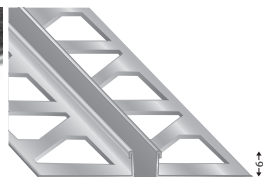
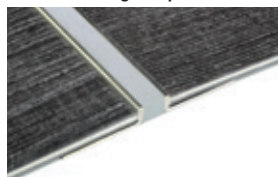

Artikel-Nr. article-no.	Fugenfarbe joint colour	VE unit
DF119 6 E	grau/grey	10

Preis/Stange price/piece	
250 cm	250 cm
Lagerware	Bestellware
166,07	

DF 119 8 E

BEWEGUNGSFUGE in Edelstahl
 EXPANSION JOINT in stainless steel
 Höhen bis / heights up to 8 mm

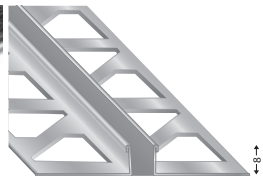
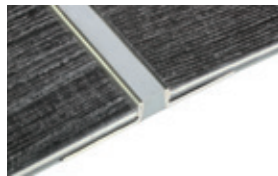

Artikel-Nr. article-no.	Fugenfarbe joint colour	VE unit
DF119 8 E	grau/grey	10

Preis/Stange price/piece	
250 cm	250 cm
Lagerware	Bestellware
170,19	

DF 119 10 E

BEWEGUNGSFUGE in Edelstahl
 EXPANSION JOINT in stainless steel
 Höhen bis / heights up to 10 mm

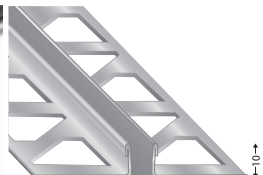
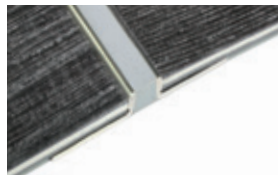

Artikel-Nr. article-no.	Fugenfarbe joint colour	VE unit
DF119 10 E	grau/grey	10

Preis/Stange price/piece	
250 cm	250 cm
Lagerware	Bestellware
178,42	

DF 119 12 E

BEWEGUNGSFUGE in Edelstahl
EXPANSION JOINT in stainless steel
 Höhen bis / heights up to 12,5 mm

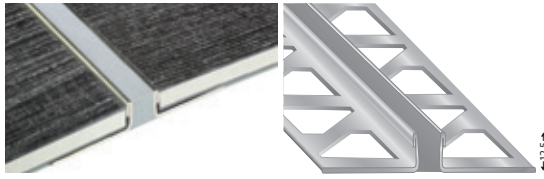

Artikel-Nr. article-no.	Fugenfarbe joint colour	VE unit
DF119 12 E	grau/grey	10

Preis/Stange price/piece	
250 cm	250 cm
Lagerware	Bestellware
188,29	

6C

DF 119 15 E

BEWEGUNGSFUGE in Edelstahl
EXPANSION JOINT in stainless steel
 Höhen bis / heights up to 15 mm

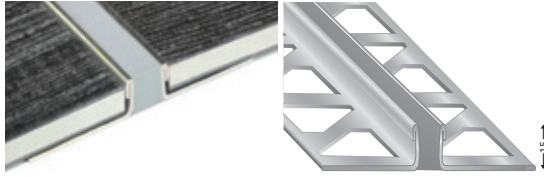

Artikel-Nr. article-no.	Fugenfarbe joint colour	VE unit
DF119 15 E	grau/grey	10

Preis/Stange price/piece	
250 cm	250 cm
Lagerware	Bestellware
	*

DF 119 18 E

BEWEGUNGSFUGE in Edelstahl
EXPANSION JOINT in stainless steel
 Höhen bis / heights up to 18 mm

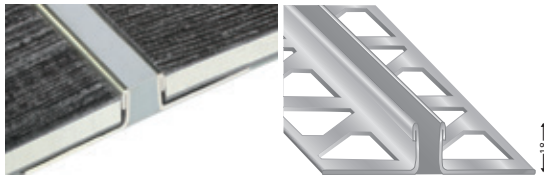

Artikel-Nr. article-no.	Fugenfarbe joint colour	VE unit
DF119 18 E	grau/grey	10

Preis/Stange price/piece	
250 cm	250 cm
Lagerware	Bestellware
	*

DF 119 20 E

BEWEGUNGSFUGE in Edelstahl
EXPANSION JOINT in stainless steel
 Höhen bis / heights up to 20 mm



Artikel-Nr. article-no.	Fugenfarbe joint colour	VE unit
DF119 20 E	grau/grey	10

Preis/Stange price/piece	
250 cm	250 cm
Lagerware	Bestellware
	*

* Preis auf Anfrage / price on request

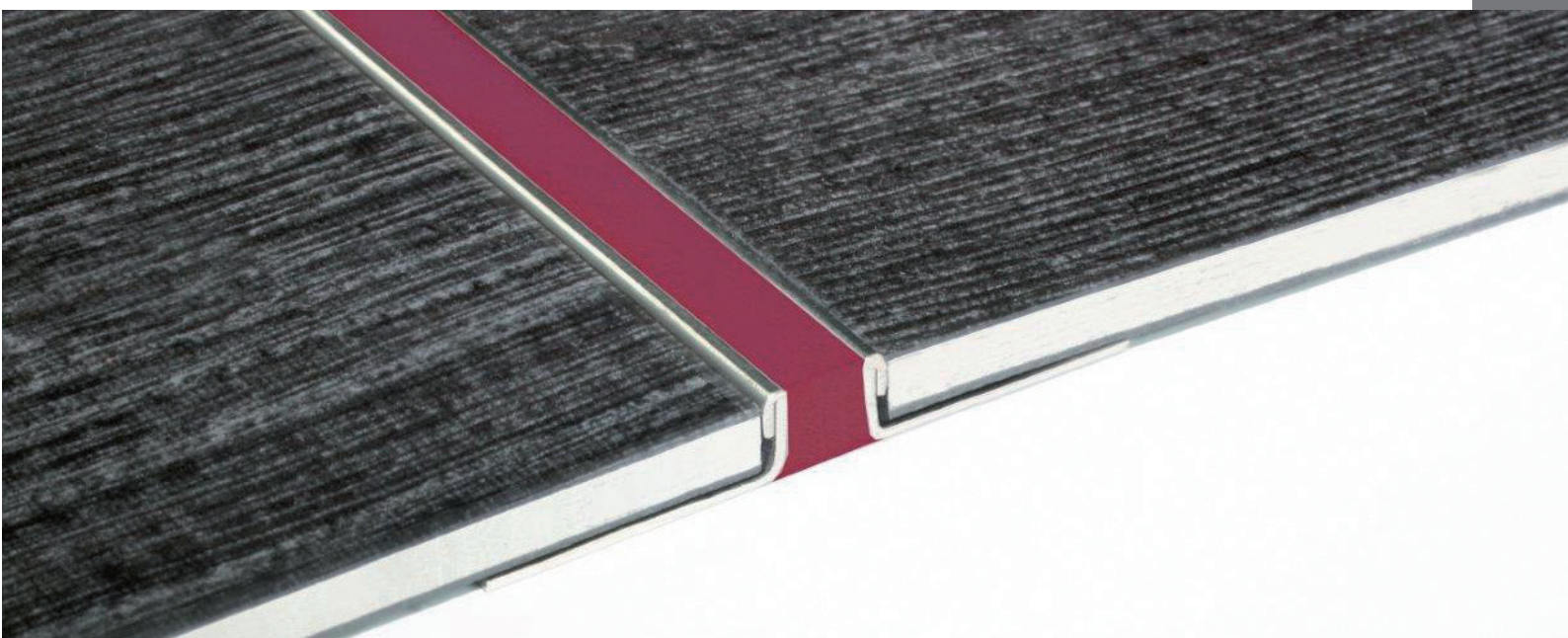

OBJEKT INOX BEWEGUNGSFUGEN

RAL Farben nach Wahl

***CONTRACTING -
INOX EXPANSION JOINTS***

RAL colours of your choice

DFE 2 RAL

BEWEGUNGSFUGE in Edelstahl
EXPANSION JOINT in stainless steel
 Höhen bis / heights up to 2 mm

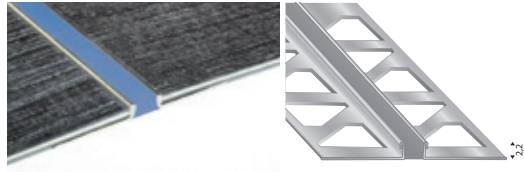

Artikel-Nr.
article-no.

Fugenfarbe
joint colour

VE
unit

Preis/Stange
price/piece

250 cm 250 cm

Lagerware	Bestellware
	*

DFE 2 RAL

RAL-Fugenfarbe nach Wahl
RAL-joint colour of your choice

DFE 3 RAL

BEWEGUNGSFUGE in Edelstahl
EXPANSION JOINT in stainless steel
 Höhen bis / heights up to 3 mm

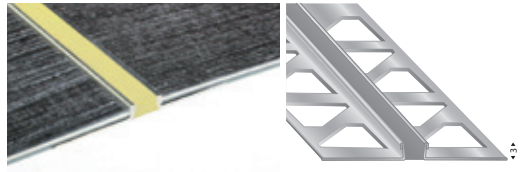

Artikel-Nr.
article-no.

Fugenfarbe
joint colour

VE
unit

Preis/Stange
price/piece

250 cm 250 cm

Lagerware	Bestellware
	*

DFE 3 RAL

RAL-Fugenfarbe nach Wahl
RAL-joint colour of your choice

DFE 4,5 RAL

BEWEGUNGSFUGE in Edelstahl
EXPANSION JOINT in stainless steel
 Höhen bis / heights up to 4,5 mm

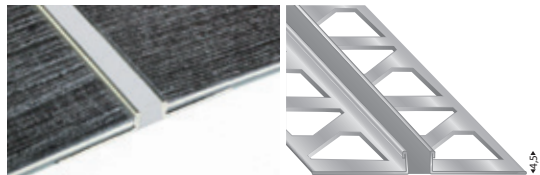

Artikel-Nr.
article-no.

Fugenfarbe
joint colour

VE
unit

Preis/Stange
price/piece

250 cm 250 cm

Lagerware	Bestellware
	*

DFE 4,5 RAL

RAL-Fugenfarbe nach Wahl
RAL-joint colour of your choice

DFE 6 RAL

BEWEGUNGSFUGE in Edelstahl
EXPANSION JOINT in stainless steel
 Höhen bis / heights up to 6 mm

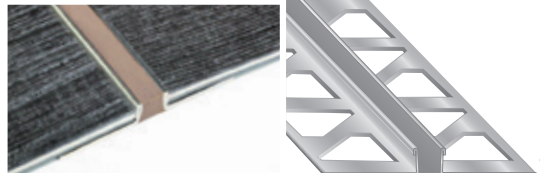

Artikel-Nr.
article-no.

Fugenfarbe
joint colour

VE
unit

Preis/Stange
price/piece

250 cm 250 cm

Lagerware	Bestellware
	*

DFE 6 RAL

RAL-Fugenfarbe nach Wahl
RAL-joint colour of your choice

DFE 8 RAL

BEWEGUNGSFUGE in Edelstahl
EXPANSION JOINT in stainless steel
 Höhen bis / heights up to 8 mm

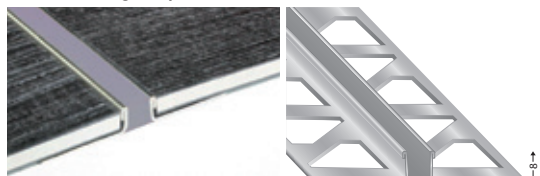

Artikel-Nr.
article-no.

Fugenfarbe
joint colour

VE
unit

Preis/Stange
price/piece

250 cm 250 cm

Lagerware	Bestellware
	*

DFE 8 RAL

RAL-Fugenfarbe nach Wahl
RAL-joint colour of your choice

Untermengenaufschlag + 400 € , Bestellware 3-4 Wochen, ab 100 Stangen
Minor quantity surcharge + 400 € , order goods 3-4 weeks, from 100 profiles

*** Preis auf Anfrage / price on request**

DFE 10 RAL

BEWEGUNGSFUGE in Edelstahl
EXPANSION JOINT in stainless steel
 Höhen bis / heights up to 10 mm

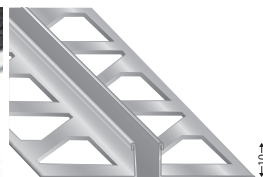
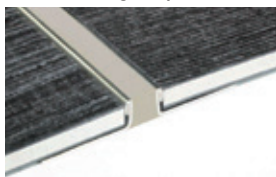

DFE 10 RAL

Artikel-Nr.
article-no.

Fugenfarbe
joint colour

VE
unit

RAL-Fugenfarbe nach Wahl
RAL-joint colour of your choice

Preis/Stange
price/piece

250 cm	
Lagerware	Bestellware
	*

6C

DFE 12 RAL

BEWEGUNGSFUGE in Edelstahl
EXPANSION JOINT in stainless steel
 Höhen bis / heights up to 12,5 mm

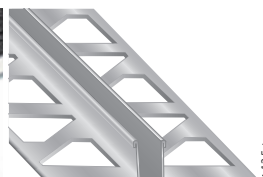

DFE 12 RAL

Artikel-Nr.
article-no.

Fugenfarbe
joint colour

VE
unit

RAL-Fugenfarbe nach Wahl
RAL-joint colour of your choice

Preis/Stange
price/piece

250 cm	
Lagerware	Bestellware
	*

DFE 15 RAL

BEWEGUNGSFUGE in Edelstahl
EXPANSION JOINT in stainless steel
 Höhen bis / heights up to 15 mm

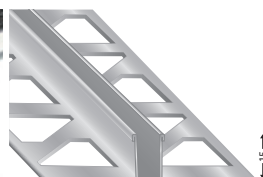
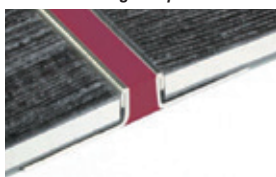

DFE 15 RAL

Artikel-Nr.
article-no.

Fugenfarbe
joint colour

VE
unit

RAL-Fugenfarbe nach Wahl
RAL-joint colour of your choice

Preis/Stange
price/piece

250 cm	
Lagerware	Bestellware
	*

DFE 18 RAL

BEWEGUNGSFUGE in Edelstahl
EXPANSION JOINT in stainless steel
 Höhen bis / heights up to 18 mm

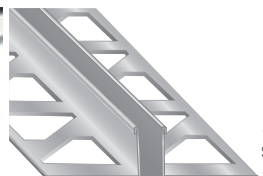

DFE 18 RAL

Artikel-Nr.
article-no.

Fugenfarbe
joint colour

VE
unit

RAL-Fugenfarbe nach Wahl
RAL-joint colour of your choice

Preis/Stange
price/piece

250 cm	
Lagerware	Bestellware
	*

DFE 20 RAL

BEWEGUNGSFUGE in Edelstahl
EXPANSION JOINT in stainless steel
 Höhen bis / heights up to 20 mm



DFE 20 RAL

Artikel-Nr.
article-no.

Fugenfarbe
joint colour

VE
unit

RAL-Fugenfarbe nach Wahl
RAL-joint colour of your choice

Preis/Stange
price/piece

250 cm	
Lagerware	Bestellware
	*

Untermengenaufschlag + 400 € , Bestellware 3-4 Wochen, ab 100 Stangen
Minor quantity surcharge + 400 €, order goods 3-4 weeks, from 100 profiles

*** Preis auf Anfrage / price on request**



Symbolfoto

INOX ZUBEHÖR

INOX FITTINGS

1121 C 8 E

FLIP „QUADRA“ Endstück zu Serie 121 C aus Edelstahl
 FLIP „QUADRA“ endcap to series 121 C for outcorners in stainless steel
 9x9 mm



Artikel-Nr. article-no.	Farbe colour	VE unit
1121 C 8 E	Edelstahl/ stainless steel	1

Lagerware	Bestellware
	*

1121 C 9 E

FLIP „QUADRA“ Endstück zu Serie 121 C aus Edelstahl
 FLIP „QUADRA“ endcap to series 121 C for outcorners in stainless steel
 10x10 mm

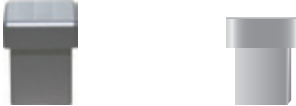

Artikel-Nr. article-no.	Farbe colour	VE unit
1121 C 9 E	Edelstahl/ stainless steel	10

Lagerware	Bestellware
	*

1121 C 10 E

FLIP „QUADRA“ Endstück zu Serie 121 C aus Edelstahl
 FLIP „QUADRA“ endcap to series 121 C for outcorners in stainless steel
 11x11 mm



Artikel-Nr. article-no.	Farbe colour	VE unit
1121 C 10 E	Edelstahl/ stainless steel	10

Lagerware	Bestellware
	*

1121 C 11 E

FLIP „QUADRA“ Endstück zu Serie 121 C aus Edelstahl
 FLIP „QUADRA“ endcap to series 121 C for outcorners in stainless steel
 12x12 mm



Artikel-Nr. article-no.	Farbe colour	VE unit
1121 C 11 E	Edelstahl/ stainless steel	10

Lagerware	Bestellware
	*

1121 C 12 E

FLIP „QUADRA“ Endstück zu Serie 121 C aus Edelstahl
 FLIP „QUADRA“ endcap to series 121 C for outcorners in stainless steel
 13x13 mm



Artikel-Nr. article-no.	Farbe colour	VE unit
1121 C 12 E	Edelstahl/ stainless steel	10

Lagerware	Bestellware
	*

1118 AE E

„RONDO“ AUSSENECKE in Edelstahl
 „RONDO“ OUTSIDE CORNER in stainless steel

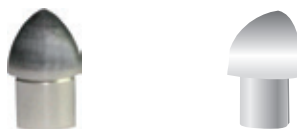

Artikel-Nr. article-no.	Farbe colour	VE unit
1118 6 AE E	Edelstahl/ stainless steel	10
1118 8 AE E	Edelstahl/ stainless steel	10
1118 10 AE E	Edelstahl/ stainless steel	10
1118 12 AE E	Edelstahl/ stainless steel	10

Lagerware	Bestellware
	*
	*
	*
	*

1118 IE E

„RONDO“ INNENECKE in Edelstahl
 „RONDO“ INSIDE CORNER in stainless steel



Artikel-Nr. article-no.	Farbe colour	VE unit
1118 6 IE E	Edelstahl/ stainless steel	10
1118 8 IE E	Edelstahl/ stainless steel	10
1118 10 IE E	Edelstahl/ stainless steel	10
1118 12 IE E	Edelstahl/ stainless steel	10

Lagerware	Bestellware
	*
	*
	*
	*

* Preis auf Anfrage / price on request



Symbolfoto

HOLZDEKOR-PROFILE

WOODEN DECOR PROFILES

201 10
AUSGLEICHSPROFIL, aus Aluminium, selbstklebend
LEVEL ADAPTING PROFILE, in aluminium, self-adhesive
 Höhen bis / heights to 10 mm

Artikel-Nr.
 article-no. Farbe
 colour

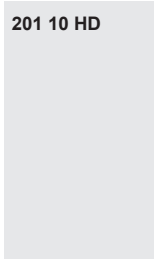
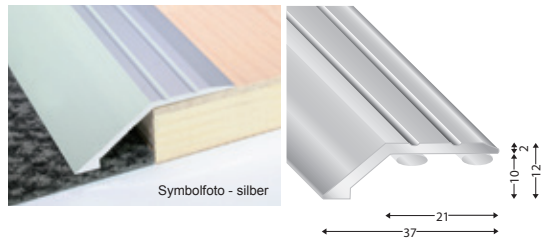

Bestellware, Mindestabnahme ab 270 lfm
 Lieferzeit auf Anfrage
 Order article, minimum order quantity 270 m
 delivery time on request

105 A
WINKELPROFIL, aus Aluminium, selbstklebend
ANGLE PROFILE, in aluminium, self-adhesive
 25 x 18 mm

Artikel-Nr.
 article-no. Farbe
 colour

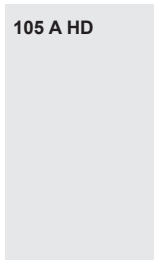
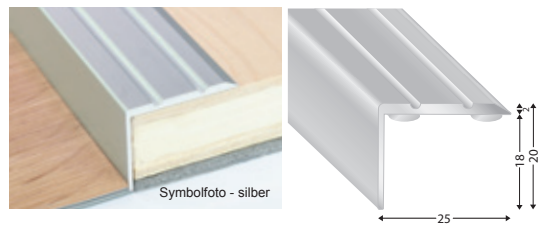

Bestellware, Mindestabnahme ab 270 lfm
 Lieferzeit auf Anfrage
 Order article, minimum order quantity 270 m
 delivery time on request

503 40
ÜBERGANGSPROFIL, aus Aluminium, selbstklebend
JOINING PROFILE, in aluminium, self-adhesive
 40 mm

Artikel-Nr.
 article-no. Farbe
 colour

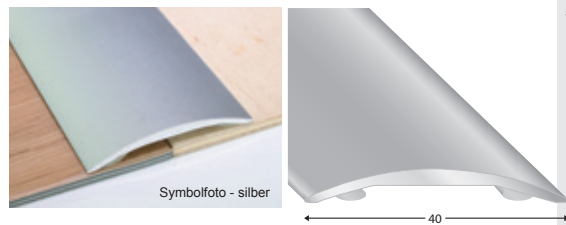

Bestellware, Mindestabnahme ab 270 lfm
 Lieferzeit auf Anfrage
 Order article, minimum order quantity 270 m
 delivery time on request

FARBKARTE
 Colour card





SOCKELLEISTEN

in Aluminium

SKIRTINGS

in aluminium

SOCKELLEISTEN

31640
SOCKELLEISTE aus Aluminium
SKIRTING in aluminium
40x11 mm

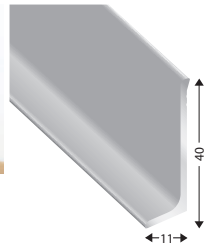

Artikel-Nr. article-no.	Farbe colour	VE unit
31640 S	silber/silver	10
31640 S 4		10
31640 EO	titan/titan	10
31640 EO 4		10
31640 WEISS	weiß/white	10
31640 WE 4		10

Preis/Stange price/piece		Preis/Stange price/piece	
270 cm	270 cm	400 cm	400 cm
Lagerware	Bestellware	Lagerware	Bestellware
19,75		29,26	
22,40		33,19	
39,50		58,52	

31660
SOCKELLEISTE aus Aluminium
SKIRTING in aluminium
60x11 mm

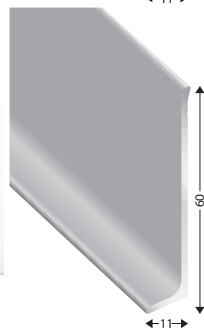

Artikel-Nr. article-no.	Farbe colour	VE unit
31660 S	silber/silver	10
31660 S 4		10
31660 EO	titan/titan	10
31660 EO 4		10
31660 WEISS	weiß/white	10
31660 WE 4		10

Preis/Stange price/piece		Preis/Stange price/piece	
270 cm	270 cm	400 cm	400 cm
Lagerware	Bestellware	Lagerware	Bestellware
23,14		34,28	
26,02		38,54	
46,00		68,13	

31680
SOCKELLEISTE aus Aluminium
SKIRTING in aluminium
80x11 mm

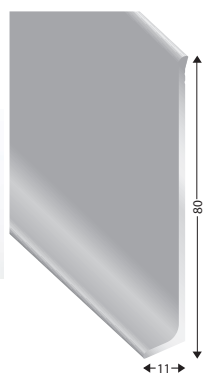

Artikel-Nr. article-no.	Farbe colour	VE unit
31680 S	silber/silver	10
31680 S 4		10
31680 EO	titan/titan	10
31680 EO 4		10
31680 WEISS	weiß/white	10
31680 WE 4		10

Preis/Stange price/piece		Preis/Stange price/piece	
270 cm	270 cm	400 cm	400 cm
Lagerware	Bestellware	Lagerware	Bestellware
30,14		44,64	
36,68		54,34	
54,17		80,26	

31610
SOCKELLEISTE aus Aluminium
SKIRTING in aluminium
100x11 mm

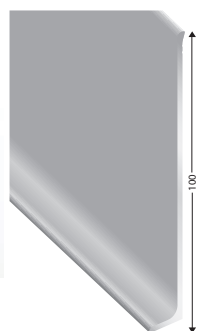

Artikel-Nr. article-no.	Farbe colour	VE unit
31610 S	silber/silver	10
31610 S 4		10

Preis/Stange price/piece		Preis/Stange price/piece	
270 cm	270 cm	400 cm	400 cm
Lagerware	Bestellware	Lagerware	Bestellware
39,10		57,93	

33650
SOCKELLEISTE aus Aluminium
SKIRTING in aluminium
50x15 mm

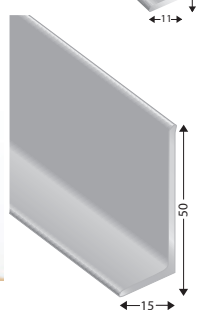

Artikel-Nr. article-no.	Farbe colour	VE unit
33650 S	silber/silver	10
33650 S 4		10

Preis/Stange price/piece		Preis/Stange price/piece	
270 cm	270 cm	400 cm	400 cm
Lagerware	Bestellware	Lagerware	Bestellware
20,61		30,51	

33670
SOCKELLEISTE aus Aluminium
SKIRTING in aluminium
70x18 mm

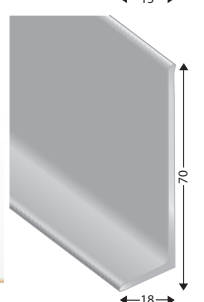

Artikel-Nr. article-no.	Farbe colour	VE unit
33670 S	silber/silver	10
33670 S 4		10

Preis/Stange price/piece		Preis/Stange price/piece	
270 cm	270 cm	400 cm	400 cm
Lagerware	Bestellware	Lagerware	Bestellware
28,78		42,64	

50132
ALUMINIUMWINKEL
Aluminium angle
50x13x2 mm



Artikel-Nr. article-no.	Farbe colour	VE unit
50132 S 4	silber/silver	10

Preis/Stange price/piece	
400 cm	400 cm
Lagerware	Bestellware
40,34	

202F
FLACHSTANGE
ALU FLAT PROFILE
20x2 mm



Artikel-Nr. article-no.	Farbe colour	VE unit
202F S 3	silber/silver	10

Preis/Stange price/piece	
300 cm	300 cm
Lagerware	Bestellware
20,82	

302F
FLACHSTANGE
ALU FLAT PROFILE
30x2 mm

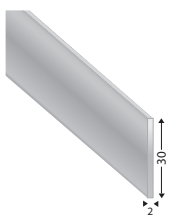

Artikel-Nr. article-no.	Farbe colour	VE unit
302F S 3	silber/silver	10

Preis/Stange price/piece	
300 cm	300 cm
Lagerware	Bestellware
30,37	

402F
FLACHSTANGE
ALU FLAT PROFILE
40x2 mm

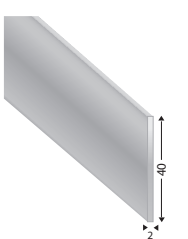

Artikel-Nr. article-no.	Farbe colour	VE unit
402F S 3	silber/silver	10

Preis/Stange price/piece	
300 cm	300 cm
Lagerware	Bestellware
39,92	

602 S
ALUMINIUMBAND
ALU FLAT PROFILE
60x2 mm

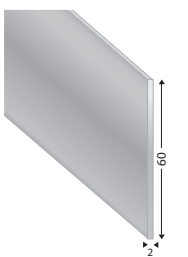

Artikel-Nr. article-no.	Farbe colour	VE unit
602 S 4	silber/silver	10

Preis/Stange price/piece	
400 cm	400 cm
Lagerware	Bestellware
40,25	

802 S
ALUMINIUMBAND
ALU FLAT PROFILE
80x2 mm

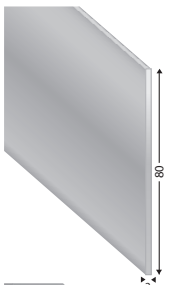

Artikel-Nr. article-no.	Farbe colour	VE unit
802 S 4	silber/silver	10

Preis/Stange price/piece	
400 cm	400 cm
Lagerware	Bestellware
53,67	

31270
TIM SOCKELLEISTE aus Aluminium
TIM SKIRTING in aluminium
70x13 mm

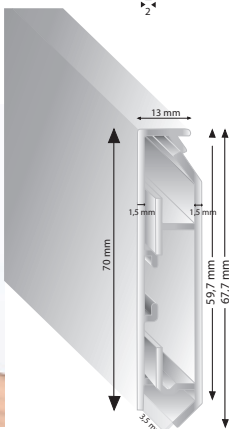

Artikel-Nr. article-no.	Farbe colour	VE unit
31270 S	silber/silver	10

Preis/Stange price/piece	
270 cm	270 cm
Lagerware	Bestellware
42,78	

8A

31960

SHAPE SOCKELLEISTE aus Aluminium bis 3 mm Beläge
 SHAPE SKIRTING in aluminium for heights up to 3 mm
 60x10,5 mm

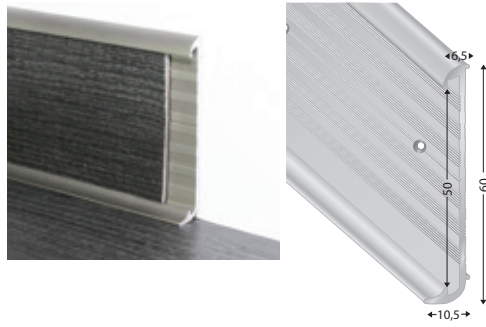

Artikel-Nr. article-no.	Farbe colour	VE unit
31960 S	silber/silver	10
31960 EO	titan/titan	10

Preis/Stange price/piece	
270 cm	270 cm
Lagerware	Bestellware
24,83	
27,02	

31965

SHAPE SOCKELLEISTE aus Aluminium bis 5,5 mm Beläge
 SHAPE SKIRTING in aluminium for heights up to 5,5 mm
 60x12,5 mm

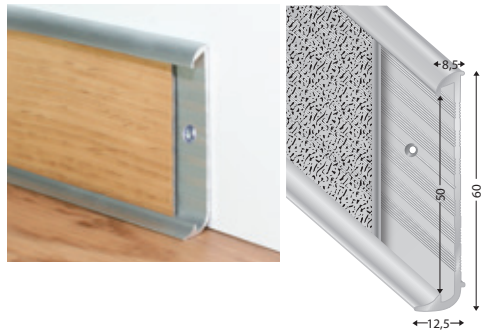

Artikel-Nr. article-no.	Farbe colour	VE unit
31965 S	silber/silver	10
31965 EO	titan/titan	10

Preis/Stange price/piece	
270 cm	270 cm
Lagerware	Bestellware
26,81	
29,24	

31005

SOCKELLEISTE für Designböden aus Aluminium
 SKIRTING for design floors in aluminium
 102,5x5,5 mm

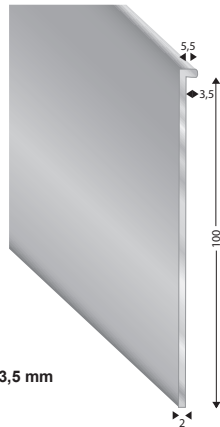

Innenhöhe / inner-height 100 mm x 3,5 mm

Artikel-Nr. article-no.	Farbe colour	VE unit
31005 S	silber/silver	10

Preis/Stange price/piece	
270 cm	270 cm
Lagerware	Bestellware
	*

31155

HOCHZUGSOCKELLEISTE für Designböden aus Aluminium
 COVE FORMING SKIRTING for design floors in aluminium
 102,5x15 mm

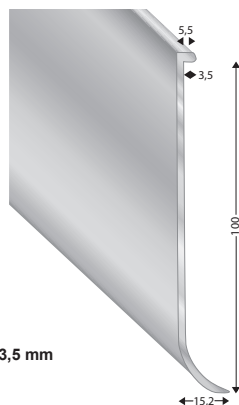

Innenhöhe / inner-height 100 mm x 3,5 mm

Artikel-Nr. article-no.	Farbe colour	VE unit
31155 S	silber/silver	10

Preis/Stange price/piece	
270 cm	270 cm
Lagerware	Bestellware
	*

* Preis auf Anfrage / price on request



SOCKELLEISTEN ZUBEHÖR

in Aluminium

FITTINGS for SKIRTINGS

in aluminium

SOCKELLEISTEN - ZUBEHÖR Serie 31600 in Aluminium
 SKIRTINGS - FITTINGS for series 31600 in aluminium

8B

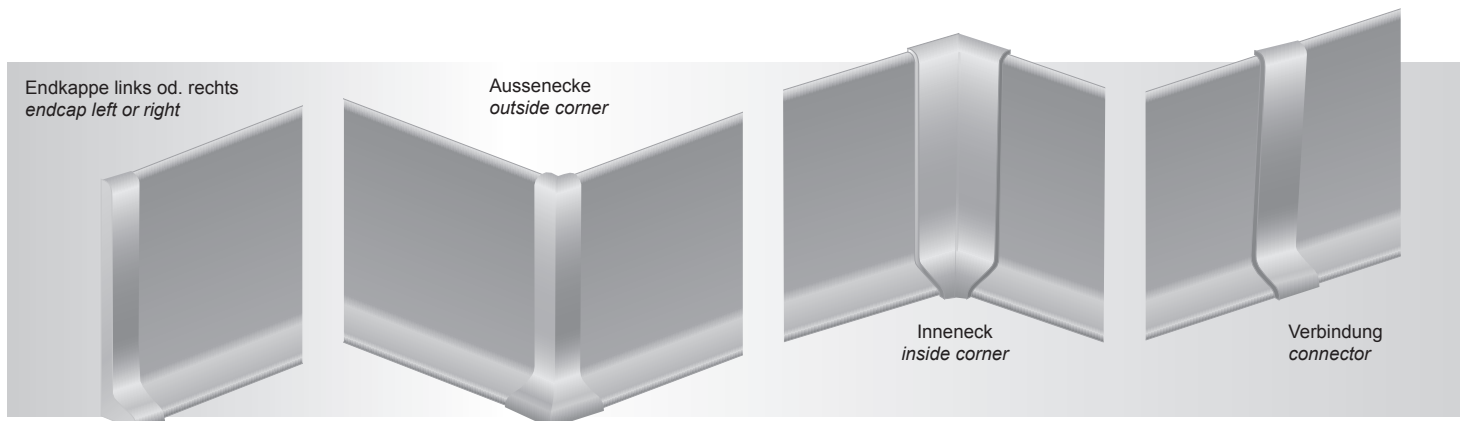

für Artikel 31640 bis 31610 / for article 31640 to 31610

		Artikel-Nr. article-no.	Farbe colour	Beschreibung description		VE unit	Preis/Stück price/piece <small>Lagerware</small>
	H= Höhe / height: 40 mm	314 E LI S	silber / silver	Endkappe links / endcap left	S	10	8,30
	H= Höhe / height: 60 mm	316 E LI S	silber / silver		S	10	9,55
	H= Höhe / height: 80 mm	318 E LI S	silber / silver		S	10	11,89
	H=Höhe / height: 100 mm	310 E LI S	silber / silver		S	10	15,22
							<small>Lagerware</small>
	H= Höhe / height: 40 mm	314 E RE S	silber / silver	Endkappe rechts / endcap right	S	10	8,30
	H= Höhe / height: 60 mm	316 E RE S	silber / silver		S	10	9,55
	H= Höhe / height: 80 mm	318 E RE S	silber / silver		S	10	11,89
	H=Höhe / height: 100 mm	310 E RE S	silber / silver		S	10	15,22
							<small>Lagerware</small>
	H= Höhe / height: 40 mm	314 VB S	silber / silver	Verbindungsstück / connecting unit	S	10	10,20
	H= Höhe / height: 60 mm	316 VB S	silber / silver		S	10	11,47
	H= Höhe / height: 80 mm	318 VB S	silber / silver		S	10	13,77
	H=Höhe / height: 100 mm	310 VB S	silber / silver		S	10	16,36
							<small>Lagerware</small>
	H= Höhe / height: 40 mm	314 IE S	silber / silver	Inneneck / inside corner	S	10	11,39
	H= Höhe / height: 60 mm	316 IE S	silber / silver		S	10	12,04
	H= Höhe / height: 80 mm	318 IE S	silber / silver		S	10	16,20
	H=Höhe / height: 100 mm	310 IE S	silber / silver		S	10	17,79
							<small>Lagerware</small>
	H= Höhe / height: 40 mm	314 AE S	silber / silver	Ausseneck / outside corner	S	10	11,39
	H= Höhe / height: 60 mm	316 AE S	silber / silver		S	10	12,04
	H= Höhe / height: 80 mm	318 AE S	silber / silver		S	10	16,20
	H=Höhe / height: 100 mm	310 AE S	silber / silver		S	10	17,79

SOCKELLEISTEN - ZUBEHÖR Serie 33600 in Aluminium
 SKIRTINGS - FITTINGS for series 33600 in aluminium

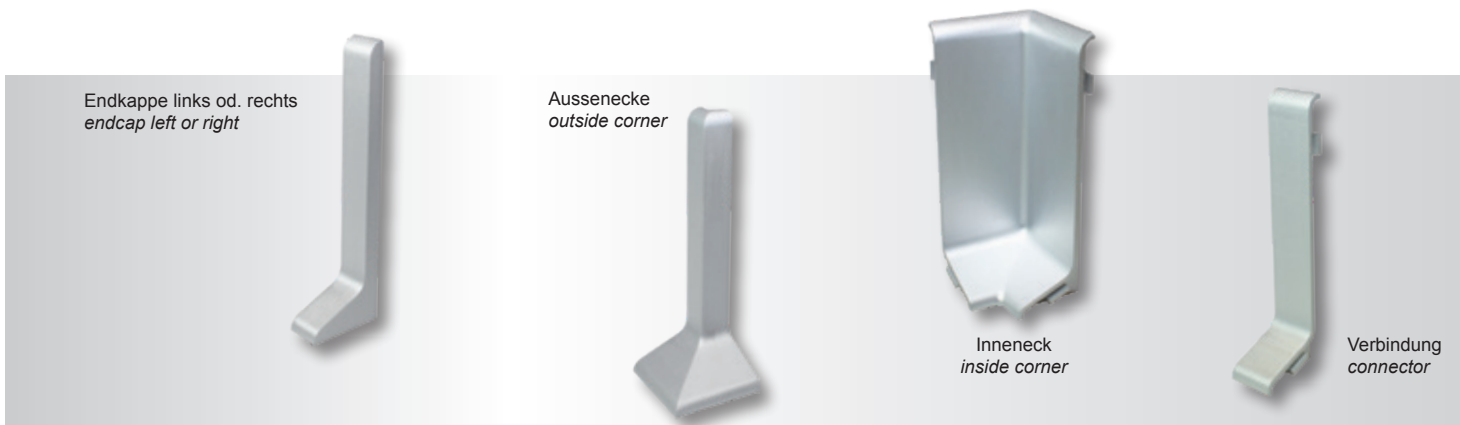

für Artikel 33650 und 33670 / for article 33650 and 33670

	Artikel-Nr. article-no.	Farbe colour	Beschreibung description	VE unit	Preis/Stück price/piece	
	H= Höhe / height: 50 mm 50 x 15 mm	335 E LI S	Endkappe links / endcap left	S	10	10,60
	H= Höhe / height: 70 mm 70 x 18 mm	337 E LI S				
	H= Höhe / height: 50 mm 50 x 15 mm	335 E RE S	Endkappe rechts / endcap right	S	10	10,60
	H= Höhe / height: 70 mm 70 x 18 mm	337 E RE S				
	H= Höhe / height: 50 mm 50 x 15 mm	335 VB S	Verbindungsstück / connecting unit	S	10	11,83
	H= Höhe / height: 70 mm 70 x 18 mm	337 VB S				
	H= Höhe / height: 50 mm 50 x 15 mm	335 IE S	Inneneck / inside corner	S	10	21,86
	H= Höhe / height: 70 mm 70 x 18 mm	337 IE S				
	H= Höhe / height: 50 mm 50 x 15 mm	335 AE S	Ausseneck / outside corner	S	10	16,32
	H= Höhe / height: 70 mm 70 x 18 mm	337 AE				

ZUBEHÖR NEU!

Für SHAPE SOCKELLEISTE aus Aluminium bis 3 mm
FITTINGS (NEW!) for SHAPE skirting in aluminium up to 3 mm

8B

3960 E LI

ENDKAPPE LINKS für 31960
 ENDCAP LEFT for 31960



Artikel-Nr. article-no.	Farbe colour	VE unit
3960 E LI S	silber/silver	10

Preis/Stück price/piece	
Lagerware	Bestellware
	*

3960 E RE

ENDKAPPE RECHTS für 31960
 ENDCAP RIGHT for 31960



Artikel-Nr. article-no.	Farbe colour	VE unit
3960 E RE S	silber/silver	10

Preis/Stück price/piece	
Lagerware	Bestellware
	*

3960 VB

VERBINDUNGSTÜCK für 31960
 CONNECTING UNIT for 31960



Artikel-Nr. article-no.	Farbe colour	VE unit
3960 VB S	silber/silver	10

Preis/Stück price/piece	
Lagerware	Bestellware
	*

3960 IE

INNENECKE für 31960
 INSIDE CORNER for 31960



Artikel-Nr. article-no.	Farbe colour	VE unit
3960 E IE S	silber/silver	10

Preis/Stück price/piece	
Lagerware	Bestellware
	*

3960 AE

AUSSENECKE für 31960
 OUTSIDE CORNER for 31960



Artikel-Nr. article-no.	Farbe colour	VE unit
3960 AE S	silber/silver	10

Preis/Stück price/piece	
Lagerware	Bestellware
	*

* Preis auf Anfrage / price on request

SOCKELLEISTEN - ZUBEHÖR Serie TIM in Aluminium
 SKIRTINGS - FITTINGS for skirting series TIM in aluminium

8B

TIM 70 IE

TIM INNENECKE - in Kunststoff für 31270
 TIM INSIDE CORNER - in synthetic for 31270
 70x13 mm



Artikel-Nr. article-no.	Farbe colour	VE unit
TIM 70 IE S	silber/silver	S 10

Preis/Stück price/piece	
Lagerware	Bestellware
2,84	

TIM 70 AE

TIM AUSSENECKE - in Kunststoff für 31270
 TIM OUTSIDE CORNER - in synthetic for 31270
 70x13 mm



Artikel-Nr. article-no.	Farbe colour	VE unit
TIM 70 AE S	silber/silver	S 10

Preis/Stück price/piece	
Lagerware	Bestellware
2,84	

TIM 70 E

TIM ENDKAPPE - in Kunststoff für 31270
 TIM END CAP- in synthetic for 31270
 70x13 mm

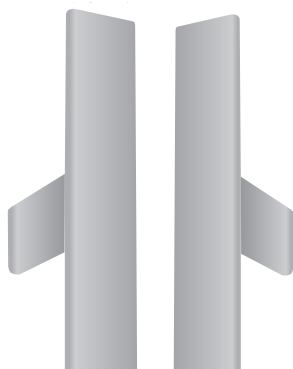

Artikel-Nr. article-no.	Farbe colour	VE unit
TIM 70 E S	silber/silver	S 10

Blister=1 x links + 1 x rechts
 Blister=1 x left + 1 x right

Preis/Blister price/piece	
Lagerware	Bestellware
3,95	



MDF SOCKELLEISTEN „regard“

MDF SKIRTINGS „regard“

8C



- In fünf Höhen von 69 - 194 mm
- Stärke jeweils 18 mm
- Stangenlänge 274 cm
- Feuchtigkeitsbeständig
- FSC Zertifiziert

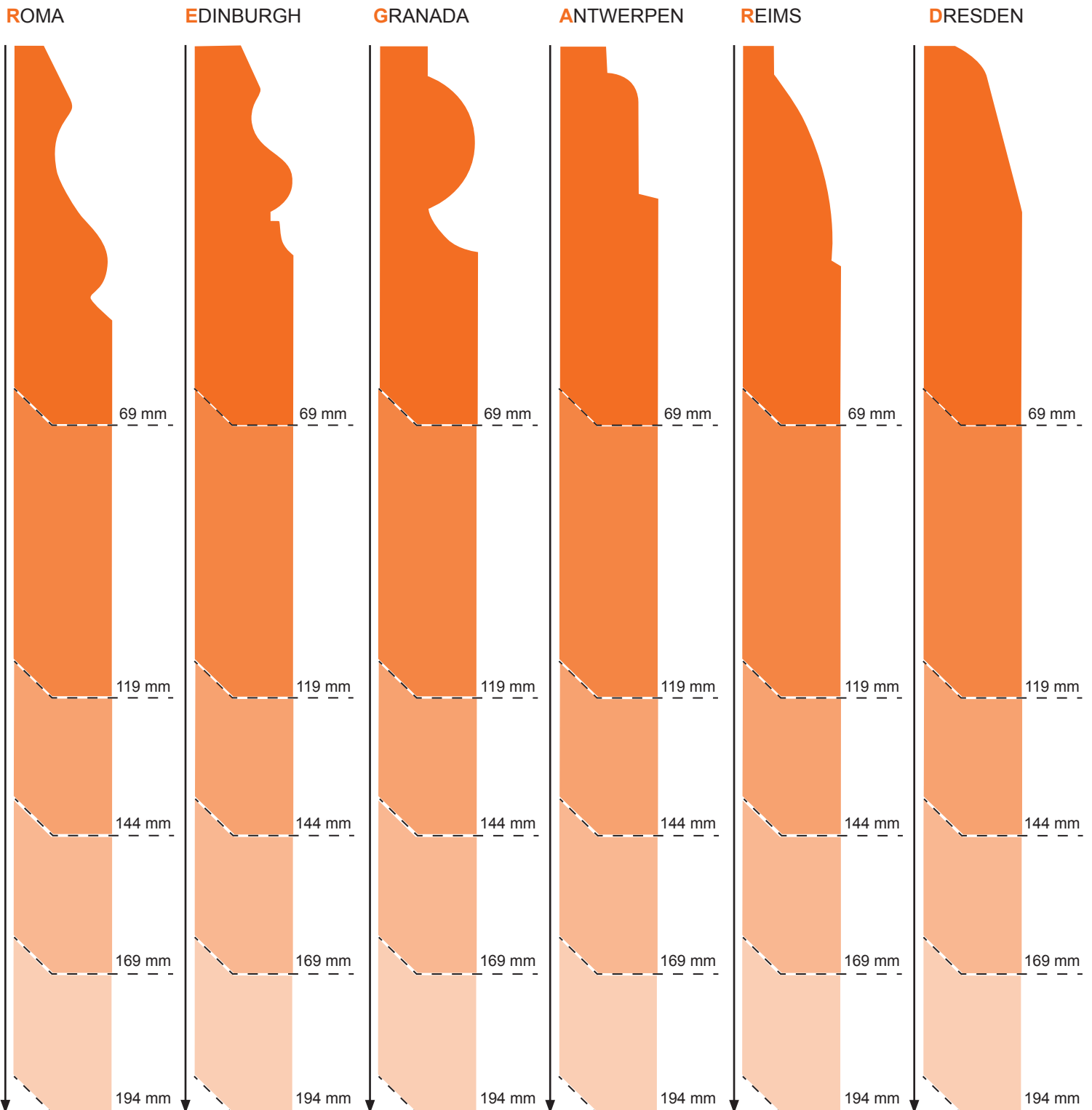

regard ROMA
MDF SOCKELLEISTE
MDF SKIRTING
69x18 mm



69x18 mm

Artikel-Nr. article-no.	Farbe colour	VE unit
R 69 GRU	grundiert/primed (G)	10
R 69 LW	weiß lackiert/ white lacquered (RAL 9016)	10

Preis/Stange price/piece	
274 cm	274 cm
Lagerware	Bestellware
35,45	*

8C

regard ROMA
MDF SOCKELLEISTE
MDF SKIRTING
119x18 mm



119x18 mm

Artikel-Nr. article-no.	Farbe colour	VE unit
R 119 GRU	grundiert/primed (G)	10
R 119 LW	weiß lackiert/ white lacquered (RAL 9016)	10

Preis/Stange price/piece	
274 cm	274 cm
Lagerware	Bestellware
62,47	*

regard ROMA
MDF SOCKELLEISTE
MDF SKIRTING
144x18 mm



144x18 mm

Artikel-Nr. article-no.	Farbe colour	VE unit
R 144 GRU	grundiert/primed (G)	10
R 144 LW	weiß lackiert/ white lacquered (RAL 9016)	10

Preis/Stange price/piece	
274 cm	274 cm
Lagerware	Bestellware
69,97	*

regard ROMA
MDF SOCKELLEISTE
MDF SKIRTING
169x18 mm



169x18 mm

Artikel-Nr. article-no.	Farbe colour	VE unit
R 169 GRU	grundiert/primed (G)	10
R 169 LW	weiß lackiert/ white lacquered (RAL 9016)	10

Preis/Stange price/piece	
274 cm	274 cm
Lagerware	Bestellware
92,84	*

regard ROMA
MDF SOCKELLEISTE
MDF SKIRTING
194x18 mm



194x18 mm

Artikel-Nr. article-no.	Farbe colour	VE unit
R 194 GRU	grundiert/primed (G)	10
R 194 LW	weiß lackiert/ white lacquered (RAL 9016)	10

Preis/Stange price/piece	
274 cm	274 cm
Lagerware	Bestellware
99,42	*

* Preis auf Anfrage / price on request

regard EDINBURGH

MDF SOCKELLEISTE

MDF SKIRTING

69x18 mm



69x18 mm

Artikel-Nr. *article-no.* Farbe *colour* VE *unit*

E 69 GRU grundiert/primed (G) 10

E 69 LW weiß lackiert/
white lacquered (RAL)

(RAL 9016)

Preis/Stange *price/piece*

274 cm	274 cm
Lagerware	Bestellware
35,45	*

regard EDINBURGH

MDF SOCKELLEISTE

MDF SKIRTING

119x18 mm



119x18 mm

Artikel-Nr. *article-no.* Farbe *colour* VE *unit*

E 119 GRU grundiert/primed (G) 10

E 119 LW weiß lackiert/
white lacquered (RAL)

(RAL 9016)

Preis/Stange *price/piece*

274 cm	274 cm
Lagerware	Bestellware
62,47	*

regard EDINBURGH

MDF SOCKELLEISTE

MDF SKIRTING

144x18 mm



144x18 mm

Artikel-Nr. *article-no.* Farbe *colour* VE *unit*

E 144 GRU grundiert/primed (G) 10

E 144 LW weiß lackiert/
white lacquered (RAL)

(RAL 9016)

Preis/Stange *price/piece*

274 cm	274 cm
Lagerware	Bestellware
69,97	*

regard EDINBURGH

MDF SOCKELLEISTE

MDF SKIRTING

169x18 mm



169x18 mm

Artikel-Nr. *article-no.* Farbe *colour* VE *unit*

E 169 GRU grundiert/primed (G) 10

E 169 LW weiß lackiert/
white lacquered (RAL)

(RAL 9016)

Preis/Stange *price/piece*

274 cm	274 cm
Lagerware	Bestellware
92,84	*

regard EDINBURGH

MDF SOCKELLEISTE

MDF SKIRTING

194x18 mm



194x18 mm

Artikel-Nr. *article-no.* Farbe *colour* VE *unit*

E 194 GRU grundiert/primed (G) 10

E 194 LW weiß lackiert/
white lacquered (RAL)

(RAL 9016)

Preis/Stange *price/piece*

274 cm	274 cm
Lagerware	Bestellware
99,42	*

* Preis auf Anfrage / price on request

regard GRANADA

MDF SOCKELLEISTE

MDF SKIRTING

69x18 mm



69x18 mm

Artikel-Nr.
article-no.

Farbe
colour

VE
unit

G 69 GRU

grundiert/primed (G)

10

G 69 LW

weiß lackiert/
white lacquered (RAL)

10

(RAL 9016)

Preis/Stange
price/piece

274 cm 274 cm

Lagerware	Bestellware
35,45	*

8C

regard GRANADA

MDF SOCKELLEISTE

MDF SKIRTING

119x18 mm



119x18 mm

Artikel-Nr.
article-no.

Farbe
colour

VE
unit

G 119 GRU

grundiert/primed (G)

10

G 119 LW

weiß lackiert/
white lacquered (RAL)

10

(RAL 9016)

Preis/Stange
price/piece

274 cm 274 cm

Lagerware	Bestellware
62,47	*

regard GRANADA

MDF SOCKELLEISTE

MDF SKIRTING

144x18 mm



144x18 mm

Artikel-Nr.
article-no.

Farbe
colour

VE
unit

G 144 GRU

grundiert/primed (G)

10

G 144 LW

weiß lackiert/
white lacquered (RAL)

10

(RAL 9016)

Preis/Stange
price/piece

274 cm 274 cm

Lagerware	Bestellware
69,97	*

regard GRANADA

MDF SOCKELLEISTE

MDF SKIRTING

169x18 mm



169x18 mm

Artikel-Nr.
article-no.

Farbe
colour

VE
unit

G 169 GRU

grundiert/primed (G)

10

G 169 LW

weiß lackiert/
white lacquered (RAL)

10

(RAL 9016)

Preis/Stange
price/piece

274 cm 274 cm

Lagerware	Bestellware
92,84	*

regard GRANADA

MDF SOCKELLEISTE

MDF SKIRTING

194x18 mm



194x18 mm

Artikel-Nr.
article-no.

Farbe
colour

VE
unit

G 194 GRU

grundiert/primed (G)

10

G 194 LW

weiß lackiert/
white lacquered (RAL)

10

(RAL 9016)

Preis/Stange
price/piece

274 cm 274 cm

Lagerware	Bestellware
99,42	*

* Preis auf Anfrage / price on request

8C

regard ANTWERPEN

MDF SOCKELLEISTE

MDF SKIRTING

69x18 mm



69x18 mm

Artikel-Nr. article-no. Farbe colour VE unit

A 69 GRU	grundiert/primed (G)	10
A 69 LW	weiß lackiert/ white lacquered (RAL 9016)	10

Preis/Stange price/piece	
274 cm	274 cm
Lagerware	Bestellware
35,45	*

regard ANTWERPEN

MDF SOCKELLEISTE

MDF SKIRTING

119x18 mm



119x18 mm

Artikel-Nr. article-no. Farbe colour VE unit

A 119 GRU	grundiert/primed (G)	10
A 119 LW	weiß lackiert/ white lacquered (RAL 9016)	10

Preis/Stange price/piece	
274 cm	274 cm
Lagerware	Bestellware
62,47	*

regard ANTWERPEN

MDF SOCKELLEISTE

MDF SKIRTING

144x18 mm



144x18 mm

Artikel-Nr. article-no. Farbe colour VE unit

A 144 GRU	grundiert/primed (G)	10
A 144 LW	weiß lackiert/ white lacquered (RAL 9016)	10

Preis/Stange price/piece	
274 cm	274 cm
Lagerware	Bestellware
69,97	*

regard ANTWERPEN

MDF SOCKELLEISTE

MDF SKIRTING

169x18 mm



169x18 mm

Artikel-Nr. article-no. Farbe colour VE unit

A 169 GRU	grundiert/primed (G)	10
A 169 LW	weiß lackiert/ white lacquered (RAL 9016)	10

Preis/Stange price/piece	
274 cm	274 cm
Lagerware	Bestellware
92,84	*

regard ANTWERPEN

MDF SOCKELLEISTE

MDF SKIRTING

194x18 mm



194x18 mm

Artikel-Nr. article-no. Farbe colour VE unit

A 194 GRU	grundiert/primed (G)	10
A 194 LW	weiß lackiert/ white lacquered (RAL 9016)	10

Preis/Stange price/piece	
274 cm	274 cm
Lagerware	Bestellware
99,42	*

* Preis auf Anfrage / price on request

regard REIMS
MDF SOCKELLEISTE
MDF SKIRTING
69x18 mm



69x18 mm

Artikel-Nr. article-no.	Farbe colour	VE unit
RE 69 GRU	grundiert/primed (G)	10
RE 69 LW	weiß lackiert/ white lacquered (RAL 9016)	10

Preis/Stange price/piece	
274 cm	274 cm
Lagerware	Bestellware
35,45	*

8C

regard REIMS
MDF SOCKELLEISTE
MDF SKIRTING
119x18 mm



119x18 mm

Artikel-Nr. article-no.	Farbe colour	VE unit
RE 119 GRU	grundiert/primed (G)	10
RE 119 LW	weiß lackiert/ white lacquered (RAL 9016)	10

Preis/Stange price/piece	
274 cm	274 cm
Lagerware	Bestellware
62,47	*

regard REIMS
MDF SOCKELLEISTE
MDF SKIRTING
144x18 mm



144x18 mm

Artikel-Nr. article-no.	Farbe colour	VE unit
RE 144 GRU	grundiert/primed (G)	10
RE 144 LW	weiß lackiert/ white lacquered (RAL 9016)	10

Preis/Stange price/piece	
274 cm	274 cm
Lagerware	Bestellware
69,97	*

regard REIMS
MDF SOCKELLEISTE
MDF SKIRTING
169x18 mm



169x18 mm

Artikel-Nr. article-no.	Farbe colour	VE unit
RE 169 GRU	grundiert/primed (G)	10
RE 169 LW	weiß lackiert/ white lacquered (RAL 9016)	10

Preis/Stange price/piece	
274 cm	274 cm
Lagerware	Bestellware
92,84	*

regard REIMS
MDF SOCKELLEISTE
MDF SKIRTING
194x18 mm



194x18 mm

Artikel-Nr. article-no.	Farbe colour	VE unit
RE 194 GRU	grundiert/primed (G)	10
RE 194 LW	weiß lackiert/ white lacquered (RAL 9016)	10

Preis/Stange price/piece	
274 cm	274 cm
Lagerware	Bestellware
99,42	*

* Preis auf Anfrage / price on request

8C

regard DRESDEN

MDF SOCKELLEISTE

MDF SKIRTING

69x18 mm



69x18 mm

Artikel-Nr. article-no.	Farbe colour	VE unit
D 69 GRU	grundiert/primed (G)	10
D 69 LW	weiß lackiert/ white lacquered (RAL 9016)	10

Preis/Stange price/piece	
274 cm	274 cm
Lagerware	Bestellware
35,45	*

regard DRESDEN

MDF SOCKELLEISTE

MDF SKIRTING

119x18 mm



119x18 mm

Artikel-Nr. article-no.	Farbe colour	VE unit
D 119 GRU	grundiert/primed (G)	10
D 119 LW	weiß lackiert/ white lacquered (RAL 9016)	10

Preis/Stange price/piece	
274 cm	274 cm
Lagerware	Bestellware
62,47	*

regard DRESDEN

MDF SOCKELLEISTE

MDF SKIRTING

144x18 mm

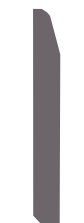

144x18 mm

Artikel-Nr. article-no.	Farbe colour	VE unit
D 144 GRU	grundiert/primed (G)	10
D 144 LW	weiß lackiert/ white lacquered (RAL 9016)	10

Preis/Stange price/piece	
274 cm	274 cm
Lagerware	Bestellware
69,97	*

regard DRESDEN

MDF SOCKELLEISTE

MDF SKIRTING

169x18 mm



169x18 mm

Artikel-Nr. article-no.	Farbe colour	VE unit
D 169 GRU	grundiert/primed (G)	10
D 169 LW	weiß lackiert/ white lacquered (RAL 9016)	10

Preis/Stange price/piece	
274 cm	274 cm
Lagerware	Bestellware
92,84	*

regard DRESDEN

MDF SOCKELLEISTE

MDF SKIRTING

194x18 mm



194x18 mm

Artikel-Nr. article-no.	Farbe colour	VE unit
D 194 GRU	grundiert/primed (G)	10
D 194 LW	weiß lackiert/ white lacquered (RAL 9016)	10

Preis/Stange price/piece	
274 cm	274 cm
Lagerware	Bestellware
99,42	*

* Preis auf Anfrage / price on request



MDF SOCKELLEISTEN weiss

MDF SKIRTINGS white

ALT WIEN MDF Sockelleiste

weiss foliert, überlackierbar
MDF skirting, white foil, overpaintable
60x19 mm

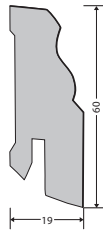

Artikel-Nr. article-no. Farbe colour VE unit

AW1960 WEISS weiß/white (W) 6

Preis/Stange price/piece

250 cm Lagerware	250 cm Bestellware
16,07	

ALT WIEN MDF Sockelleiste

weiss foliert, überlackierbar
MDF skirting, white foil, overpaintable
80x19 mm

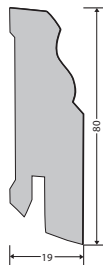

Artikel-Nr. article-no. Farbe colour VE unit

AW1980 WEISS weiß/white (W) 6

Preis/Stange price/piece

250 cm Lagerware	250 cm Bestellware
18,43	

ALT WIEN MDF Sockelleiste

weiss foliert, überlackierbar
MDF skirting, white foil, overpaintable
100x19 mm

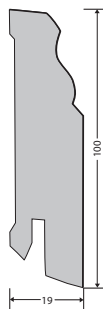

Artikel-Nr. article-no. Farbe colour VE unit

AW1910 WEISS weiß/white (W) 6

Preis/Stange price/piece

250 cm Lagerware	250 cm Bestellware
20,11	

ALT WIEN MDF Sockelleiste

weiss foliert, überlackierbar
MDF skirting, white foil, overpaintable
120x19 mm



Artikel-Nr. article-no. Farbe colour VE unit

AW1912 WEISS weiß/white (W) 6

Preis/Stange price/piece

250 cm Lagerware	250 cm Bestellware
22,36	

MODERN MDF Sockelleiste

weiss foliert, überlackierbar
 MDF skirting, white foil, overpaintable
 60x19 mm

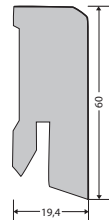

Artikel-Nr. article-no.	Farbe colour	VE unit
MO6019 WEISS	weiß/white	6

Preis/Stange price/piece	
250 cm	250 cm
Lagerware	Bestellware
18,43	

Express-Modern-
 60-Folie
 19 x 60 mm
 MDF-Träger

MODERN MDF Sockelleiste

weiss foliert, überlackierbar
 MDF skirting, white foil, overpaintable
 80x19 mm

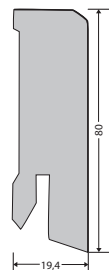

Artikel-Nr. article-no.	Farbe colour	VE unit
MO8019 WEISS	weiß/white	6

Preis/Stange price/piece	
250 cm	250 cm
Lagerware	Bestellware
16,07	

Express-Modern-
 80-Folie
 19 x 80 mm
 MDF-Träger

CLIPSTAR Befestigungsclip

für MDF Leiste Modell MODERN + ALTWIEN für 20 - 25 m
 inklusive Schrauben und Dübeln
 Blister=50 Stück
 mounting clip



Artikel-Nr. article-no.	Farbe colour	VE unit
CLIPSTAR		1

Preis/ Blister price/blister	
Lagerware	Bestellware
26,31	

SOCKELLEISTEN

MODERN MDF Sockelleiste

hochwertig, 3-fach Lackierung

Modern MDF skirting, white 3 times lacquered

60x14 mm

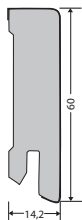

Artikel-Nr. article-no.	Farbe colour	VE unit
MO6014 WE LA	weiß/white	6

Preis/Stange price/piece	
250 cm	250 cm
Lagerware	Bestellware
	20,08

MODERN MDF Sockelleiste

hochwertig, 3-fach Lackierung

Modern MDF skirting, white 3 times lacquered

80x14 mm

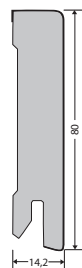

Artikel-Nr. article-no.	Farbe colour	VE unit
MO8014 WE LA	weiß/white	6

Preis/Stange price/piece	
250 cm	250 cm
Lagerware	Bestellware
	22,82

MODERN MDF Sockelleiste

hochwertig, 3-fach Lackierung

Modern MDF skirting, white 3 times lacquered

95x14 mm



Artikel-Nr. article-no.	Farbe colour	VE unit
MO9514 WE LA	weiß/white	6

Preis/Stange price/piece	
250 cm	250 cm
Lagerware	Bestellware
	24,41

MODERN MDF Sockelleiste

hochwertig, 3-fach Lackierung

Modern MDF skirting, white 3 times lacquered

120x14 mm

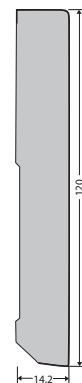

Artikel-Nr. article-no.	Farbe colour	VE unit
MO1214 WE LA	weiß/white	6

Preis/Stange price/piece	
250 cm	250 cm
Lagerware	Bestellware
	27,61

ALT WIEN MDF Sockelleiste

hochwertig, 3-fach Lackierung

Alt Wien MDF skirting, white 3 times lacquered

Höhen/height: 80 mm, 100 mm, 120 mm

Breite/width: 14 mm

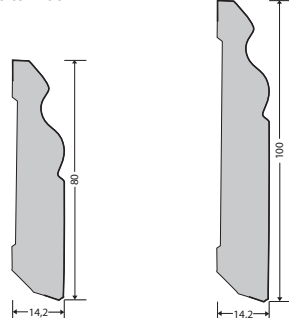

Artikel-Nr. article-no.	Farbe colour	VE unit
AW1480 WE LA	weiß/white	6
AW1410 WE LA	weiß/white	6
AW1412 WE LA	weiß/white	6

Preis/Stange price/piece	
250 cm	250 cm
Lagerware	Bestellware
	22,82
	25,06
	27,61



**FURNIERTE MASSIVSOCKELLEISTEN
MODERN**

***VENEERED WOODEN SKIRTINGS
MODERN***

8E

MODERN 40 - Edelfurnierte Holzkern Sockelleiste

Trägermaterial - massives Weichholz
 VENEERED solid wood skirting
 40x16 mm

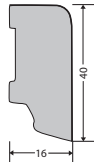

- Echtholz furnier / real wood veneer

Artikel-Nr. article-no.	Farbe colour	VE unit
MO4016 AHORN	ahorn	10
MO4016 BU GE	buche gedämpft	10
MO4016 EICHE	eiche	10
MO4016 EI WE	eiche weiß lackiert	10
MO4016 NUSS	nuss	10
MO4016 WEISS	weiß foliert	10
MO4016 WE GE	eiche weiß geölt	10

Preis/Stange price/piece	
250 cm	250 cm
Lagerware	Bestellware
15,17	
15,17	
15,17	
18,18	
16,91	
16,91	
18,18	

MODERN 58 - Edelfurnierte Holzkern Sockelleiste

Trägermaterial - massives Weichholz
 VENEERED solid wood skirting
 58x16 mm

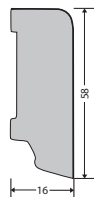

- Echtholz furnier / real wood veneer

Artikel-Nr. article-no.	Farbe colour	VE unit
MO5816 AHORN	ahorn	10
MO5816 BU GE	buche gedämpft	10
MO5816 EICHE	eiche	10
MO5816 EI WE	eiche weiß lackiert	10
MO5816 NUSS	nuss	10
MO5816 WEISS	weiß foliert	10
MO5816 WE GE	eiche weiß geölt	10

Preis/Stange price/piece	
250 cm	250 cm
Lagerware	Bestellware
18,18	
18,18	
18,18	
21,63	
20,75	
20,75	
21,63	



DREIKANT und SCHWEIZERLEISTEN

TRIANGULAR and SWISS skirtings

8F

SCHWEIZER Massivsockelleiste

lackiert oder roh
SWISS solid wood skirting
10x33 mm

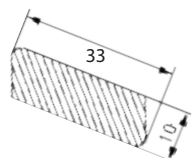

Artikel-Nr. article-no.	Farbe colour	VE unit
SL1035 EICHE	eiche	10
SL1035 EI RO	eiche roh	10
SL1035 ESCHE	esche	10
SL1035 BUCHE	buche	10
SL1035 AHORN	ahorn	10
SL1035 NUSS	nuss	10

Preis/Stange price/piece	
240 cm Lagerware	240 cm Bestellware
13,79	
13,25	
12,54	
10,89	
19,21	
23,32	

SCHWEIZER Massivsockelleiste mit DÄMMBAND

lackiert
SWISS solid wood skirting, with insulation strip
10x33 mm

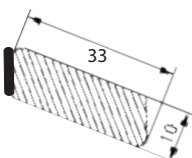

Artikel-Nr. article-no.	Farbe colour	VE unit
1035SK EICHE	eiche	10
1035SK ESCHE	esche	10

Preis/Stange price/piece	
240 cm Lagerware	240 cm Bestellware
16,45	
	15,15

DREIKANT Massivsockelleiste

lackiert oder roh
TRIANGULAR solid wood skirting
23x32 mm

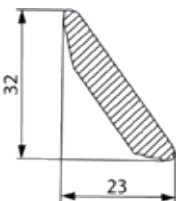

Artikel-Nr. article-no.	Farbe colour	VE unit
SL2332 EICHE	eiche	10
SL2332 EI RO	eiche roh	10
SL2332 BUCHE	buche	10

Preis/Stange price/piece	
240 cm Lagerware	240 cm Bestellware
15,65	
14,09	
11,79	

DREIKANT Massivsockelleiste mit DÄMMBAND

lackiert
TRIANGULAR solid wood skirting, with insulation strip
23x32 m

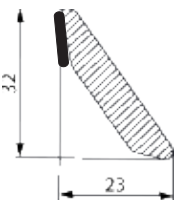

Artikel-Nr. article-no.	Farbe colour	VE unit
2332SK EICHE	eiche	10

Preis/Stange price/piece	
240 cm Lagerware	240 cm Bestellware
16,66	

BESCHICHTUNGSBAND für Holz - DÄMMBAND

selbstklebend
Insulation strip for wood - self adhesive
3x8 mm



Artikel-Nr. article-no.	Farbe colour	VE unit
DÄMMBAND	weiß	5x20 m
DÄMMBAND S	schwarz	5x20 m
DÄMMBAND BES	beschichtet	1

Preis/lfm price/m	
Lagerware	Bestellware
0,44	
0,44	
	0,69



FURNIERTE MASSIVSOCKELLEISTEN

VENEERED SOLID WOOD SKIRTINGS

SOCKELLEISTEN

EDELFURNIERTE Holzsockelleiste

Trägermaterial - massives Weichholz

Veneered solid wood skirting

28x28 mm

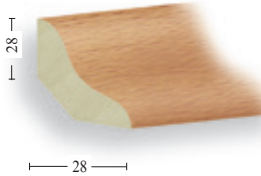

Artikel-Nr. article-no.	Farbe colour	VE unit
28 AHORN	ahorn	40
28 BUCHE	buche	40
28 EICHE	eiche	40
28 ESCHE	esche	40
28 FICHTE	fichte	40
28 KIRSCH	kirsch	40
28 NUSS	nuss	40
28 WEISS LA.	weiß foliert	40

Preis/Stange price/piece	
250 cm	250 cm
Lagerware	Bestellware
10,76	
10,76	
10,76	
10,76	
10,76	
	10,76
10,93	14,38

EDELFURNIERTE Holzsockelleiste

Trägermaterial - massives Weichholz

Veneered solid wood skirting

40x20 mm



Artikel-Nr. article-no.	Farbe colour	VE unit
4022 AHORN	ahorn	20
4022 BIRKE	birke	20
4022 BUCHE	buche	20
4022 EICHE	eiche	20
4022 FICHTE	fichte	20
4022 KIRSCH	kirsch	20
4022 LÄRCH	lärche	20
4022 NUSS	nuss	20
4022 WEISS	weiß foliert	20

Preis/Stange price/piece	
250 cm	250 cm
Lagerware	Bestellware
14,11	
14,11	14,11
14,11	
	14,11
	14,73
14,11	
14,73	
17,14	

EDELFURNIERTE Holzsockelleiste

Trägermaterial - massives Weichholz

Veneered solid wood skirting

60x20 mm



Artikel-Nr. article-no.	Farbe colour	VE unit
6022 AHORN	ahorn	20
6022 BUCHE	buche	20
6022 EICHE	eiche	20
6022 WEISS	weiß foliert	20

Preis/Stange price/piece	
250 cm	250 cm
Lagerware	Bestellware
15,22	
15,22	
15,22	
18,77	

EDELFURNIERTE Holzsockelleiste

Trägermaterial - massives Weichholz

Veneered solid wood skirting

38x19 mm

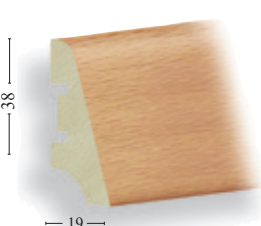

Artikel-Nr. article-no.	Farbe colour	VE unit
SL4018 AHORN	ahorn	20
SL4018 AKAZI	akazie	20
SL4018 BIRKE	birke	20
SL4018 BUCHE	buche	20
SL4018 DOUSS	doussie	20
SL4018 EI RO	eiche roh	20
SL4018 EICHE	eiche	20
SL4018 ESCHE	esche	20
SL4018 IROKO	iroko	20
SL4018 KIRSC	kirsche	20
SL4018 LÄRCH	lärche	20
SL4018 MER	merbau	20
SL4018 NUSS	nuss	20
SL4018 RAUCH	räuchereiche	20
SL4018 WE GE	eiche weiß geölt	20
SL4018 WEISS	weiß foliert	20
SL4018 WENGE	wenge	20

Preis/Stange price/piece	
250 cm	250 cm
Lagerware	Bestellware
12,18	
	26,86
	12,75
12,75	
	14,63
12,75	
12,75	
12,75	
14,63	
13,69	
12,75	
15,84	
13,69	
15,84	
15,84	
15,84	
	15,84

EDELFURNIERTE Holzsockelleiste

Trägermaterial - massives Weichholz

Veneered solid wood skirting

58x20 mm

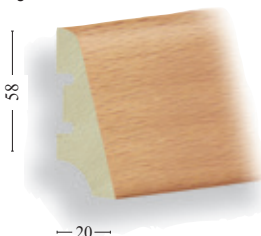

Artikel-Nr. article-no.	Farbe colour	VE unit
5820 AHORN	ahorn	20
5820 BUCHE	buche	20
5820 DOUSSIE	doussie	20
5820 EI ROH	eiche roh	20
5820 EICHE	eiche	20
5820 ESCHE	esche	20
5820 FICHTE	fichte	20
5820 KIRSCH	kirsche	20
5820 LÄRCH	lärche	20
5820 NUSS	nuss	20
5820 RAUCH	räuchereiche	20
5820 WEISS	weiß foliert	20

Preis/Stange price/piece	
250 cm	250 cm
Lagerware	Bestellware
15,95	
15,95	
	20,90
	17,62
15,95	
15,95	
	15,95
	16,68
15,95	
16,68	
15,95	
18,50	

EDELFURNIERTE Holzsockelleiste

Trägermaterial - massives Weichholz

Veneered solid wood skirting

80x15 mm

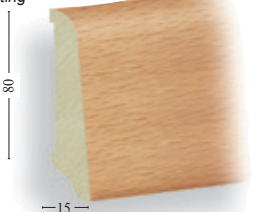

Artikel-Nr. article-no.	Farbe colour	VE unit
80 BUCHE	buche	20
80 EICHE	eiche	20
80 WEISS	weiß foliert	20

Preis/Stange price/piece	
250 cm	250 cm
Lagerware	Bestellware
19,33	
19,33	
23,72	

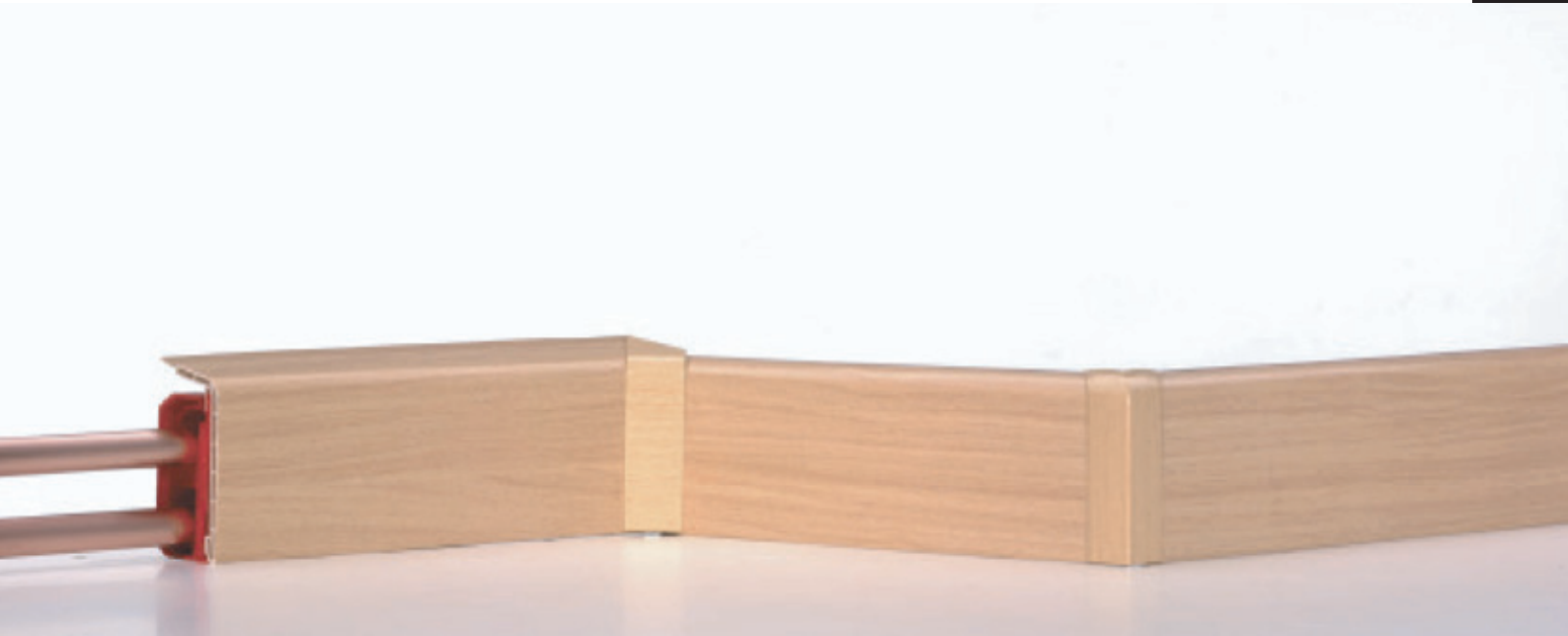

HEIZROHR SOCKELLEISTEN



HEATING TUBE SKIRTINGS

HEIZROHR SOCKELLEISTE

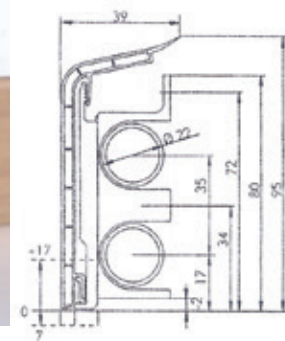
8H

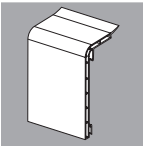
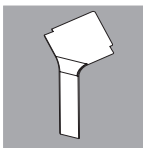
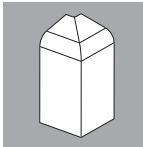
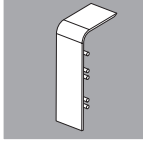
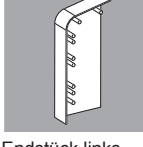

Außen- und Innenecken sind nur mit Schellen verwendbar!
Outer and inner corners can only be mounted with clamps!

	Artikel-Nr.	Beschreibung	Farbe	VE	VK Preis
 Sockelleistenprofil Skirting board	HZ2010 AHORN	SLF2000A	Sockelleiste 95x39 mm inkl. 2 Schellen 2150	ahorn	10x4m pro Stange 88,70
	HZ2011 AHORN	IE2000A	Inneneck inkl. 1 Schelle 2151D	ahorn	10 pro Stück 13,69
	HZ2012 AHORN	AE2000A	Außeneck inkl. 1 Schelle 2152D	ahorn	10 pro Stück 13,69
	HZ2013 AHORN	ST A	Stoßverbinder	ahorn	10 pro Stück 5,12
	HZ2014 AHORN	ES A li	Endstück links	ahorn	10 pro Stück 6,69
HZ2015 AHORN	ES A re	Endstück rechts	ahorn	10 pro Stück 6,69	
 Inneneck Inside corner	HZ2020 BU HL	SLF2000BH	Sockelleiste 95x39 mm inkl. 2 Schellen 2150	buche hell	10x4m pro Stange 84,77
	HZ2021 BU HL	IE2000BH	Inneneck inkl. 1 Schelle 2151D	buche hell	10 pro Stück 13,50
	HZ2022 BU HL	AE2000BH	Außeneck inkl. 1 Schelle 2152D	buche hell	10 pro Stück 13,50
	HZ2023 BU HL	ST BH	Stoßverbinder	buche hell	10 pro Stück 5,02
	HZ2024 BU HL	ES BH li	Endstück links	buche hell	10 pro Stück 6,50
HZ2025 BU HL	ES BH re	Endstück rechts	buche hell	10 pro Stück 6,50	
 Außeneck Outside corner	HZ2030 BU DK	SLF2000BD	Sockelleiste 95x39 mm inkl. 2 Schellen 2150	buche dkl	10x4m pro Stange 88,70
	HZ2031 BU DK	IE2000BD	Inneneck inkl. 1 Schelle 2151D	buche dkl	10 pro Stück 13,69
	HZ2032 BU DK	AE2000BD	Außeneck inkl. 1 Schelle 2152D	buche dkl	10 pro Stück 13,69
	HZ4133 BU DK	ST BD	Stoßverbinder	buche dkl	10 pro Stück 5,12
	HZ4134 BU DK	ES BD li	Endstück links	buche dkl	10 pro Stück 6,69
HZ4135 BU DK	ES BD re	Endstück rechts	buche dkl	10 pro Stück 6,69	
 Stossverbinder Connecting unit	HZ2060 EICHE	SLF2000EH	Sockelleiste 95x39 mm inkl. 2 Schellen 2150	eiche hell	10x4m pro Stange 79,09
	HZ2061 EICHE	IE2000EH	Inneneck inkl. 1 Schelle 2151D	eiche hell	10 pro Stück 13,42
	HZ2062 EICHE	AE2000EH	Außeneck inkl. 1 Schelle 2152D	eiche hell	10 pro Stück 13,42
	HZ163 EICHE	ST EH	Stoßverbinder	eiche hell	10 pro Stück 4,89
	HZ164 EICHE	ES EH li	Endstück links	eiche hell	10 pro Stück 6,31
HZ165 EICHE	ES EH re	Endstück rechts	eiche hell	10 pro Stück 6,31	
 Endstück links Endcap left	HZ2080 WEISS	SLF2000W	Sockelleiste 95x39 mm inkl. 2 Schellen 2150	weiß	10x4m pro Stange 66,88
	HZ2081 WEISS	IE2000W	Inneneck inkl. 1 Schelle 2151D	weiß	10 pro Stück 10,18
	HZ2082 WEISS	AE2000W	Außeneck inkl. 1 Schelle 2152D	weiß	10 pro Stück 10,18
	HZ183 WEISS	ST W	Stoßverbinder	weiß	10 pro Stück 3,26
	HZ184 WEISS	ES W li	Endstück links	weiß	10 pro Stück 4,08
HZ185 WEISS	ES W re	Endstück rechts	weiß	10 pro Stück 4,08	
 Außenschelle Outside clamp	HZ2150 D	SCH 2150	Schelle inkl. 2 Schlagdübel für Rohre bis 22 mm nach der Rohrverlegung		10 pro Stück 2,61
	HZ2151 D	IE SCH2000	Inneneckschelle inkl. 2 Schlagdübel für Rohre bis 22 mm für Winkel 85-100°		10 pro Stück 5,66
	HZ2152 D	AE SCH2000	Außeneckschelle inkl. 2 Schlagdübel für Rohre bis 22 mm für Winkel 85-100°		10 pro Stück 5,66
 Innenschelle Inside clamp					

Prospekt und Musterkoffer auf Anfrage!



SCREASY - Sockelleisten Schrauben

STAHLNÄGEL

SCREASY - skirtingboard screws

STEEL NAILS

SCREASY SCHRAUBEN SCREASY SCREWS

8I
8J

SCREASY KREUZSCHLITZ 35 mm

inklusive Bit und Dübel - SCREASY PHILLIPS Head 35 mm
BOX = 500 Stück



Artikel-Nr. article-no.	Farbe colour	Maß size	VE/BOX unit/BOX	Preis/BOX price/BOX
38813 01	weiß	3,5x35 mm	1	60,11
38813 10	nickel	3,5x35 mm	1	58,10
38813 30	messing	3,5x35 mm	1	58,10
38813 50	brüniert	3,5x35 mm	1	58,10

SCREASY KREUZSCHLITZ 45 mm

inklusive Bit und Dübel - SCREASY PHILLIPS Head 45 mm
BOX = 500 Stück



Artikel-Nr. article-no.	Farbe colour	Maß size	VE/BOX unit/BOX	Preis/BOX price/BOX
38815 01	weiß	3,5x45 mm	1	76,20
38815 10	nickel	3,5x45 mm	1	72,17
38815 30	messing	3,5x45 mm	1	72,17
38815 50	brüniert	3,5x45 mm	1	72,17

SCREASY TORX 35 mm

inklusive Bit und Dübel
BOX = 500 Stück



Artikel-Nr. article-no.	Farbe colour	Maß size	VE/BOX unit/BOX	Preis/BOX price/BOX
38873 01	weiß	3,5x35 mm	1	64,14
38873 10	nickel	3,5x35 mm	1	62,14
38873 30	messing	3,5x35 mm	1	62,14
38873 50	brüniert	3,5x35 mm	1	62,14

SCREASY TORX 45 mm

inklusive Bit und Dübel
BOX = 500 Stück



Artikel-Nr. article-no.	Farbe colour	Maß size	VE/BOX unit/BOX	Preis/BOX price/BOX
38875 01	weiß	3,5x45 mm	1	82,22
38875 10	nickel	3,5x45 mm	1	78,19
38875 30	messing	3,5x45 mm	1	78,19
38875 50	brüniert	3,5x45 mm	1	78,19

SCREASY SOLO TORX 43 mm

inklusive Bit und Bohrer
BOX = 500 Stück



Artikel-Nr. article-no.	Farbe colour	Maß size	VE/BOX unit/BOX	Preis/BOX price/BOX
38675 01	weiß	6x43 mm	1	118,57
38675 10	nickel	6x43 mm	1	99,48
38675 30	messing	6x43 mm	1	99,48
38675 50	brüniert	6x43 mm	1	99,48

ZUBEHÖR SOCKELLEISTEN

STAHLNÄGEL gehärtet

Tempered steel nails



Artikel-Nr. article-no.	VE unit	Maß size	VE unit	Preis/VE price/VE
151200 25	lose VE 1000 Stück	5x25 mm	1	16,39
151200 35	lose VE 1000 Stück	5x35 mm	1	18,39
151206 25	VE 20x100 Stück = 2000 Stück	5x25 mm	1	39,08
151206 35	VE 20x100 Stück = 2000 Stück	5x35 mm	1	44,56

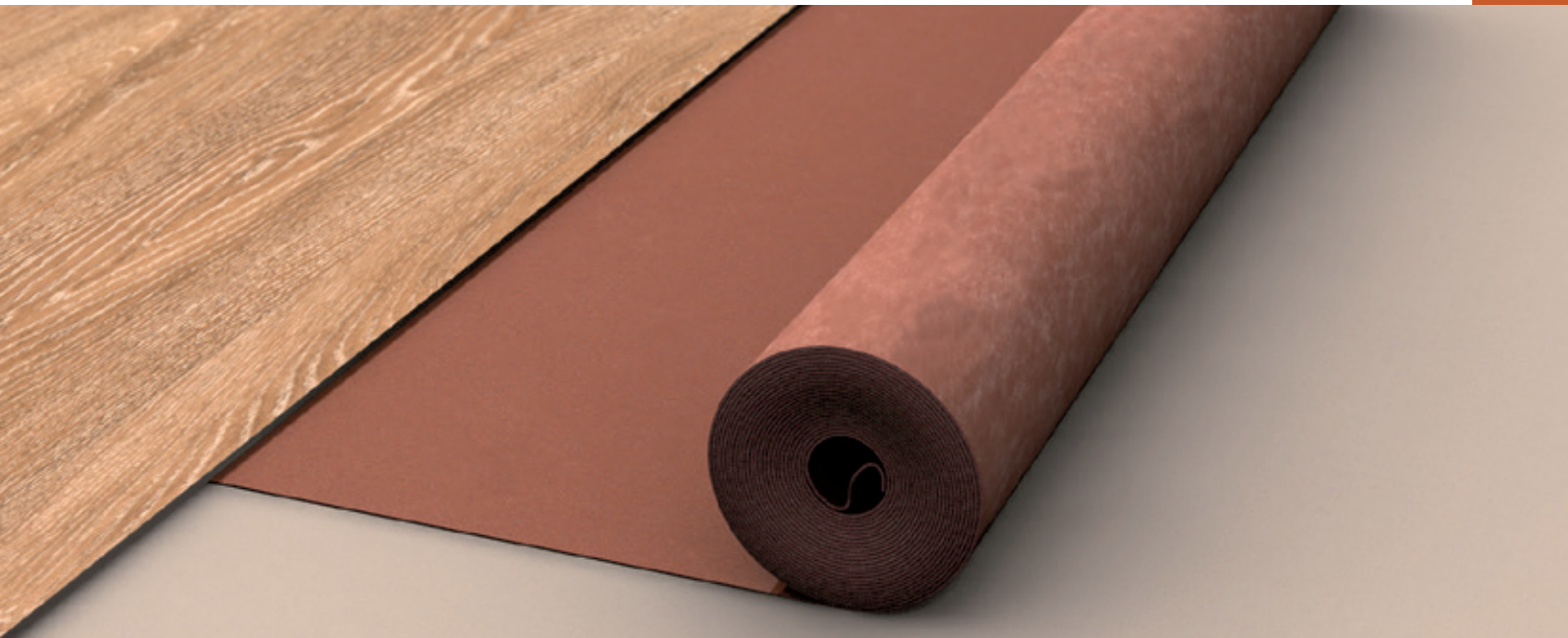

GREENWALK

GREEN WALK LVT BASIC

9A

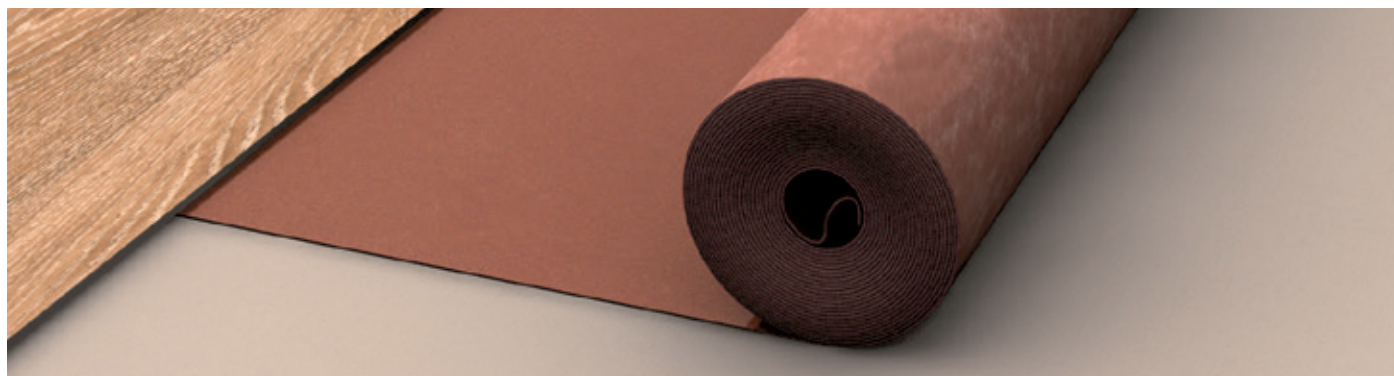

Das patentierte Akustiksystem „Green Walk LVT Basic“ wurde speziell für die schwimmende Verlegung unter clickbaren Design-Bodenbelägen konzipiert. Das hochwertige „Green Walk LVT Basic“ - Geh- und Trittschallsystem wurde nach dem modernsten Stand der Technik entwickelt und wird als handliche Rollenware geliefert.

GREEN WALK LVT BASIC

1,4mm 10x1m
VE 40 RO=400 m

Artikel-Nr. article-no.	Farbe colour	VE unit	Preis/Rolle price/roll	
			10 m ² Lagerware	10 m ² Bestellware
GW LVT BASIC		10 m ²	77,12	

Dauerelastisches Unterlagsmaterial bestehend aus mineralischen Füllstoffen sowie Polyurethan-Bindemitteln. Das „Green Walk LVT Basic“ besteht aus einer transparenten PET-Folie (perforiert), einer alterungsbeständigen Polyurethan-Schwerschicht sowie einer hochwertigen Vlies-Rückenkaschierung.

ST	Produktstärke 1,40 mm (± 0,15 mm)	RWS	Gehschallreduzierung bis zu 22 %; 6% (± 2 %)	CS	Druckfestigkeit bis zu 39 t/m ² (~ 390 kPa)
GW	Flächengewicht 1,50 kg/m ² (±0,15 kg/m ²)	IS	Trittschallreduzierung bis zu 16 dB; 14 dB (±2 dB)	CC	Statische Druckfestigkeit ~ 82 kPa
L	Produktlänge 10 m (± 15,00 mm)	R	Wärmedurchlasswiderstand 0,01 m ² K/W	DL	Dynamische Druckfestigkeit > 100.000 Zyklen
BR	Produktbreite 1 m (± 1,00 mm)	S	Wasserdampfdurchlässigkeit n.a.	RLB	Stoßbeanspruchung ~ 600 mm
		RI	Resteindruck < 0,1 mm (LVT)	PC	Punktueller Ausgleichsfähigkeit ~ 0,58 mm
				FC	Brandklassifikation Efl

GREEN WALK LVT GRIP

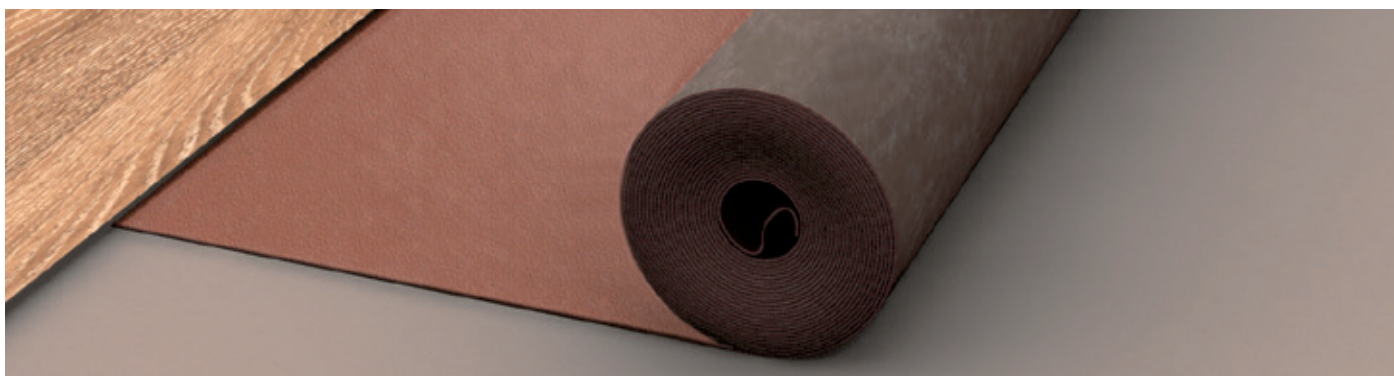

Das patentierte Akustiksystem „Green Walk LVT Grip“ wurde speziell für die schwimmende Verlegung unter clickbaren Design-Bodenbelägen konzipiert. Das hochwertige „Green Walk LVT Grip“ - Geh- und Trittschallsystem wurde nach dem modernsten Stand der Technik entwickelt und wird als handliche Rollenware geliefert.

GREEN WALK LVT GRIP

1,4mm 10x1m
VE 40 RO=400 m

Artikel-Nr. article-no.	Farbe colour	VE unit	Preis/Rolle price/roll	
			10 m ² Lagerware	10 m ² Bestellware
GW LVT GRIP		10 m ²	89,66	

Dauerelastisches Unterlagsmaterial bestehend aus mineralischen Füllstoffen sowie Polyurethan-Bindemitteln. Das „Green Walk LVT Grip“ besteht aus einem speziellen Folien-Vlies-Träger (kaschiert), einer alterungsbeständigen Polyurethan-Schwerschicht sowie einer natürlichen, rutschhemmenden Anti-Slip-Oberfläche (ohne Klebstoffzusätze).

ST	Produktstärke 1,40 mm (± 0,15 mm)	RWS	Gehschallreduzierung bis zu 22 %; 6% (± 2 %)	CS	Druckfestigkeit bis zu 44 t/m ² (~ 440 kPa)
GW	Flächengewicht 1,50 kg/m ² (±0,15 kg/m ²)	IS	Trittschallreduzierung bis zu 16 dB; 14 dB (±2 dB)	CC	Statische Druckfestigkeit ~ 88 kPa
L	Produktlänge 10 m (± 15,00 mm)	R	Wärmedurchlasswiderstand 0,01 m ² K/W	DL	Dynamische Druckfestigkeit > 100.000 Zyklen
BR	Produktbreite 1 m (± 1,00 mm)	S	Wasserdampfdurchlässigkeit n.a.	RLB	Stoßbeanspruchung ~ 650 mm
		RI	Resteindruck < 0,1 mm (LVT)	PC	Punktueller Ausgleichsfähigkeit ~ 0,62 mm
				FC	Brandklassifikation Bfl-s1

GREEN WALK LAMINAT PROFESSIONAL

9A

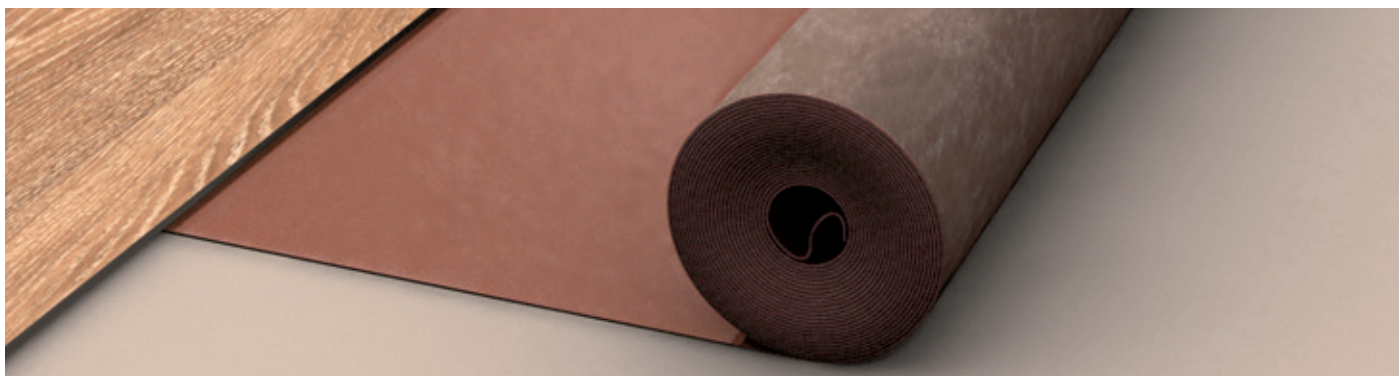

Das patentierte Akustiksystem „Green Walk Laminat Professional“ wurde speziell für die schwimmende Verlegung unter Laminat und Parkett konzipiert. Das hochwertige „Green Walk Laminat Professional“ - Geh- und Trittschallsystem besteht aus bis zu 90% natürlich vorkommenden Rohstoffen und wird als handliche Rollenware geliefert.

GREEN WALK LAMINAT PROFESSIONAL

3mm 5,5x1m
VE 40 RO=220 m

Artikel-Nr. article-no.	Farbe colour	VE unit	Preis/Rolle price/roll	
			5,5 m ² Lagerware	5,5 m ² Bestellware
GW PROF		5,5 m ²	55,64	

Dauerelastisches Unterlagsmaterial bestehend aus mineralischen Füllstoffen sowie Polyurethan-Bindemitteln. Das „Green Walk Laminat Professional“ besteht aus einer transparenten PET-Folie, einer alterungsbeständigen Polyurethan-Schwerschicht sowie einer hochwertigen Vlies-Rückencaschierung.

ST	Produktstärke 3 mm (± 0,15 mm)	RWS	Gehschallreduzierung 30 % (± 2 %)	CS	Druckfestigkeit bis zu 9 t/m ² (~ 90 kPa)
GW	Flächengewicht 2,65 kg/m ² (±0,15 kg/m ²)	IS	Trittschallreduzierung 18 dB (±2 dB)	CC	Statische Druckfestigkeit ~ 38 kPa
L	Produktlänge 5,5 m (± 15,00 mm)	R	Wärmedurchlasswiderstand 0,01 m ² K/W	DL	Dynamische Druckfestigkeit > 100.000 Zyklen
BR	Produktbreite 1 m (± 1,00 mm)	S	Wasserdampfdurchlässigkeit n. a.	RLB	Stoßbeanspruchung ~ 950 mm
				PC	Punktuelle Ausgleichsfähigkeit ~ 1,57 mm
				FC	Brandklassifikation Efl

GREEN WALK LAMINAT PROFESSIONAL ALU

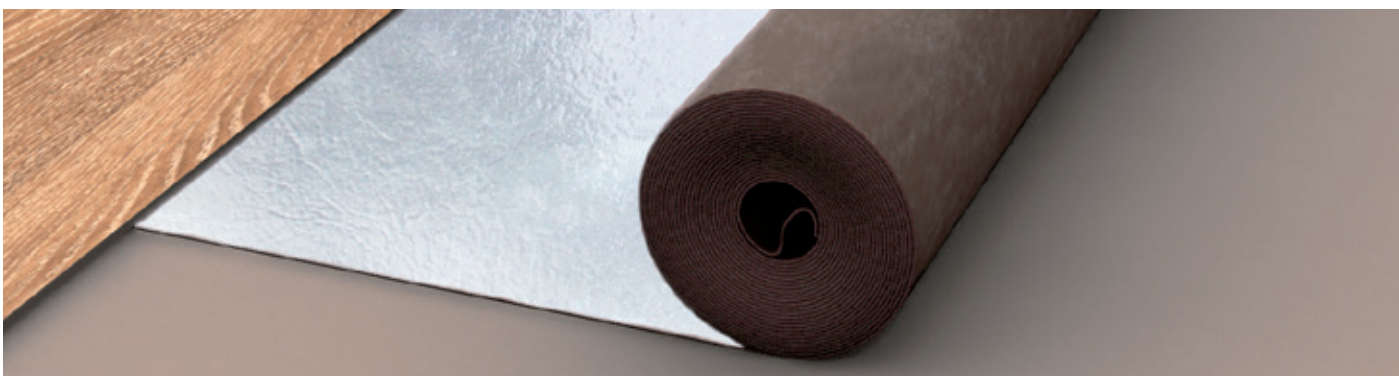

Das patentierte Akustiksystem „Green Walk Laminat Professional Alu“ wurde speziell für die schwimmende Verlegung unter Laminat und Parkett konzipiert. Das hochwertige „Green Walk Laminat Professional Alu“ - Geh- und Trittschallsystem besteht aus bis zu 90% natürlich vorkommenden Rohstoffen und wird als handliche Rollenware geliefert.

GREEN WALK LAMINAT PROFESSIONAL ALU

3 mm 5,5x1m
VE 40 RO=220 m

Artikel-Nr. article-no.	Farbe colour	VE unit	Preis/Rolle price/roll	
			5,5 m ² Lagerware	5,5 m ² Bestellware
GW PROF ALU		5,5 m ²	57,37	

Dauerelastisches Unterlagsmaterial bestehend aus mineralischen Füllstoffen sowie Polyurethan-Bindemitteln. Das „Green Walk Laminat Professional Alu“ besteht aus einer metallisierten PET-Folie (Alu), einer alterungsbeständigen Polyurethan-Schwerschicht sowie einer hochwertigen Vlies-Rückencaschierung.

ST	Produktstärke 3 mm (± 0,15 mm)	RWS	Gehschallreduzierung 30 % (± 2 %)	CS	Druckfestigkeit bis zu 9 t/m ² (~ 90 kPa)
GW	Flächengewicht 2,65 kg/m ² (±0,15 kg/m ²)	IS	Trittschallreduzierung 18 dB (±2 dB)	CC	Statische Druckfestigkeit ~ 38 kPa
L	Produktlänge 5,5 m (± 15,00 mm)	R	Wärmedurchlasswiderstand 0,01 m ² K/W	DL	Dynamische Druckfestigkeit > 100.000 Zyklen
BR	Produktbreite 1 m (± 1,00 mm)	S	Wasserdampfdurchlässigkeit > 75 m	RLB	Stoßbeanspruchung ~ 950 mm
				PC	Punktuelle Ausgleichsfähigkeit ~ 1,57 mm
				FC	Brandklassifikation Bfl-s1

GREEN WALK LAMINAT BASIC

9A

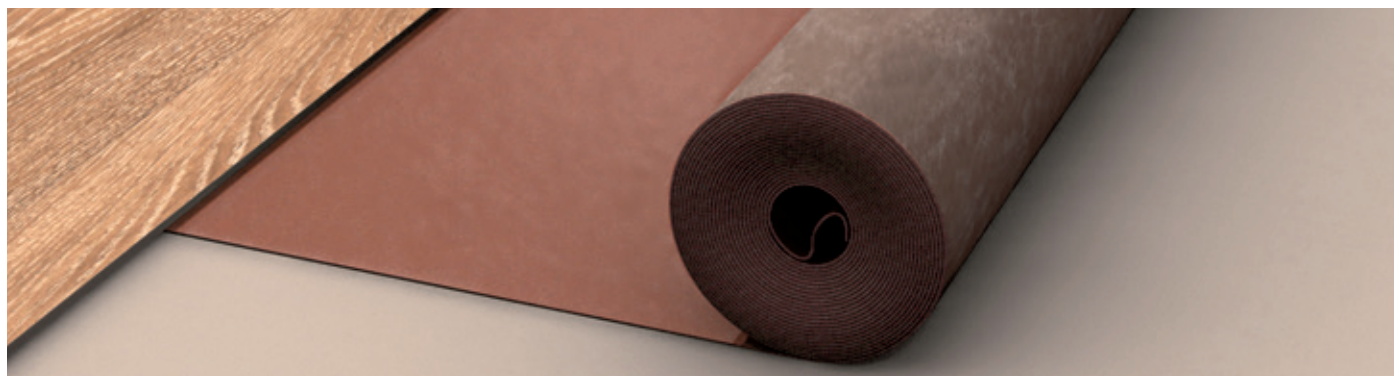

Das patentierte Akustiksystem „Green Walk Laminat Basic“ wurde speziell für die schwimmende Verlegung unter Laminat und Parkett konzipiert. Das hochwertige „Green Walk Laminat Basic“ - Geh- und Trittschallsystem besteht aus bis zu 90% natürlich vorkommenden Rohstoffen und wird als handliche Rollenware geliefert.

GREEN WALK LAMINAT BASIC

1,9mm 8,5x1m
VE 40 RO=340 m

Artikel-Nr. article-no.	Farbe colour	VE unit	Preis/Rolle price/roll	
			8,5 m ² Lagerware	8,5 m ² Bestellware
GW BASIC		8,5 m ²	63,79	

Dauerelastisches Unterlagsmaterial bestehend aus mineralischen Füllstoffen sowie Polyurethan-Bindemitteln. Das „Green Walk Laminat Basic“ besteht aus einer transparenten PET-Folie, einer alterungsbeständigen Polyurethan-Schwerschicht sowie einer hochwertigen Vlies-Rückenkaschierung.

ST	Produktstärke 1,90 mm (± 0,15 mm)	RWS	Gehschallreduzierung 24 % (± 2 %)	CS	Druckfestigkeit bis zu 19 t/m ² (~ 190 kPa)
GW	Flächengewicht 1,50 kg/m ² (±0,15 kg/m ²)	IS	Trittschallreduzierung 18 dB (±2 dB)	CC	Statische Druckfestigkeit ~ 48 kPa
L	Produktlänge 8,5 m (± 15,00 mm)	R	Wärmedurchlasswiderstand 0,01 m ² K/W	DL	Dynamische Druckfestigkeit > 100.000 Zyklen
BR	Produktbreite 1 m (± 1,00 mm)	S	Wasserdampfdurchlässigkeit n. a.	RLB	Stoßbeanspruchung ~ 750 mm
				PC	Punktuelle Ausgleichsfähigkeit ~ 1,10 mm
				FC	Brandklassifikation Efl

GREEN WALK LAMINAT BASIC ALU

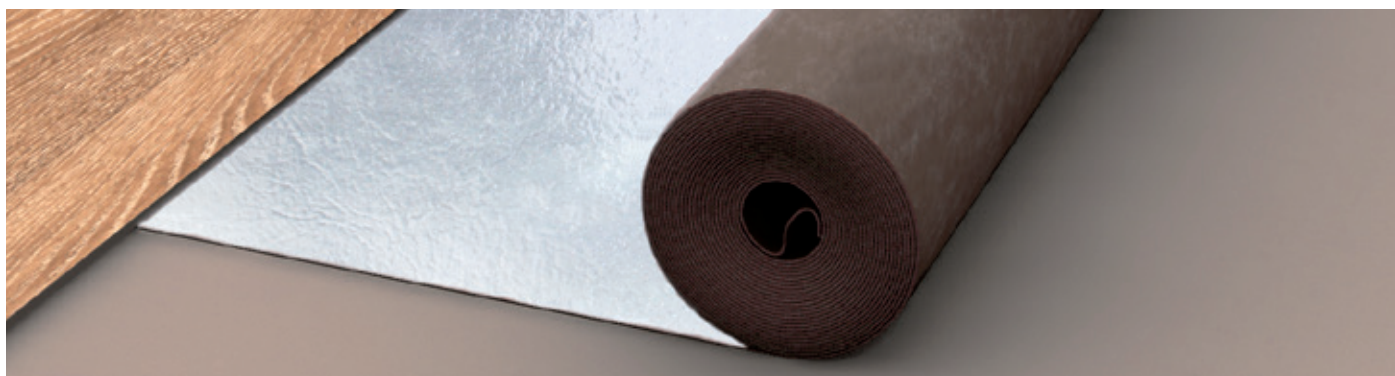

Das patentierte Akustiksystem „Green Walk Laminat Basic Alu“ wurde speziell für die schwimmende Verlegung unter Laminat und Parkett konzipiert. Das hochwertige „Green Walk Laminat Basic Alu“ - Geh- und Trittschallsystem besteht aus bis zu 90% natürlich vorkommenden Rohstoffen und wird als handliche Rollenware geliefert.

GREEN WALK LAMINAT BASIC ALU

1,9mm 8,5x1m
VE 40 RO=340 m

Artikel-Nr. article-no.	Farbe colour	VE unit	Preis/Rolle price/roll	
			8,5 m ² Lagerware	8,5 m ² Bestellware
GW BASIC ALU		8,5 m ²	67,34	

Dauerelastisches Unterlagsmaterial bestehend aus mineralischen Füllstoffen sowie Polyurethan-Bindemitteln. Das „Green Walk Laminat Basic Alu“ besteht aus einer metallisierten PET-Folie (Alu), einer alterungsbeständigen Polyurethan - Schwerschicht sowie einer hochwertigen Vlies-Rückenkaschierung.

ST	Produktstärke 1,90 mm (± 0,15 mm)	RWS	Gehschallreduzierung 24 % (± 2 %)	CS	Druckfestigkeit bis zu 19 t/m ² (~ 190 kPa)
GW	Flächengewicht 1,50 kg/m ² (±0,15 kg/m ²)	IS	Trittschallreduzierung 18 dB (±2 dB)	CC	Statische Druckfestigkeit ~ 48 kPa
L	Produktlänge 8,5 m (± 15,00 mm)	R	Wärmedurchlasswiderstand 0,01 m ² K/W	DL	Dynamische Druckfestigkeit > 100.000 Zyklen
BR	Produktbreite 1 m (± 1,00 mm)	S	Wasserdampfdurchlässigkeit > 75 m	RLB	Stoßbeanspruchung ~ 750 mm
				PC	Punktuelle Ausgleichsfähigkeit ~ 1,10 mm
				FC	Brandklassifikation Bfl-s1



AQUASTOP

SOFTFLEX „AQUASTOP“

9B



AQUASTOP BLAU Parkettunterlage

3 mm 25x1m
200 µm PE + 3 mm PEP

Artikel-Nr.
article-no.

Farbe
colour

VE
unit

Preis/Rolle
price/roll

25 m² 25 m²

Lagerware Bestellware

112,34

AQUA3/200

blau/blue

25 m²



3mm stabil-elastischer FCKW-freier Polyäthylenschaum



nach Normung gemessen ca. 18dB dämmt Trittschall



Dampfbremse durch bereits aufgeschweißte, extrafeste TYP 200 Folie bis zu max. Restfeuchtigkeit von 3%



gleicht kleine Unebenheiten aus



transportfreundlich durch geringes Gewicht und günstige Maße: 25 x 1 m = 25 m² / ca. 7 kg ca. 28 kg / m² (inkl. Folie)



geeignet bei Fußbodenheizung temperaturbeständig: von -30° bis + 90°



einfach und schnell zu verlegen (blaue Folie oben)



entspricht der Empfehlung der EPLF (Vereinigung der Europäischen Laminat-Produzenten)



durch selbstklebende Überlappung absolut anwendungssicher und dicht



absorbiert Raumschall



TOP Qualität zu fairem Preis

VORTEILE:

- keine separate Folie, da schon aufgeschweißst
- durch handliche Rollen schnell verlegt
- kein separates Klebeband, da schon vorgefertigt

SOFTFLEX „AQUAGRÜN“



AQUASTOP GRÜN Parkett- und Laminatunterlage

2 mm 25x1m
200 µm PE + 2 mm PEP

Artikel-Nr.
article-no.

Farbe
colour

VE
unit

Preis/Rolle
price/roll

25 m² 25 m²

Lagerware Bestellware

112,34

AQUAGRÜN 2

grün/green

25 m²



2mm stabil-elastischer FCKW-freier Polyäthylenschaum



nach Normung gemessen ca. 18dB dämmt Trittschall



Dampfbremse durch bereits aufgeschweißte, extrafeste TYP 200 Folie bis zu max. Restfeuchtigkeit von 3%



gleicht kleine Unebenheiten aus



transportfreundlich durch geringes Gewicht und günstige Maße: 25 x 1 m = 25 m² / ca. 9,80 kg ca. 38 kg / m² (inkl. Folie)



geeignet bei Fußbodenheizung temperaturbeständig: von -30° bis + 90°



einfach und schnell zu verlegen (grüne Folie oben)



entspricht der Empfehlung der EPLF (Vereinigung der Europäischen Laminat-Produzenten)



durch selbstklebende Überlappung absolut anwendungssicher und dicht



absorbiert Raumschall



TOP Qualität zu fairem Preis

VORTEILE:

- keine separate Folie, da schon aufgeschweißst
- durch handliche Rollen schnell verlegt
- kein separates Klebeband, da schon vorgefertigt

PRÜFZERTIFIKAT der Technischen Versuchs- und Forschungsanstalt auf Anfrage!



SOFTFLEX

PEP 210

STEAMBRAKE

SOFTFLEX® 10

9C



Geschlossenzelliger, physikalisch vernetzter Polyethylenschaumstoff, anthrazit

SOFTFLEX 10

Dicke (mm): 3 mm
Breite (mm): 1000
Rollenmass (m²): 10
Rollengewicht: ca. 1,0 kg
Dichte (kg/m³): 33 kg

Verlegung

Anwendungsbereiche:
 Verlegungsart:

Anwendungstechnische Daten

Trittschalverbesserungsmass (DIN 52210):
 Wärmeleitfähigkeit (ISO 2581):
 Wärmedurchlasswiderstand (ISO 2581):
 Flächenbelastung:
 Fußbodenheizungseignung (DIN 66095):
 Emissionen:
 Reinigung:
 Umweltinformation:

Artikel-Nr. **Farbe** VE
 article-no. **colour** unit

SOFTFLEX 10 anthrazit/*anthracite* 10 m²

Objekt, Wohnen
 lose

ca. 17 – 18 dB
 0,034 W/mK bei 10° Mitteltemperatur
 0,088 m²K/W bei 10° Mitteltemperatur
 >6600 kg/m²
 ja
 keine
 mit üblichen Reinigungsmethoden; geschlossenzellig, keine Wasseraufnahme
 Polyethylenschaumstoff, FCKW-frei hergestellt, frei von Schwermetallen, Formaldehyd

Preis/Rolle
 price/roll

10 m ²	10 m ²
Lagerware	Bestellware
49,12	

SOFTFLEX® 25



Geschlossenzelliger, physikalisch vernetzter Polyethylenschaumstoff, anthrazit

SOFTFLEX 25

Dicke (mm): 3 mm
Breite (mm): 1000
Rollenmass (m²): 25
Rollengewicht: ca. 2,40 kg
Dichte (kg/m³): 33 kg

Verlegung

Anwendungsbereiche:
 Verlegungsart:

Anwendungstechnische Daten

Trittschalverbesserungsmass (DIN 52210):
 Wärmeleitfähigkeit (ISO 2581):
 Wärmedurchlasswiderstand (ISO 2581):
 Flächenbelastung:
 Fußbodenheizungseignung (DIN 66095):
 Emissionen:
 Reinigung:
 Umweltinformation:

Artikel-Nr. **Farbe** VE
 article-no. **colour** unit

SOFTFLEX 25 anthrazit/*anthracite* 25 m²

Objekt, Wohnen
 lose

ca. 17 – 18 dB
 0,034 W/mK bei 10° Mitteltemperatur
 0,088 m²K/W bei 10° Mitteltemperatur
 >6600 kg/m²
 ja
 keine
 mit üblichen Reinigungsmethoden; geschlossenzellig, keine Wasseraufnahme
 Polyethylenschaumstoff, FCKW-frei hergestellt, frei von Schwermetallen, Formaldehyd

Preis/Rolle
 price/roll

25 m ²	25 m ²
Lagerware	Bestellware
112,34	

SOFTFLEX® 225



9C
9D

Geschlossenzelliger, physikalisch vernetzter Polyethylenschaumstoff in grün

SOFTFLEX 225

	Artikel-Nr. <i>article-no.</i>	Farbe <i>colour</i>	VE <i>unit</i>	Preis/Rolle <i>price/roll</i>	
				25 m ² Lagerware	25 m ² Bestellware
Dicke (mm):	2 mm				
Breite (mm):	1000				
Rollenmass (m²):	25				
Rollengewicht:	ca. 5,5 kg				
Dichte (kg/m³):	33 kg				
	SOFTFLEX 225	grün/ <i>green</i>	25 m ²	99,80	

Verlegung

Anwendungsbereiche:
Verlegungsart:

Objekt, Wohnen
lose

Anwendungstechnische Daten

Trittschallverbesserungsmass (DIN 52210):
Wärmeleitfähigkeit (ISO 2581):
Wärmedurchlasswiderstand (ISO 2581):
Flächenbelastung:
Fußbodenheizungseignung (DIN 66095):
Wasserdampfdiffusionswiderstandszahl μ
Emissionen:
Umweltinformation:

ca. 16 – 18 dB
0,034 W/mK bei 10° Mitteltemperatur
0,055 m²K/W bei 10° Mitteltemperatur
>66 kPa/m²
ja
(ISO 1663, 23°, 0-85% rel. Feuchtigkeitsgefälle)
keine
Polyethylenschaumstoff hergestellt ohne FCKW; frei von Schwermetallen, Formaldehyd. Entsorgung über Hausmüll möglich; recyclingfähig unter definierten Voraussetzungen.

PEP 210



Weißer PE Schaum, überlappend mit Klebeband, zur Trittschalldämmung, unter schwimmend verlegtem Fertigparkett, als Schallbremse zwischen Laminat/Parkettböden und Estrichen

KOMBI Schaumfolie weiß

	Artikel-Nr. <i>article-no.</i>	Farbe <i>colour</i>	VE <i>unit</i>	Preis/Rolle <i>price/roll</i>	
				25 m ² Lagerware	25 m ² Bestellware
Dicke (mm):	2 mm				
Breite (mm):	1000				
Rollenmass (m²):	25				
Rollengewicht:	ca. 1,5 kg				
	PEP 210P	weiß/ <i>white</i>	25 m ²	39,71	

Verlegung

Anwendungsbereiche:
Verlegungsart:

Objekt, Wohnen
lose auf den Untergrund legen, stumpf stoßen, an Stoßstellen mittels Klebeband verkleben.

Anwendungstechnische Daten

Wärmeleitfähigkeit (ISO 2581):
Fußbodenheizungseignung (DIN 66095):
Umweltinformation:

0,04 W/mK
ja, (-30 bis +90°C)
recyclebar, wasserabweisend

FRACHTPAUSCHALE: nach Vereinbarung

Nicht verträglich mit: Kaltbitumen und Bitumen, Spachtelmasse mit Lösungsmitteln, Teerprodukten, Äther, Essigester, Benzol, Xylol, Lackverdünnung, Trichloräthylen, Tetrachlorkohlenstoff, Terpentin, Wund- und Testbenzin, Normal und Superbenzin
Verwendung: zur Trittschalldämmung, unter schwimmend verlegtem Fertigparkett, als Schallbremse zwischen Laminat/Parkettböden und Estrichen

STEAMBRAKE

9E



Expandiertes, extrudiertes Polystyrol mit geschlossener Zellstruktur, zur Trittschalldämmung, unter schwimmend verlegtem Fertigparkett und Laminatböden.

STEAMBRAKE Unterlagsplatten

Dicke (mm): 3 mm
 Breite (mm): 800
 Länge (mm): 1250

Artikel-Nr.
 article-no.

Farbe
 colour

VE m²
 unit m²

Preis/Karton
 price

STEAMBRAKE grau/grey

40 m²

40 m ²	40 m ²
Lagerware	Bestellware
162,00	

Verlegung

Anwendungsbereiche:

Objekt, Wohnen

Anwendungstechnische Daten

Wärmeleitfähigkeit (ISO 2581):
 Fußbodenheizungseignung (DIN 66095):
 Umweltinformation:

0,033 W/mK
 ja, (-25 bis +85°C)
 Unverrottbar, recyclebar

Verträglich mit allen lösungsmittelfreien Stoffen



BAUFOLIE

TEPPICHSTOP

VLIES

TEPPICHSTOP

KOMFORT TEPPICHSTOP - Polyestervlies
abgepasste Ware

9F



Artikel-Nr. article-no.	Maß size	VE unit	Preis/Stück price/piece
KOM 60X130	60x130 cm	1	10,35
KOM 60X330	60x330 cm	1	22,91
KOM 80X150	80x150 cm	1	14,36
KOM 80X340	80x340 cm	1	30,76
KOM 120X190	120x190 cm	1	26,10
KOM 160X230	160x230 cm	1	39,46
KOM 190X290	190 x 290 cm	1	58,81

Hochwirksame, gleithemmende Polyestervlies-Teppichunterlage
für alle Böden mit hervorragenden Dämmeigenschaften.

Steinböden / PVC, Kork, Keramik/
Laminat / Teppichboden / Parkett lackiert und geölt

Eigenschaften:

- verhindert das Verrutschen oder Wandern des Teppichs
- hinterlässt keinerlei Rückstände
- enthält keine Weichmacher
- geeignet für Fußbodenheizung
- leicht zuzuschneiden
- hoher Trittkomfort
- schont den Teppich
- strapazierfähig
- waschbar bis 30 Grad
- TÜV geprüft

Artikel-Nr. article-no.	Maß size	VE/Rolle VE/unit	Preis/Rolle price/roll
KOMFORT 60	60 cm	30 m	172,43
KOMFORT 80	80 cm	30 m	230,11
KOMFORT 100	100 cm	30 m	287,17
KOMFORT 120	120 cm	30 m	344,22
KOMFORT 160	160 cm	30 m	459,59
KOMFORT 200	200 cm	30 m	574,33

ABDECKVLIES

PROFI ABDECKVLIES 220g/m²
Rollenbreite 1 m x 50 m



Artikel-Nr. article-no.	Maß size	VE/Rolle VE/unit	Preis/Rolle price/roll
PA-VLIES 220	1 x 50 m ²	50 m ²	74,32

BAUFOLIE

BAUFOL2/200
200 my Halbschlauch auf 1 m gerollt
Rollenbreite 2 x 25 m



Artikel-Nr. article-no.	Maß size	VE/Rolle VE/unit	Preis/Rolle price/roll
BAUFOL2/200	2 x 25 m	50 m ²	88,83



BODENSCHUTZMATTEN

FLOOR PROTECTION MATS

Büromat

Polymat - Polygrip

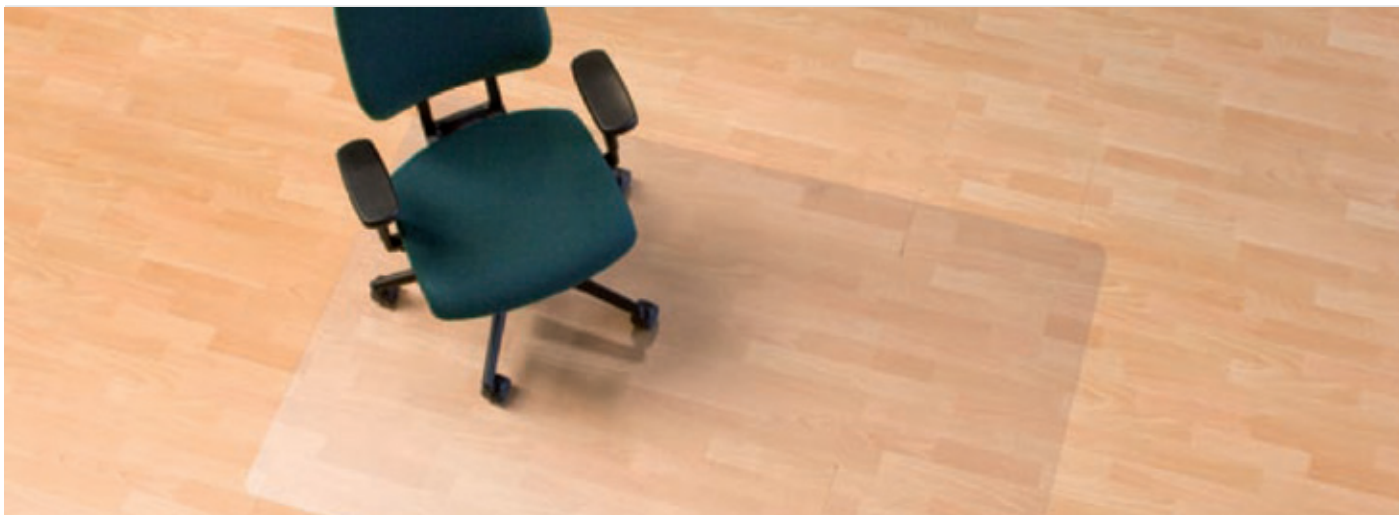

Ecoblue® – PET

ökologisch - Für harte Bodenbeläge – Mattenstärke: 1,8 mm

Eigenschaften:

- Aus umweltfreundlichen PET-Kunststoff
- Sehr transparent
- Schützt optimal vor Kratzern und Abnutzungen
- Bisphenol A(BPA) frei
- Belastbar, flexibel und verschleißfest
- Vinylfrei und geruchsneutral - frei von ausgasenden Giftstoffen
- Mit strukturierter Oberfläche
- Rutschfeste Unterseite (DIN EN ISO 13287)
- Stuhlrollenfest (DIN EN 425)
- Schwer entflammbar
- Durch Handarbeit entgratete Ecken und Kanten

BÜROMAT 1

90x120 cm



BÜROMAT No 1
Sicherheitsoberfläche

90x120 cm

Artikel-Nr.
article-no.

Maß
size

VE
unit

Preis/Stück
price/piece

BÜROMAT 1

1,8 mm

1

Lagerware	Bestellware
68,18	

BÜROMAT 2

120x120 cm



BÜROMAT No 2
Sicherheitsoberfläche

120x120 cm

Artikel-Nr.
article-no.

Maß
size

VE
unit

Preis/Stück
price/piece

BÜROMAT 2

1,8 mm

1

Lagerware	Bestellware
90,85	

BÜROMAT 3

120x150 cm



BÜROMAT No 3
Sicherheitsoberfläche

120x150 cm

Artikel-Nr.
article-no.

Maß
size

VE
unit

Preis/Stück
price/piece

BÜROMAT 3

1,8 mm

1

Lagerware	Bestellware
113,59	

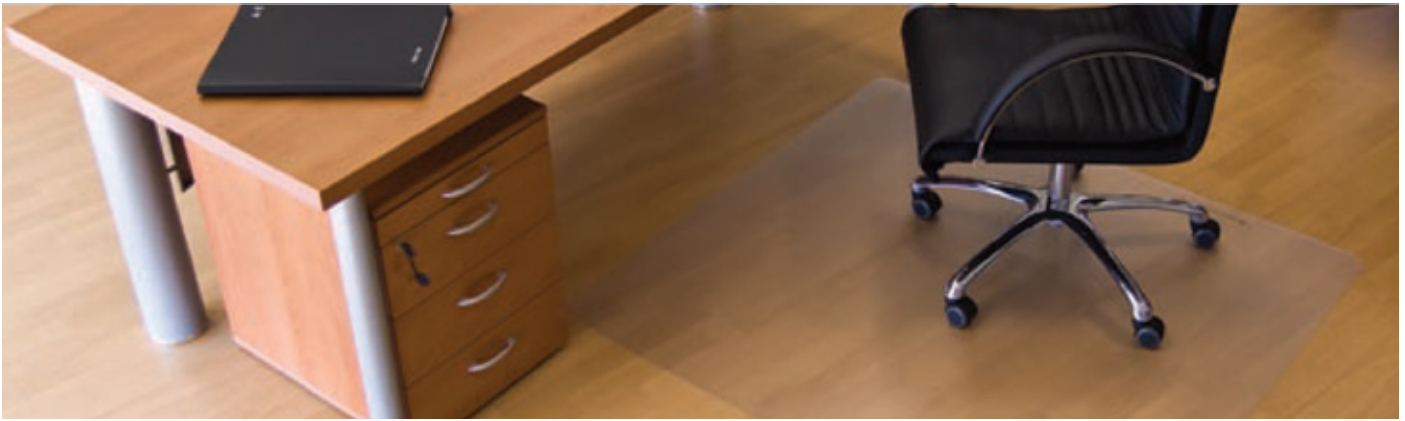

Ecogrip® – Makrolon®

robust - Für harte Bodenbeläge – Mattenstärke: 1,8 mm

Eigenschaften:

- 2 Jahre Garantie auf Bruchsicherheit
- Belastbar und verschleißfest
- Aus transparentem Makrolon®
- 100% PC-Recyclat, vollständig recyclebar
- Vinylfrei und geruchsneutral – frei von ausgasenden Giftstoffen
- Stuhlrollenfest (DIN EN 425)
- Rutschfest: Oberfläche (R9, DIN 51130), Unterseite (DIN EN ISO 13287)
- Schwer entflammbar (DIN EN 13501-1)
- Mit kratzfester strukturierter Oberfläche

POLYMAT 100

90x120 cm



90x120 cm

Artikel-Nr. article-no.	Maß size	VE unit
POLYMAT 100	1,8 mm	1

Preis/Stück price/piece
89,10

POLYMAT 200

120x120 cm



120x120 cm

Artikel-Nr. article-no.	Maß size	VE unit
POLYMAT 200	1,8 mm	1

Preis/Stück price/piece
118,77

POLYMAT 300

120x150 cm



120x150 cm

Artikel-Nr. article-no.	Maß size	VE unit
POLYMAT 300	1,8 mm	1

Preis/Stück price/piece
148,54

POLYMAT 400

mit Lasche

120x150 cm



120x150 cm

Artikel-Nr. article-no.	Maß size	VE unit
POLYMAT 400	1,8 mm	1

Preis/Stück price/piece
148,54

POLYMAT 500

120x200 cm



120x200 cm

Artikel-Nr. article-no.	Maß size	VE unit
POLYMAT 500	1,8 mm	1

Preis/Stück price/piece
198,03

POLYMAT 701

SONDERGRÖSSE

bis 120x600 cm



Artikel-Nr. article-no.	Maß size	VE unit
POLYMAT 701	1,8 mm	1

**auf Anfrage
order on request**



Ecogrip® – Makrolon®

robust - Für hochflorige Teppiche – Mattenstärke: 1,8 mm, Noppenlänge: ca. 4,5 mm

Eigenschaften:

- 2 Jahre Garantie auf Bruchsicherheit
- Belastbar und verschleißfest
- Aus transparentem Makrolon®
- 100% PC-Recyclat, vollständig recyclebar
- Vinylfrei und geruchsneutral – frei von ausgasenden Giftstoffen
- Stuhlrollenfest (DIN EN 425)
- Rutschfest: Oberfläche (R9, DIN 51130), Unterseite (DIN EN ISO 13287)
- Schwer entflammbar (DIN EN 13501-1)
- Mit kratzfester strukturierter Oberfläche

POLYGRIP 1000

90x120 cm



90x120cm

Artikel-Nr.
article-no.

Maß
size

VE
unit

POLYGRIP1000

1,8 mm x 4,5 mm

1

Preis/Stück
price/piece

Lagerware	Bestellware
98,38	

POLYGRIP 2000

120x120 cm

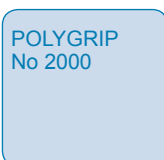

120x120 cm

Artikel-Nr.
article-no.

Maß
size

VE
unit

POLYGRIP2000

1,8 mm x 4,5 mm

1

Preis/Stück
price/piece

Lagerware	Bestellware
131,42	

POLYGRIP 3000

120x150 cm

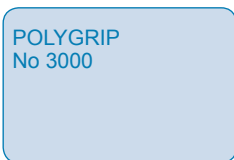

120x150 cm

Artikel-Nr.
article-no.

Maß
size

VE
unit

POLYGRIP3000

1,8 mm x 4,5 mm

1

Preis/Stück
price/piece

Lagerware	Bestellware
167,53	

POLYGRIP 4000

mit Lasche
120x150 cm

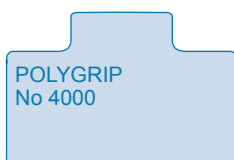

120x150 cm

Artikel-Nr.
article-no.

Maß
size

VE
unit

POLYGRIP4000

1,8 mm x 4,5 mm

1

Preis/Stück
price/piece

Lagerware	Bestellware
	167,53

POLYGRIP 5000

120x200 cm



120x200 cm

Artikel-Nr.
article-no.

Maß
size

VE
unit

POLYGRIP5000

1,8 mm x 4,5 mm

1

Preis/Stück
price/piece

Lagerware	Bestellware
	225,24



TERRASOL - BODENFLIESE

TERRASOL - FLOOR TILE

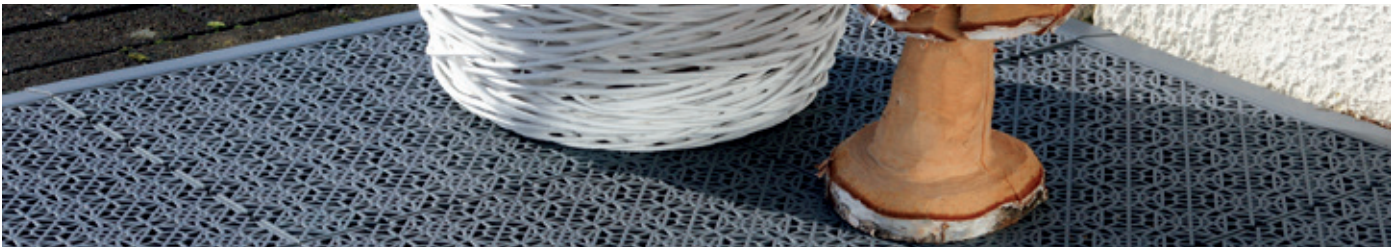

TERRA SOL

BODENFLIESEN IM CLICK-SYSTEM



Col 6020 hellgrau

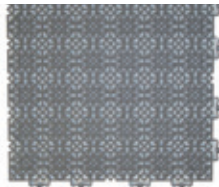

Col 6023 dunkelgrau

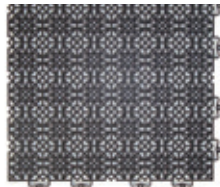

Col 6024 schwarz

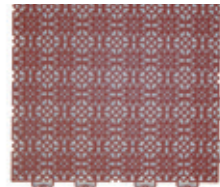

Col 6022 terracotta



Col 6021 grün

TERRA SOL Bodenfliese

TERRA SOL floor tile

Technische Daten:

Material:	Polypropylen
Grösse Fliese:	380 x 380 mm
Stärke Fliese:	10 mm
Gewicht:	2,45 kg/m ²
Box:	7 Fliesen = 1m ²
Palette:	108 m ²
Belastbarkeit:	bis 10 to / m ²

Artikel-Nr. article-no.	Farbe colour	VE/m ² unit/m ²
TER SOL HGR	hellgrau/light grey	1
TER SOL DGR	dunkelgrau/dark grey	1
TER SOL TERA	terracotta/terracotta	1
TER SOL SCHW	schwarz/black	1
TER SOL GRÜN	grün/green	1

Preis/m²
price/m²

Lagerware	Bestellware
32,77	
32,77	
32,77	
	32,77
32,77	

Bestellware = 1 Palette 108 m²

TERRA SOL Kantenleiste

TERRA SOL edge strip

Länge: 380 mm

1 Blister = 2 Stück



Artikel-Nr. article-no.	Farbe colour	VE unit
TER S K HGR	hellgrau/light grey	1
TER S K DGR	dunkelgrau/dark grey	1
TER S K TERA	terracotta/terracotta	1
TER S K SCHW	schwarz/black	1
TER S K GRÜN	grün/green	1

Preis/Blister
price/blister

Lagerware	Bestellware
4,16	
4,16	
4,16	
	4,16
4,16	

TERRA SOL Kantenleiste mit Eck

TERRA SOL edge strip with corner

Länge: 430 mm

1 Blister = 2 Stück



Artikel-Nr. article-no.	Farbe colour	VE unit
TER S E HGR	hellgrau/light grey	1
TER S E DGR	dunkelgrau/dark grey	1
TER S E TERA	terracotta/terracotta	1
TER S E SCHW	schwarz/black	1
TER S E GRÜN	grün/green	1

Preis/Blister
price/blister

Lagerware	Bestellware
4,16	
4,16	
4,16	
	4,16
4,16	

EIGENSCHAFTEN

- Klicksystem einfache Verlegung
- Sehr pflegeleicht
- UV-beständig
- Temperaturresistent, kein Deformieren bei Kälte-Wärmeeinfluss
- Wasserdrainage
- Gute chemische Beständigkeit
- Rutschklasse 9 H

EINSATZMÖGLICHKEITEN

- Balkon / Terrasse
- Hobbyraum
- Keller / Waschraum
- Kreuzfahrtschiff / Boot
- Schwimmbäder / Pool
- Ausstellungen
- Fabriken

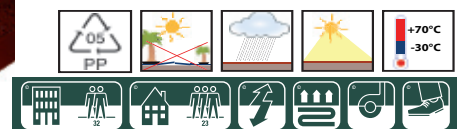
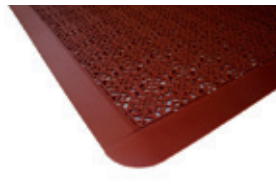
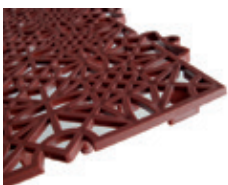

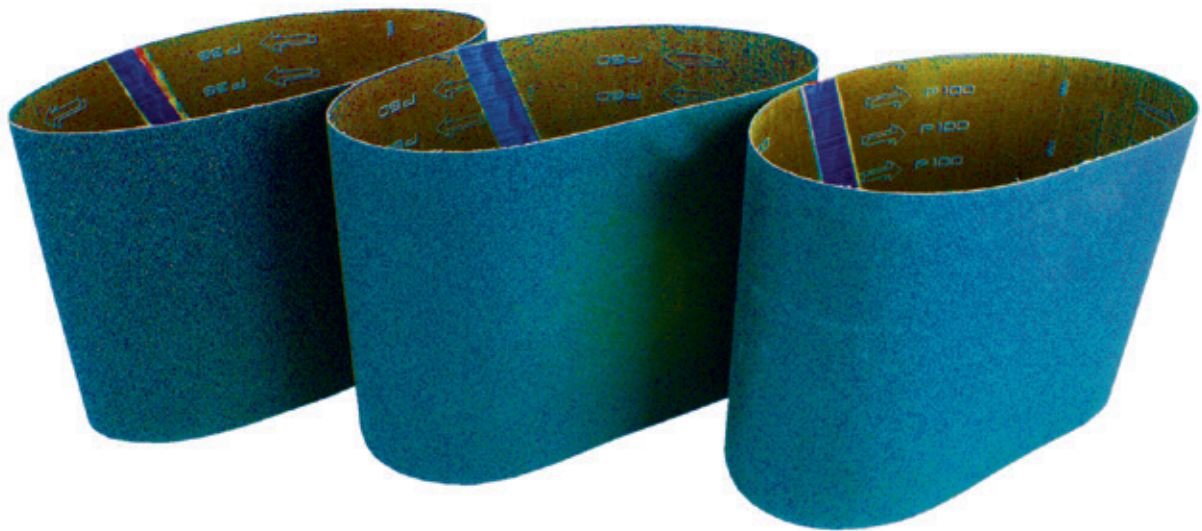

SCHLEIFBÄNDER

SCHLEIFSCHEIBEN

SCHLEIFPAPIER und GITTER

ABRASIVES

SCHLEIFBÄNDER

10A

SCHLEIFBAND - Siliziumcarbid

Abrasive belt - silicon carbide

200x750 mm



Artikel-Nr. article-no.	Material material	Körnung granularity	VE unit	Preis/Stück price/piece
73110 24	Siliziumcarbid	24	10	6,10
73110 36	Siliziumcarbid	36	10	5,98
73110 40	Siliziumcarbid	40	10	5,50
73110 60	Siliziumcarbid	60	10	5,00
73110 80	Siliziumcarbid	80	10	4,85
73110 100	Siliziumcarbid	100	10	4,66
73110 120	Siliziumcarbid	120	10	4,51

Lagerware	Bestellware

SCHLEIFBAND-Zirkonkorund

Abrasive belt - zirconium corundum

200x750 mm

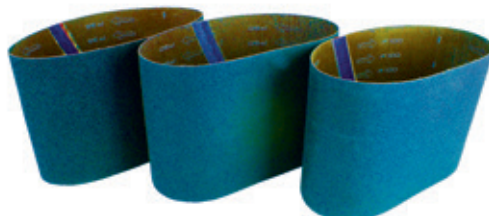

Artikel-Nr. article-no.	Material material	Körnung granularity	VE unit	Preis/Stück price/piece
221022024	Zirkonkorund	24	10	11,10
221022036	Zirkonkorund	36	10	9,74
221022040	Zirkonkorund	40	10	9,11
221022060	Zirkonkorund	60	10	8,07
221022080	Zirkonkorund	80	10	7,54
221022100	Zirkonkorund	100	10	7,15
221022120	Zirkonkorund	120	10	6,98

Lagerware	Bestellware

SCHLEIFBAND-Zirkonkorund

Abrasive belt - zirconium corundum

200x551 mm

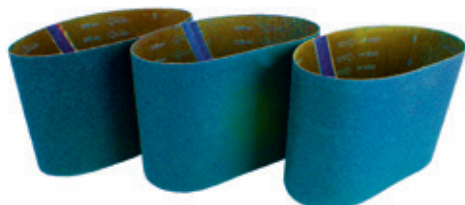

Artikel-Nr. article-no.	Material material	Körnung granularity	VE unit	Preis/Stück price/piece
221050024	Zirkonkorund	24	10	10,58
221050036	Zirkonkorund	36	10	9,30
221050040	Zirkonkorund	40	10	8,67
221050060	Zirkonkorund	60	10	7,80
221050080	Zirkonkorund	80	10	7,19
221050100	Zirkonkorund	100	10	6,71
221050120	Zirkonkorund	120	10	6,50

Lagerware	Bestellware

SCHLEIFSCHEIBEN und SCHLEIFGITTER

10B
10C**SCHLEIFSCHEIBE - mit Klett/Loch 8 mm**

Abrasive Disc

150 mm



Artikel-Nr. article-no.	Material material	Körnung granularity	VE unit
235031024	Zirkonkorund	24	50
235031036	Zirkonkorund	36	50
235031040	Zirkonkorund	40	50
235031060	Zirkonkorund	60	50
235031080	Zirkonkorund	80	50
235031100	Zirkonkorund	100	50
235031120	Zirkonkorund	120	50

Preis/Stück
price/piece

Lagerware	Bestellware
	2,28
	2,11
	1,88
	1,76
	1,76
	1,67
	1,48

SCHLEIFSCHEIBE - mit Klett/Loch 8 mm

Abrasive Disc

150 mm

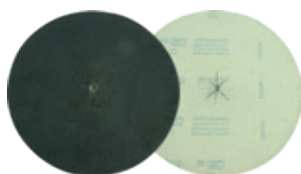

Artikel-Nr. article-no.	Material material	Körnung granularity	VE unit
73310 36	Siliciumcarbid	36	50
73310 40	Siliciumcarbid	40	50
73310 60	Siliciumcarbid	60	50
73310 80	Siliciumcarbid	80	50
73310 100	Siliciumcarbid	100	50
73310 120	Siliciumcarbid	120	50
73310 150	Siliciumcarbid	150	50

Preis/Stück
price/piece

Lagerware	Bestellware
	1,02
	0,98
	0,98
	0,92
	0,92
	0,92
	0,92

SCHLEIFSCHEIBE - mit Klett/Loch 22 mm

Abrasive Disc

180 mm

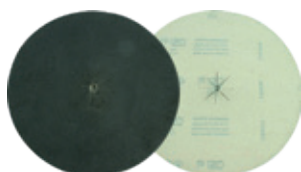

Artikel-Nr. article-no.	Material material	Körnung granularity	VE unit
73340 36	Siliciumcarbid	36	50
73340 40	Siliciumcarbid	40	50
73340 60	Siliciumcarbid	60	50
73340 80	Siliciumcarbid	80	50
73340 100	Siliciumcarbid	100	50
73340 120	Siliciumcarbid	120	50
73340 150	Siliciumcarbid	150	50

Preis/Stück
price/piece

Lagerware	Bestellware
	1,32
	1,23
	1,19
	1,19
	1,19
	1,19
	1,19

SCHLEIFSCHEIBE-Siliciumcarbid doppelseitig

Abrasive Disc - silicon carbide, double sided

400 mm



Artikel-Nr. article-no.	Material material	Körnung granularity	VE unit
441416	Siliciumcarbid doppels.	16	10
441424	Siliciumcarbid doppels.	24	10
441440	Siliciumcarbid doppels.	40	10
441460	Siliciumcarbid doppels.	60	10
441480	Siliciumcarbid doppels.	80	10
441410	Siliciumcarbid doppels.	100	10
441412	Siliciumcarbid doppels.	120	10

Preis/Stück
price/piece

Lagerware	Bestellware
	21,00
	14,90
	14,69
	12,87
	12,44
	10,85
	10,39

SCHLEIFGITTER

Abrasive Disc

400 mm

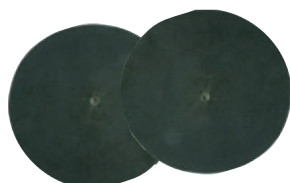

Artikel-Nr. article-no.	Material material	Körnung granularity	VE unit
441206		60	10
441208		80	10
441210		100	10
441212		120	10
441215		150	10
441218		180	10

Preis/Stück
price/piece

Lagerware	Bestellware
	5,66
	5,66
	5,66
	5,66
	5,66
	5,66



HANDSCHABER und KLINGEN
KLINGEN
MESSER

SCRAPERS
BLADES
KNIVES

SCHABER

11A

BLUE MARLIN Handschaber

Chromstahl mit ergonomisch geformtem Handgriff

Blue Marlin scraper
 Chrome steel with ergonomic handle

100 mm Klingenbreite



Artikel-Nr.
 article-no.

Material
 material

VE
 unit

Preis/Stück
 price/piece

141570000

1

Lagerware	Bestellware
46,06	

BLUE MARLIN Schaber-Ersatzklingen

Klinge aus gebläutem Stahl - 0,7 mm-Materialstärke
 Verpackt in blauer Aluminium Dose

Blue Marlin scraper blades - 0,7 mm material thickness
 Blade blued steel in blue aluminium box

Stärke 0,7 mm, Breite 100 mm Klingenbreite
 BOX=20 Klingen



Artikel-Nr.
 article-no.

Material
 material

VE/Box
 unit/box

Preis/Box
 price/box

361004195

1

Lagerware	Bestellware
82,87	

BLUE MARLIN Drehgriffschaber

Chromstahl mit ergonomisch, bewährtem Drehverschluss,
 zur Befestigung der Klinge

Blue Marlin turning handle scraper
 Chrome steel with proven turning shutter to fix the blade

100 mm Klingenbreite



Artikel-Nr.
 article-no.

Maße
 size

VE
 unit

Preis/Stück
 price/piece

141610000

350 x 110 x 35 mm

1

Lagerware	Bestellware
43,64	

Schaber Ersatzklingen

Klingen f. Abscherschaber
 Blister = 10x10 = 100 Klingen

Replacement blades for scrapers

100 mm Klingenbreite

Artikel-Nr.
 article-no.

Maße
 size

VE/Bl
 unit/bl

Preis/Blister
 price/blister

127901

10

Lagerware	Bestellware
6,54	

Handschaber ROBUST

Klingen gehärt. Spezialstahl

Hand-scraper ROBUST

100 mm Klingenbreite



Artikel-Nr.
 article-no.

Maße
 size

VE
 unit

Preis/Stück
 price/piece

412010

1

Lagerware	Bestellware
133,20	

ERSATZKLINGEN

für 412010

Replacement blade for 412010

100 mm Klingenbreite

Artikel-Nr.
 article-no.

Maße
 size

VE
 unit

Preis/Stück
 price/piece

412110

1

Lagerware	Bestellware
23,53	

KLINGEN

11B

TRAPEZKLINGE Professional

Solingen-Qualität
Blister = 10 x 10 = 100 Klingen

Professional straight utility blade

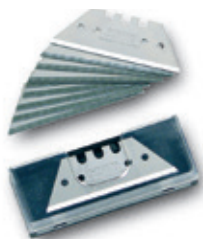

Artikel-Nr. article-no.	Maße size	VE/BI unit/bl	Preis/Blister price/blister
411000	60 x 18,9 x 0,63	10	3,55

TRAPEZKLINGE

Hochleistungsstahl, titanbeschichtet
0,65 mm
BOX = 100 Klingen

Straight blade
Hard material coating of titanium

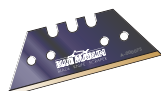

Artikel-Nr. article-no.	Maße size	VE/Box unit/box	Preis/Box price/box
361004503		1	67,70

HAKENKLINGE Professional

Solingen-Qualität
Blister = 10 x 10 = 100 Klingen

Professional hook blade



Artikel-Nr. article-no.	Maße size	VE/BI unit/bl	Preis/Blister price/blister
411200	51 x 18,9 x 0,63	10	5,96

HAKENKLINGE klein

Hochleistungsstahl, titanbeschichtet
0,65 mm
BOX = 100 Klingen

Hook blade small
Hard material coating of titanium

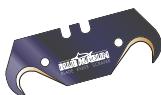

Artikel-Nr. article-no.	Maße size	VE/Box unit/box	Preis/Box price/box
361004103		1	90,10

HAKENKLINGE gross Professional

Solingen-Qualität
Blister = 10 x 10 = 100 Klingen

Professional hook blade big



Artikel-Nr. article-no.	Maße size	VE/BI unit/bl	Preis/Blister price/blister
411400	55 x 18,9 x 0,63	10	7,32

HAKENKLINGE gross

Hochleistungsstahl, titanbeschichtet
0,65 mm
BOX = 100 Klingen

Hook blade big
Hard material coating of titanium



Artikel-Nr. article-no.	Maße size	VE/Box unit/box	Preis/Box price/box
361004105		1	113,57

KLINGEN

11B

ABBRECHKLINGE Professional

Solingen-Qualität
Blister = 10x10 = 100 Klengen
18 mm

Snap-off blades



Artikel-Nr.
article-no.

311402

VE/BI
unit/bl

10

Preis/Blister
price/blister

Lagerware	Bestellware
6,50	

ABBRECHKLINGE Professional

Solingen-Qualität
Blister = 10x20 = 200 Klengen
9 mm

Snap-off blades



Artikel-Nr.
article-no.

311302

VE/BI
unit/bl

20

Preis/Blister
price/blister

Lagerware	Bestellware
4,62	

ABBRECHKLINGE Panther

Blister = 10x10 = 100 Klengen
18 mm

Snap-off blades



Artikel-Nr.
article-no.

311405
311405 SB

Blister: 10 Stück 10x10 = 100 Stück
Blister: 10 Stück 20xSB = 200 Stück

VE/BI
unit/bl

10
20

Preis/Blister
price/blister

Lagerware	Bestellware
2,88	
3,22	

ABBRECHKLINGE Panther

Blister = 10x10 = 100 Klengen
9 mm

Snap-off blades



Artikel-Nr.
article-no.

311305
311305 SB

Blister: 10 Stück 10x10 = 100 Stück
Blister: 10 Stück 20xSB = 200 Stück

VE/BI
unit/bl

10
20

Preis/Blister
price/blister

Lagerware	Bestellware
1,32	
2,91	

ABBRECHKLINGEN

Hochleistungsstahl, titanbeschichtet
18 mm
9 mm
BOX = 100 Klengen
Snap-off blades
Hard material coating of titanium

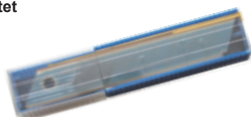

Artikel-Nr.
article-no.

361004808
361004913

Maße
size
18 mm
9 mm

VE/Box
unit/box

1
1

Preis/Box
price/box

Lagerware	Bestellware
105,02	
83,10	

MESSER

11C

BLUE MARLIN Messer neutral

mit Kunststoffköcher, einfaches Wechseln der Klingen für alle Universalklingen

*Blue Marlin knife with plastic holder
easy exchanging of blades
for all types of universal blades*



Artikel-Nr. article-no.	Maße size	VE unit	Preis/Stück price/piece				
409601	200x50x40 mm	20	<table border="1"> <thead> <tr> <th>Lagerware</th> <th>Bestellware</th> </tr> </thead> <tbody> <tr> <td>28,51</td> <td></td> </tr> </tbody> </table>	Lagerware	Bestellware	28,51	
Lagerware	Bestellware						
28,51							

BLUE MARLIN Messer Carbon Edition

mit Kunststoffköcher, einfaches Wechseln der Klingen für alle Universalklingen

*Blue Marlin knife with plastic holder
Carbon edition
easy exchanging of blades
for all types of universal blades*



Artikel-Nr. article-no.	Maße size	VE unit	Preis/Stück price/piece				
409613	200x50x40 mm	20	<table border="1"> <thead> <tr> <th>Lagerware</th> <th>Bestellware</th> </tr> </thead> <tbody> <tr> <td>32,77</td> <td></td> </tr> </tbody> </table>	Lagerware	Bestellware	32,77	
Lagerware	Bestellware						
32,77							

BLUE MARLIN Abbrechklingenmesser

mit Kunststoffköcher, für Abbrechklingen 18 mm

*Blue Marlin knife with plastic holder
for segmented blades 18 mm incl. holster*

18 mm



Artikel-Nr. article-no.	Maße size	VE unit	Preis/Stück price/piece				
341690000		20	<table border="1"> <thead> <tr> <th>Lagerware</th> <th>Bestellware</th> </tr> </thead> <tbody> <tr> <td>21,28</td> <td></td> </tr> </tbody> </table>	Lagerware	Bestellware	21,28	
Lagerware	Bestellware						
21,28							

CUTTER

11C

TECHNO Cutter Professional

Gehäuse aus rostfreiem Material

9 mm



Artikel-Nr. article-no.	Material material	VE unit	Preis/Stück price/piece
314000	9 mm	12	4,72

PANTHER red line, Metallcutter

2 Komponenten-Griff

9 mm



Artikel-Nr. article-no.	Material material	VE unit	Preis/Stück price/piece
314201	9 mm	12	4,80

PANTHER red line, Cutter, Color

Kunststoffgehäuse
Karton sortiert in den Farben:
rot, blau, grün
18 mm



Artikel-Nr. article-no.	Material material	VE unit	Preis/Stück price/piece
314208	18 mm	24	5,84

TECHNO-Cutter 18mm L-650

Schlagfestes Kunststoffgehäuse

18 mm



Artikel-Nr. article-no.	Material material	VE unit	Preis/Stück price/piece
314002	18 mm	12	9,28

OLFA Cutter OF 18mm

Schlagfestes Kunststoffgehäuse mit Teppichdrückvorrichtung

18 mm



Artikel-Nr. article-no.	Material material	VE unit	Preis/Stück price/piece
OLFA CUTTER	18 mm	6	20,56

VIERTELMONDMESSER

mit japanischem Spezialstahl, inkl. Schweissnahtschlitten+Etui

Quarter-moon knife with pouch



Artikel-Nr. article-no.	Material material	VE unit	Preis/Stück price/piece
64410000		1	52,63

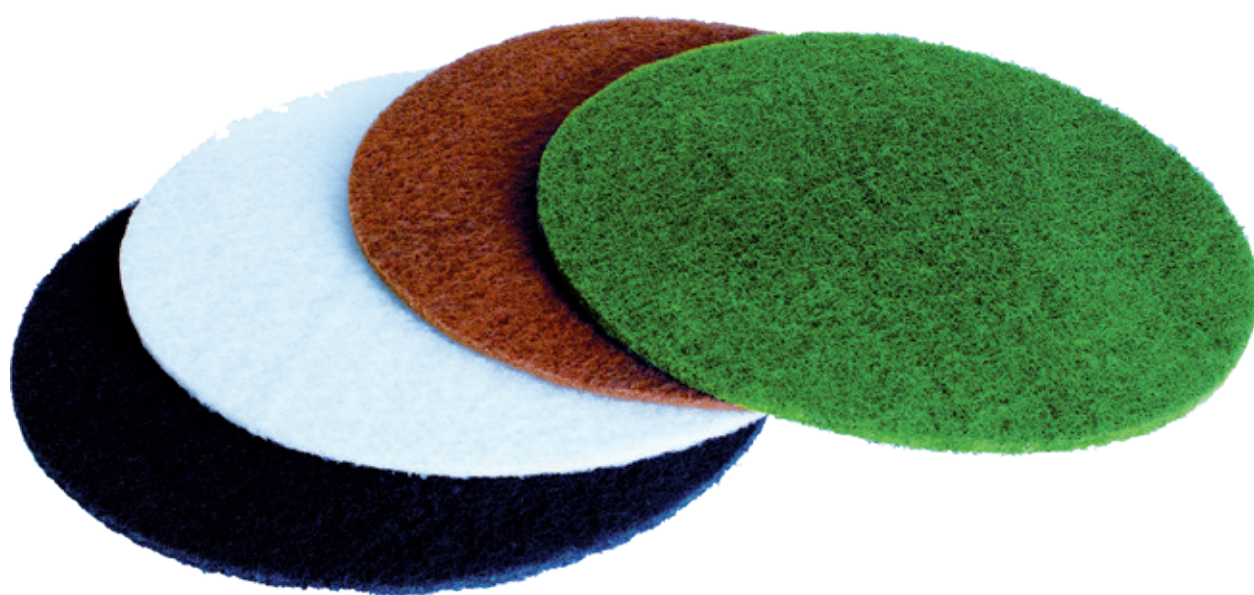

**REINIGUNGSPADS
PINSEL**

***CLEANING PADS
BRUSHES***

REINIGUNGSPADS

11D

SUPER-PAD

410x20 mm



Artikel-Nr. <i>article-no.</i>	Beschreibung <i>description</i>	Farbe <i>colour</i>	VE <i>unit</i>	Preis/Stück <i>price/piece</i>	
				Lagerware	Bestellware
441240	zum Polieren, Hochglanz und Pflege	weiß/ <i>white</i>	5	10,09	
441235	zur Pflege für Kunststoff und Holz, Ölen	beige/ <i>beige</i>	5	9,68	
441230	Unterhaltsreinigung, leichte Verschmutzung	rot/ <i>red</i>	5	9,68	
441225	zur Pflege für Kunststoff und Steinböden	grün/ <i>green</i>	5	9,68	
441220	für Grundreinigung, sehr starker Abrieb	schwarz/ <i>black</i>	5	9,68	

NORMAL-PAD

410x10 mm

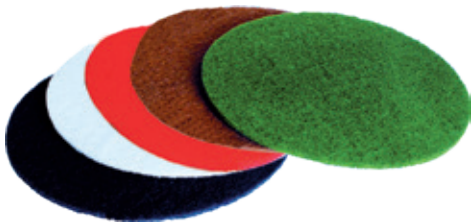

Artikel-Nr. <i>article-no.</i>	Beschreibung <i>description</i>	Farbe <i>colour</i>	VE <i>unit</i>	Preis/Stück <i>price/piece</i>	
				Lagerware	Bestellware
137100000	zum Polieren, Hochglanz und Pflege	weiß/ <i>white</i>	10	4,35	
137100200	zur Pflege für Kunststoff und Holz, Ölen	beige/ <i>beige</i>	10	4,35	
137100400	Unterhaltsreinigung, leichte Verschmutzung	rot/ <i>red</i>	10	4,35	
137100600	zur Pflege für Kunststoff und Steinböden	grün/ <i>green</i>	10	4,35	
137100800	für Grundreinigung, sehr starker Abrieb	schwarz/ <i>black</i>	10	4,35	

PINSELN

LASUR PINSEL STÄRKE 9 mit Holzgriff



Artikel-Nr. <i>article-no.</i>	Material <i>material</i>	Maß <i>size</i>	VE <i>unit</i>	Preis/Stück <i>price/piece</i>
F8934130	Stärke 9	30 mm	12	3,55
F8934140	Stärke 9	40 mm	12	4,66
F8934150	Stärke 9	50 mm	12	5,96
F8934160	Stärke 9	60 mm	12	7,82

Lagerware	Bestellware

MALER-LACKIER-PINSEL rostfrei mit Holzgriff



Artikel-Nr. <i>article-no.</i>	Material <i>material</i>	Maß <i>size</i>	VE <i>unit</i>	Preis/Stück <i>price/piece</i>
F8938730		30 mm	12	3,39
F8938740		40 mm	12	4,10
F8938750		50 mm	12	5,43
F8938760		60 mm	12	6,35

Lagerware	Bestellware

FLACHPINSEL GELB mit Kunststoffgriff



Artikel-Nr. <i>article-no.</i>	Material <i>material</i>	Maß <i>size</i>	VE <i>unit</i>	Preis/Stück <i>price/piece</i>
850150		50 mm	12	2,36

Lagerware	Bestellware



**SPACHTELN
ZAHNSPACHTELN
ZAHNLEISTEN
MUTTERSACHTELN**

***SCRAPERS
ADHESIVE SPREADERS
NOTCHED BLADES
MASTER PUTTY KNIVES***

SPACHTELN

11F

MALERSPACHTEL
mit Holzgriff
PAINTER'S PUTTY KNIFE



Artikel-Nr. article-no.	Material material	Maß size	VE unit	Preis/Stück price/piece
100484		40 mm	12	3,78
100486		60 mm	12	4,43
100488		80 mm	12	6,00
100490		100 mm	12	7,27

Lagerware	Bestellware

STUKKATEURSPACHTEL
rostfrei mit Holzgriff
STUCCO PUTTY KNIFE



Artikel-Nr. article-no.	Material material	Maß size	VE unit	Preis/Stück price/piece
109606		60 mm	10	6,71
109608		80 mm	10	7,11
109610		100 mm	10	7,71
109612		120 mm	10	

Lagerware	Bestellware
	8,53

STUKKATEURSPACHTEL
rostfrei mit Kunststoffgriff - Softgriff
STUCCO PUTTY KNIFE



Artikel-Nr. article-no.	Material material	Maß size	VE unit	Preis/Stück price/piece
111006		60 mm	10	8,13
111008		80 mm	10	8,76
111010		100 mm	10	9,34
111012		120 mm	10	10,18

Lagerware	Bestellware

GLÄTTEKELLE
rostfrei mit Edelstahlblatt
SMOOTHING TROWEL



Artikel-Nr. article-no.	Material material	Maß size	VE unit	Preis/Stück price/piece
107150		280x130x7 mm	1	14,82

Lagerware	Bestellware

FLÄCHENSPACHTEL - glatt
mit Holzgriff-elastische Klinge
SURFACE SPATULA



Artikel-Nr. article-no.	Material material	Maß size	VE unit	Preis/Stück price/piece
101720		200 mm	6	3,53
101730		300 mm	6	4,51

Lagerware	Bestellware

FLÄCHENSPACHTEL
rostfrei, elastische Klinge
SURFACE SPATULA



Artikel-Nr. article-no.	Material material	Maß size	VE unit	Preis/Stück price/piece
101925		250 mm	1	9,13
101940		400 mm	1	11,75

Lagerware	Bestellware

JAPANSPACHTEL-SET 4 teilig
JAPANESE PUTTY KNIFE-SET



Artikel-Nr. article-no.	Material material	Maß size	VE unit	Preis/Stück price/piece
101000		50/80/105/120 mm	1	4,93

Lagerware	Bestellware

PROFI-ZAHNSPACHTELN

PROFIZAHNSPACHTEL 180 mm

Adhesive spreader professional



Artikel-Nr. article-no.	Zahnung	Einsatz für application for	Maß size	VE unit	Preis/Stück price/piece
400019	A1	PVC, Design, CV-Beläge	180 mm	6	4,39
400020	A2	PVC, Design, Lino, Kautschukbelag	180 mm	6	4,39
400022	A3	für Klebe und Spachtelmassen	180 mm	6	4,39
400018	B1	Textile Bodenbeläge, Linoleum	180 mm	6	4,39
400017	B2	Nadelvlies mit groben Rücken	180 mm	6	4,39
400021	B3	Massivparkett	180 mm	6	4,39
400024	B4	für Klebstoffe	180 mm	6	4,39
400048	B11	Parkett, Dielen	180 mm	6	4,39
400056	B15	Holzpflaster, Massivdielen	180 mm	6	4,39
400025	C1	für Klebstoffe	180 mm	6	4,39

Lagerware	Bestellware

11F

PROFIZAHNSPACHTEL 280 mm

Adhesive spreader professional



Artikel-Nr. article-no.	Zahnung	Einsatz für application for	Maß size	VE unit	Preis/Stück price/piece
400029	A1	PVC, Design, CV-Beläge	280 mm	6	6,02
400030	A2	PVC, Design, Lino, Kautschukbelag	280 mm	6	6,02
400038	A3	für Klebe und Spachtelmassen	280 mm	6	6,02
400028	B1	Textile Bodenbeläge, Linoleum	280 mm	6	6,02
400037	B2	Nadelvlies mit groben Rücken	280 mm	6	6,02
400031	B3	Massivparkett	280 mm	6	6,02
400032	B4	für Klebstoffe	280 mm	6	6,02
400084	B12	für Tafel- und Mehrschichtparkett	280 mm	6	6,02
400086	B15	Holzpflaster, Massivdielen	280 mm	6	6,02
400033	C1	für Klebstoffe	280 mm	6	6,02

Lagerware	Bestellware

A Feinzahnung

Bezeichnung:

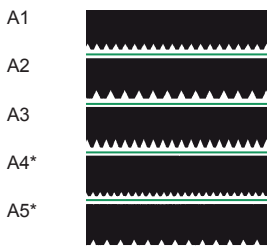

B Grob Zahnung

Bezeichnung:

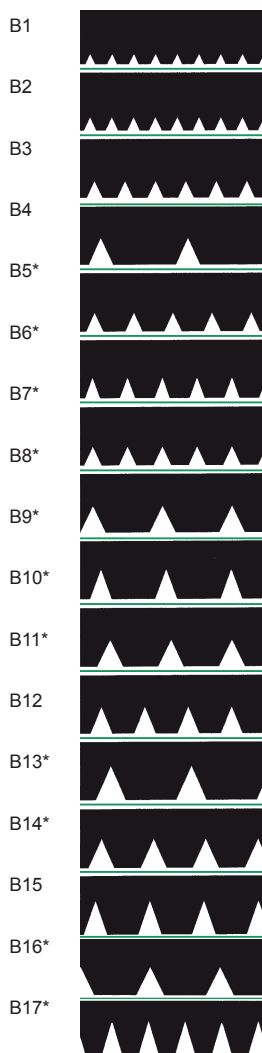

C Grob Zahnung

Bezeichnung:

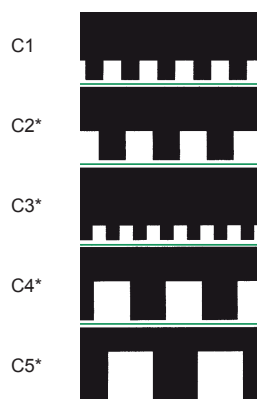

Spezialzahnung

Bezeichnung:

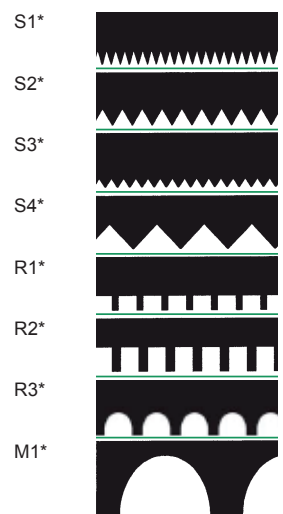

* BESTELLWARE / order article

MUTTERSPACHTELN

11F

MUTTERSPACHTEL
inklusive auswechselbarer Zahnleiste B2 (Seite 183)
180 mm

Adhesive spreader professional holder

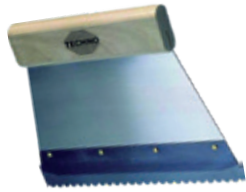

Artikel-Nr.
article-no.

400118

Beschreibung
description

Maß
size

180 mm

VE
unit

6

Preis/Stück
price/piece

Lagerware	Bestellware
7,92	

MUTTERSPACHTEL
inklusive auswechselbarer Zahnleiste B2 (Seite 183)
180 mm

Adhesive spreader professional holder



Artikel-Nr.
article-no.

243451800

Beschreibung
description

antihafbeschichtet - Teflon

Maß
size

180 mm

VE
unit

4

Preis/Stück
price/piece

Lagerware	Bestellware
71,04	

MUTTERSPACHTEL
inklusive auswechselbarer Zahnleiste B2 (Seite 183)
280 mm

Adhesive spreader professional holder

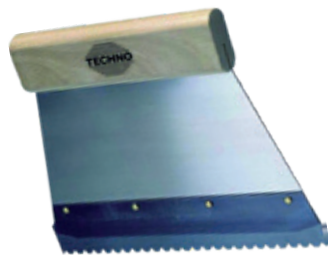

Artikel-Nr.
article-no.

400128

Beschreibung
description

Maß
size

280 mm

VE
unit

6

Preis/Stück
price/piece

Lagerware	Bestellware
11,58	

MUTTERSPACHTEL
inklusive auswechselbarer Zahnleiste B2 (Seite 183)
280 mm

Adhesive spreader professional holder



Artikel-Nr.
article-no.

243452800

Beschreibung
description

antihafbeschichtet - Teflon

Maß
size

280 mm

VE
unit

4

Preis/Stück
price/piece

Lagerware	Bestellware
82,87	

ZAHNLEISTEN

ZAHNLEISTEN für Mutterspachtel (Seite 182)

180 mm

Blister = 10 Klingen

Adhesive spreader



Artikel-Nr. article-no.	Zahnung	Beschreibung description	Maß size	VE/Blister unit/blister	Preis/Blister price/blister
400211	A1		180 mm	1	14,23
400212	A2		180 mm	1	14,15
400221	B1		180 mm	1	15,26
400222	B2		180 mm	1	13,19
400223	B3		180 mm	1	13,19
400225	B5		180 mm	1	13,19
400248	B11		180 mm	1	15,26
400231	C1		180 mm	1	8,86
400232	C2		180 mm	1	9,11
400233	C3		180 mm	1	13,19

Lagerware	Bestellware
14,23	
14,15	
15,26	
13,19	
13,19	13,19
15,26	
8,86	
9,11	
13,19	

11F

ZAHNLEISTE für Mutterspachtel (Seite 182)

280 mm

Blister = 10 Klingen

Adhesive spreader

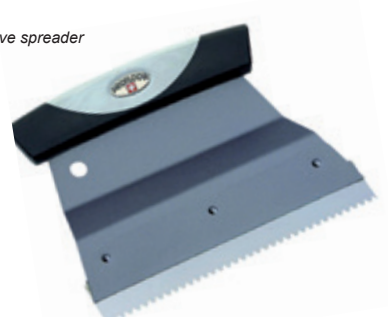

Artikel-Nr. article-no.	Zahnung	Beschreibung description	Maß size	VE/Blister unit/blister	Preis/Blister price/blister
400311	A1		280 mm	1	15,38
400312	A2		280 mm	1	15,26
400313	A3		280 mm	1	16,76
400315	A5		280 mm	1	17,14
400321	B1		280 mm	1	15,99
400322	B2		280 mm	1	16,26
400323	B3		280 mm	1	17,14
400330	B11		280 mm	1	16,26
400331	C1		280 mm	1	14,23
400332	C2		280 mm	1	19,29

Lagerware	Bestellware
15,38	
15,26	
16,76	
17,14	17,14
15,99	
16,26	
17,14	
16,26	
14,23	
19,29	

A Feinzahnung

Bezeichnung:

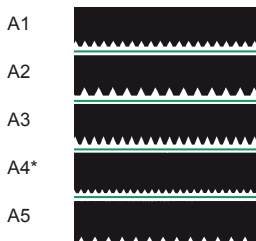

B Grob Zahnung

Bezeichnung:

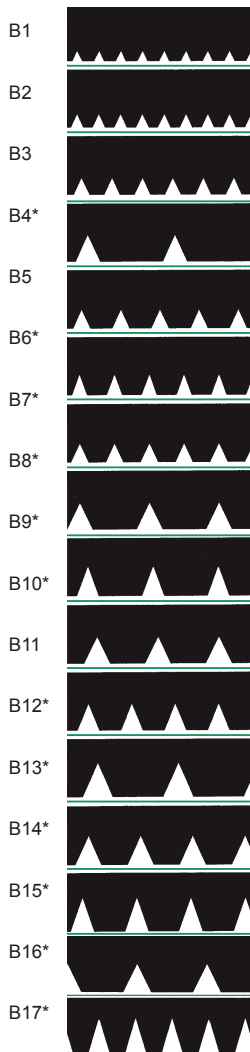

C Grob Zahnung

Bezeichnung:

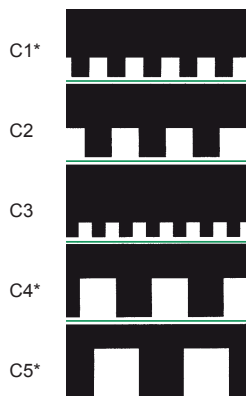

Spezialzahnung

Bezeichnung:

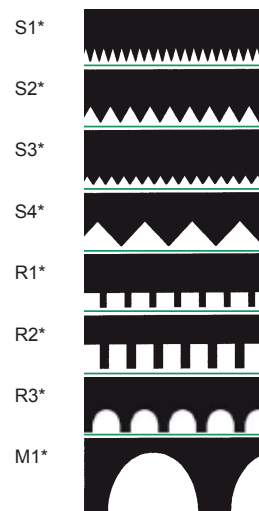

* BESTELLWARE / order article



**ROLLMASSBAND
DIVERSE WERKZEUGE**

***POCKET STEEL TAPE
VARIOUS TOOLS***

ROLLMETER

11G
11H

ROLLMASSBAND knickstabiles, lackiertes Stahlband

Pocket steel tape



Artikel-Nr. article-no.	Maß size	VE unit	Preis/Stück price/piece
140203	3 m	1	4,35
140205	5 m	1	6,79
140208	8 m	1	10,53

DIVERSE WERKZEUGE

FEINSTAUBMASKE P1 Schutz bis 4-fachen MAK-Wert Filtering mask P1



Artikel-Nr. article-no.	VE unit	Preis/Stück price/piece
160800	10	1,99

FEINSTAUBMASKE P2S Schutz bis 10-fachen MAK-Wert Filtering mask P2S



Artikel-Nr. article-no.	VE unit	Preis/Stück price/piece
160801	10	3,26

SCHLAGSCHNURFÄRBER 30 Meter Schnurschutz-Hülse / Metallkurbel Chalk line reel



Artikel-Nr. article-no.	VE unit	Preis/Stück price/piece
138600	3	17,49

FARBPULVER SCHLAGSCHNURFÄRBER für/for Artikel 138600 Chalk powder



Artikel-Nr. article-no.	Material material	Gewicht weight	VE unit	Preis/Stück price/piece
138351	rot	113 g	6	4,47
138352	blau	113 g	6	4,47

PROFI-SKELETTPISTOLE geeignet für 320 ml Standard mit Fugenfux Caulking gun / Skeleton 320 ml



Artikel-Nr. article-no.	VE unit	Preis/Stück price/piece
116100	12	26,65

DIVERSE WERKZEUGE

KLEBESPRITZE PROFESSIONAL

Nadeln in 3 verschiedenen Stärken

Glue syringe professional

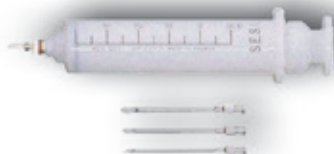

Artikel-Nr.
article-no.

319205

VE
unit

1

Preis/Stück
price/piece

Lagerware	Bestellware
74,55	

11A

ALUMINIUM-REISSKLAUE

zum Entfernen verklebter Bodenbläge

Aluminium carpet-removing claw



Artikel-Nr.
article-no.

418700

VE
unit

1

Preis/Stück
price/piece

Lagerware	Bestellware
59,19	

PARKETTZUGEISEN PROFESSIONAL

Ambosse mit Schlagschutzkappe

Heavy-duty pulling iron



Artikel-Nr.
article-no.

418843

VE
unit

1

Preis/Stück
price/piece

Lagerware	Bestellware
56,45	

TASCHEN-SÄGEBOGEN PUK

Ambosse mit Schlagschutzkappe

Sägeblatt = 147 mm

Pocket utility-saw PUK



Artikel-Nr.
article-no.

185300

VE
unit

1

Preis/Stück
price/piece

Lagerware	Bestellware
18,94	

KUPFERLEITBAND

selbstklebend

Copper contactible ribbon, self adhesive

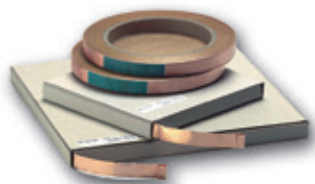

Artikel-Nr.
article-no.

441502

Maß
size

Blister=3 x 20 m Rolle

VE/Blister
unit/blister

20

Preis/Blister
price/blister

Lagerware	Bestellware
36,14	

DIVERSE WERKZEUG

11H

DIY VERLEGESET 22-teilig
 Zugeisen, Schlagklotz, Keile, usw.....
 DIY-Installation kit



Artikel-Nr. article-no.	VE/Set unit/set	Preis/Set price/set				
437140	20	<table border="1"> <tr> <th>Lagerware</th> <th>Bestellware</th> </tr> <tr> <td>17,43</td> <td></td> </tr> </table>	Lagerware	Bestellware	17,43	
Lagerware	Bestellware					
17,43						

VERLEGEKEILE SET 20-teilig
 Installation wedges



Artikel-Nr. article-no.	VE/Blister unit/blister	Preis/Blister price/blister				
437120	20	<table border="1"> <tr> <th>Lagerware</th> <th>Bestellware</th> </tr> <tr> <td>4,91</td> <td></td> </tr> </table>	Lagerware	Bestellware	4,91	
Lagerware	Bestellware					
4,91						

HEISSKLEBPISTOLE GETRA 325
 für dm=18 mm Sticks
 Temperatur verstellbar
 600 Watt
 HOT GLUE GUN



Artikel-Nr. article-no.	VE unit	Preis/Stück price/piece				
GETRA 325	1	<table border="1"> <tr> <th>Lagerware</th> <th>Bestellware</th> </tr> <tr> <td>449,35</td> <td></td> </tr> </table>	Lagerware	Bestellware	449,35	
Lagerware	Bestellware					
449,35						

HEISSSCHMELZKLEBER für GETRA 325
 dm=18 mm
 HOT GLUE



Artikel-Nr. article-no.	Maß size	Gewicht size	VE unit	Preis/Karton price				
A30158	18 x 300 mm	10 kg	1	<table border="1"> <tr> <th>Lagerware</th> <th>Bestellware</th> </tr> <tr> <td>217,05</td> <td></td> </tr> </table>	Lagerware	Bestellware	217,05	
Lagerware	Bestellware							
217,05								



**MÜLLSÄCKE
REINIGUNG und PFLEGE**

**WASTE BAGS
CLEANING and CARE**

MÜLLSÄCKE

PE-GEWERBEMÜLLSACK

110 l - 40µm - 1 Rolle=10 Stück

PE WASTE BAG
1 roll = 10 pieces



Artikel-Nr.
article-no.

Maß
size

VE/Rolle
unit/roll

Preis/Rolle
price/roll

MS 110 71x110 cm

20

Lagerware	Bestellware
4,64	

PE-GEWERBEMÜLLSACK

110 l - 70µm - 1 Rolle=10 Stück

PE WASTE BAG
1 roll = 10 pieces



Artikel-Nr.
article-no.

Maß
size

VE/Rolle
unit/roll

Preis/Rolle
price/roll

MS 115 70x110 cm

10

Lagerware	Bestellware
7,27	

PE-GEWERBEMÜLLSACK

200 l - 60µm - 1 Rolle=10 Stück

PE WASTE BAG
1 roll = 10 pieces



Artikel-Nr.
article-no.

Maß
size

VE/Rolle
unit/roll

Preis/Rolle
price/roll

MS 200 80x120 cm

10

Lagerware	Bestellware
7,27	

PE-BAUSCHUTTSACK

45 l - 160µm - 1 Rolle=10 Stück

PE RUBBLE SACK
1 roll = 10 pieces



Artikel-Nr.
article-no.

Maß
size

VE/Rolle
unit/roll

Preis/Rolle
price/roll

MS BAU 45x90 cm

20

Lagerware	Bestellware
9,82	

SACK-BUTLER für jede Größe

SACK-BUTLER for each size



Artikel-Nr.
article-no.

VE
unit

Preis/Stück
price/piece

18888 00

1

Lagerware	Bestellware
27,19	

REINIGUNG und PFLEGE

REINIGUNGSTÜCHER

zur Entfernung von Kleberesten

Faserverstärkte, speziell imprägnierte Tücher mit Zitrusduft

CLEANING TISSUES



Artikel-Nr.
article-no.

Beschreibung
disciption

VE
unit

Preis/Kübel
price/piece

RT5960 150 Stück

1

Lagerware	Bestellware
72,84	



**BOLTA
HARTSCHAUMSOCKELLEISTE**

***BOLTA
HARD FOAM SKIRTING BOARD***

BOLTA KUBISCHE HART-SCHAUM SOCKELLEISTE - stanzbar

12A

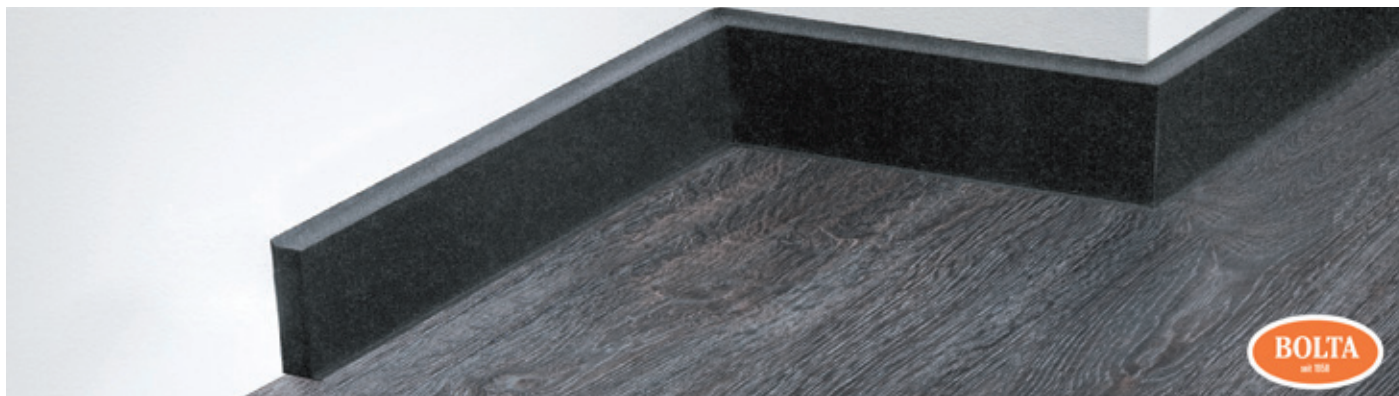

Q12 kubische Hartschaumsockelleiste 60 mm mit durchgefärbter Deck- und Bodenlippe

- PVC Hartschaumsockelleiste in 60 mm Bauhöhe
- feuchtigkeitsunempfindlich und formstabil
- **genarbte** Oberfläche

HARTSCHAUMSOCKELLEISTE 60 mm

Hard foam skirting board
60x12 mm

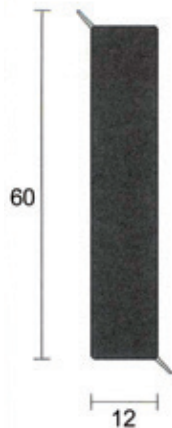

Artikel-Nr. article-no.	Farbe colour	VE unit
10650Q 101	weiß	50 m
10650Q 107	grau	50 m
10650Q 1236	hellgrau	50 m
10650Q 7043	basalt	50 m

Preis/Stange price/piece	
250 cm	250 cm
Lagerware	Bestellware
	15,70
	15,70
	15,70
	15,70

**FARBTABELLE
Colour Card**

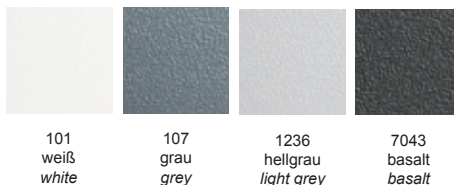

- PVC Hartschaumsockelleiste in 60 mm Bauhöhe
- feuchtigkeitsunempfindlich und formstabil
- **glatte** Oberfläche

HARTSCHAUMSOCKELLEISTE 60 mm

Hard foam skirting board
60x12 mm

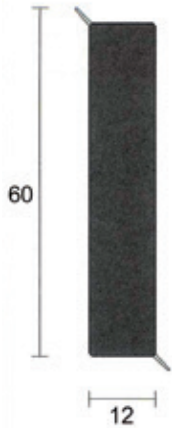

Artikel-Nr. article-no.	Farbe colour	VE unit
10655Q 101	weiß	50 m
10655Q 107	grau	50 m
10655Q 1236	hellgrau	50 m
10655Q 7043	basalt	50 m

Preis/Stange price/piece	
250 cm	250 cm
Lagerware	Bestellware
	15,70
	15,70
	15,70
	15,70

**FARBTABELLE
Colour Card**

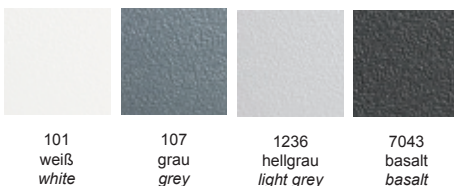

Verlegehinweis



Montagekleber



BOLTA-Stanze



Nägel

BOLTA HART-SCHAUM SOCKELLEISTE - stanzbar

12A



Hart-Schaum-Sockelleiste 60 mm mit durchgefärbter Deck- und Bodenlippe - 250 cm

HARTSCHAUMSOCKELLEISTE 60 mm

Hard foam skirting board

60x12,8 mm

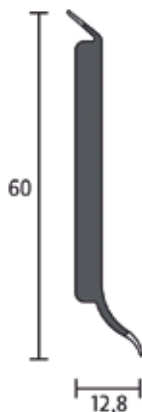

Artikel-Nr. article-no.	Farbe colour	VE unit
25560 101	weiß	100 m
25560 107	grau	100 m
25560 272	hellbeige	100 m
25560 1168	eisweiß	100 m
25560 1236	hellgrau	100 m
25560 1594	schwarz	100 m
25560 8538	eiche	100 m
25560 8619	buche select	100 m
25560 8628	wildkirsche	100 m
25560 8661	buche	100 m
25560 8662	ahorn	100 m
25560 8695	wenge	100 m
25560 8702	nussbaum dunkel	100 m
25560 8740	silber	100 m

Preis/Stange price/piece	
250 cm	250 cm
Lagerware	Bestellware
10,30	
10,30	
10,30	
10,30	
10,30	
10,30	
10,30	
	10,30
	10,30
10,30	
	10,30
	10,30
10,30	
10,30	

**FARBTABELLE
Colour Card**



Verlegehinweis



Montagekleber



BOLTA-Stanze



Kleband

BOLTA HART-SCHAUM SOCKELLEISTE - stanzbar

12A



Hart-Schaum-Sockelleiste 60 mm mit durchgefärbter Deck- und Bodenlippe - 400 cm

HARTSCHAUMSOCKELLEISTE 60 mm

Hard foam skirting board
60x12,8 mm

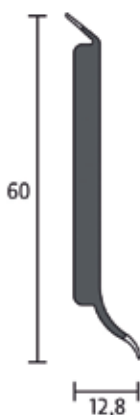

Artikel-Nr. article-no.	Farbe colour	VE unit	Preis/Stange price/piece	
			400 cm Lagerware	400 cm Bestellware
10560 101	weiß	100 m	16,47	
10560 272	hellbeige	100 m		16,47
10560 295	beige	100 m		16,47
10560 0107	grau	100 m	16,47	
10560 0525	braun	100 m		16,47
10560 1168	eisweiß	100 m	16,47	
10560 1236	hellgrau	100 m	16,47	
10560 1587	weißgrau	100 m		16,47
10560 1594	schwarz	100 m		16,47
10560 5289	espresso	100 m		16,47
10560 7043	basalt	100 m		16,47
10560 8538	eiche	100 m	16,47	
10560 8619	buche select	100 m		16,47
10560 8628	wildkirsche	100 m		16,47
10560 8661	buche	100 m		16,47
10560 8662	ahorn	100 m		16,47
10560 8695	wenge	100 m		16,47
10560 8699	kiefer	100 m		16,47
10560 8702	nußbaum	100 m		16,47
10560 8703	buche rustic	100 m		16,47
10560 8740	silber	100 m		16,47
10560 8824	platane	100 m	16,47	
10560 8829	wildbirne	100 m		16,47

**FARBTABELLE
Colour Card**

101 weiß white	272 hellbeige light beige	295 beige beige	0107 grau grey	0525 braun brown	1168 eisweiß icewhite	1236 hellgrau light grey
1587 weißgrau whitegrey	1594 schwarz black	5289 espresso espresso	7043 basalt basalt	8538 eiche oak	8619 buche select beech select	8628 wildkirsche wild cherry
8661 buche beech	8662 ahorn maple	8695 wenge wenge	8699 kiefer pine	8702 nußbaum walnut tree	8703 buche rustic beech rustic	8740 silber silver
8824 platane plane	8829 wildbirne wild pear					

Verlegehinweis

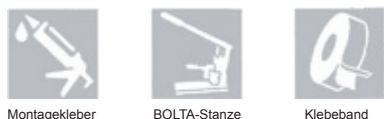

BOLTA HARTSCHAUMSOCKELLEISTE



Hartschaumsockelleiste 80 mm mit durchgefärbter Weichlippe am Boden

- + PVC Hartschaumsockelleiste in 80 mm Bauhöhe
- + feuchtigkeitsunempfindlich
- + flexible **durchgefärbte** Weichlippe am Bodenanschluss

HARTSCHAUMSOCKELLEISTE 80 mm

Hard foam skirting board
80x15 mm

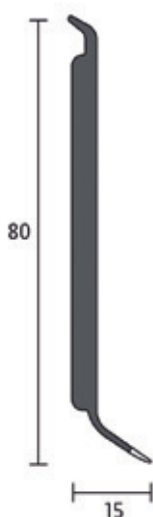

Artikel-Nr. article-no.	Farbe colour	VE unit
10575 101	weiß	100 m
10575 107	grau	100 m

Preis/Stange price/piece	
400 cm Lagerware	400 cm Bestellware
25,41	
25,41	

FARBTABELLE Colour Card

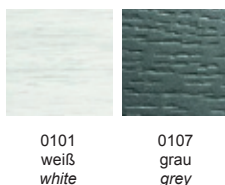

Verlegehinweis



Montagekleber



BOLTA-Stanze



Klebeband

KERBSTANZE für BOLTA Leisten

BOLTA skirting board punch



Artikel-Nr. article-no.	Farbe colour	VE unit
B KERBSTANZE		1

Preis/Stück price/piece	
Lagerware	Bestellware
	459,80



**BOLTA
HARTSCHAUMSOCKELLEISTE
DESIGN**

***BOLTA
HARD FOAM SKIRTING BOARD
DESIGN***

BOLTA HARTSCHAUMSOCKELLEISTE

12A



Hartschaumsockelleiste 60 mm mit transparenter Deck- und Bodenlippe

HARTSCHAUMSOCKELLEISTE 60 mm

Hard foam skirting board
60x12,8 mm

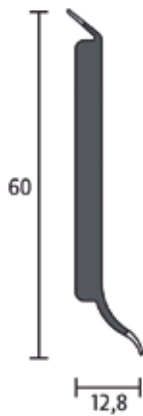

Artikel-Nr. article-no.	Farbe colour	VE unit
25560 8735	eiche rustikal	100 m
25560 8743	schoko, wenge	100 m
25560 8747	paduk	100 m
25560 8748	kastanie	100 m
25560 8749	meereiche	100 m
25560 8778	tanne antik	100 m
25560 8806	sitka fichte	100 m
25560 8807	landhaus	100 m
25560 9101	weiß	100 m

Preis/Stange price/piece	
250 cm	250 cm
Lagerware	Bestellware
10,30	
10,30	
10,30	
10,30	
10,30	
10,30	
10,30	
10,30	10,30
10,30	

FARBTABELLE Colour Card

8735 eiche rustikal <i>oak rustic</i>	8743 schoko <i>choco</i>	8747 paduk <i>paduk</i>	8748 kastanie <i>chestnut</i>	8749 meereiche <i>sea oak</i>
8778 tanne antik <i>fir antique</i>	8806 sitka fichte <i>sitka spruce</i>	8807 landhaus <i>landhouse</i>	9101 weiß <i>white</i>	

Verlegehinweis



Montagekleber



BOLTA-Stanze



Klebeband

BOLTA HARTSCHAUMSOCKELLEISTE für Designbeläge



12B

Hartschaumsockelleiste 58 mm mit transparenter Weichlippe am Boden - 250 cm

- + PVC Hartschaumplankenprofil in 58 mm Bauhöhe
- + feuchtigkeitsunempfindlich und formstabil
- + zum Einkleben von Bodenbelagsstreifen
- + Schattenfuge oben, **transparente** Weichlippe am Boden

HARTSCHAUMSOCKELLEISTE

Hard foam skirting board

58x11,8 mm

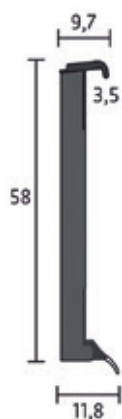

Artikel-Nr. article-no.	Farbe colour	VE unit
25669 101	weiß	100 m
25669 107	grau	100 m
25669 272	beige	100 m
25669 865	silber	100 m
25669 880	champagner	100 m
25669 899	bronze	100 m
25669 1594	schwarz	100 m
25669 5309	mocca	100 m

Preis/Stange price/piece	
250 cm	250 cm
Lagerware	Bestellware
12,50	12,50
12,50	
12,50	
12,50	12,50
	12,50
	12,50
	12,50

FARBTABELLE Colour Card

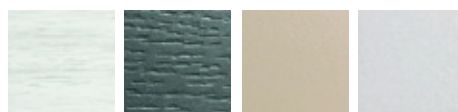

0101
weiß
white

0107
grau
grey

0272
beige
beige

0865
silber
silver



0880
champagner
champagne

0899
bronze
bronze

1594
schwarz
black

5309
mocca
mocca

Verlegehinweis



Montagekleber



BOLTA-Stanze



Kleband

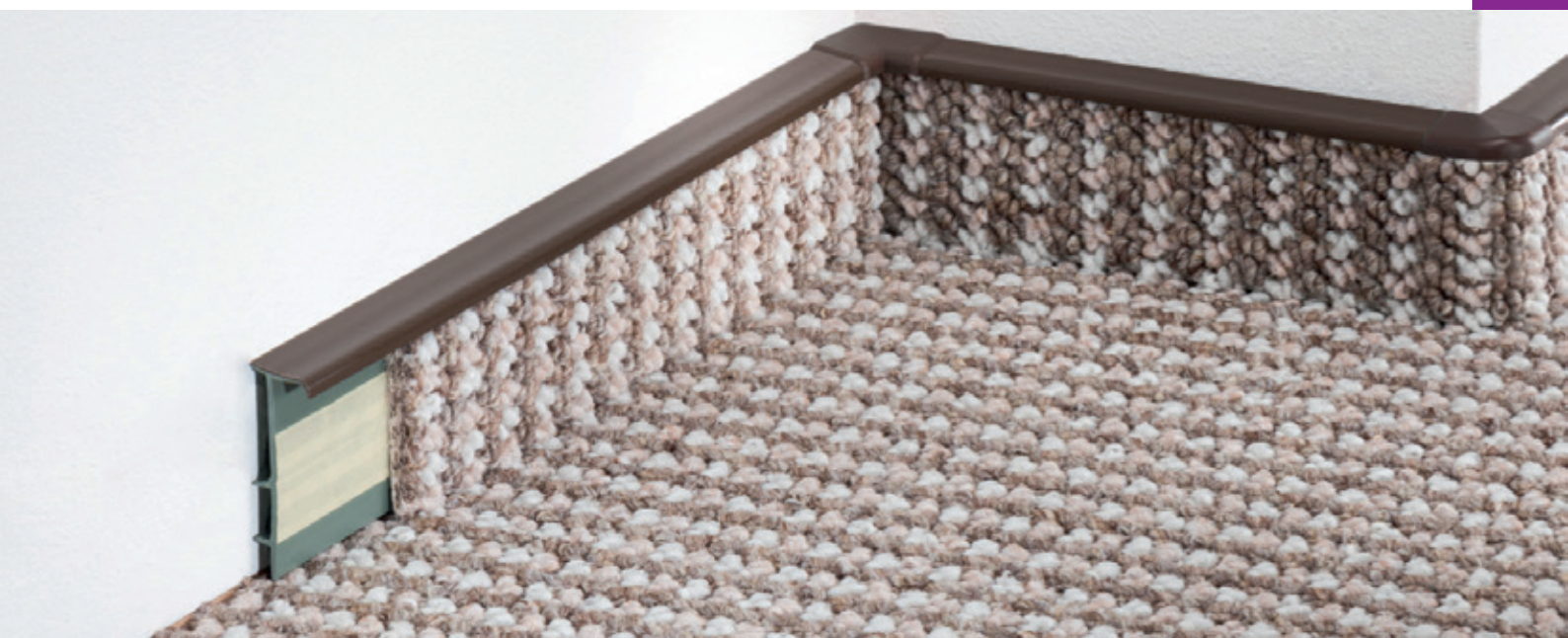

**BOLTA
TEPPICHEINFASSPROFIL**

***BOLTA
CARPET SKIRTING BOARDS***

BOLTA TEPPICHEINFASSPROFIL

12C

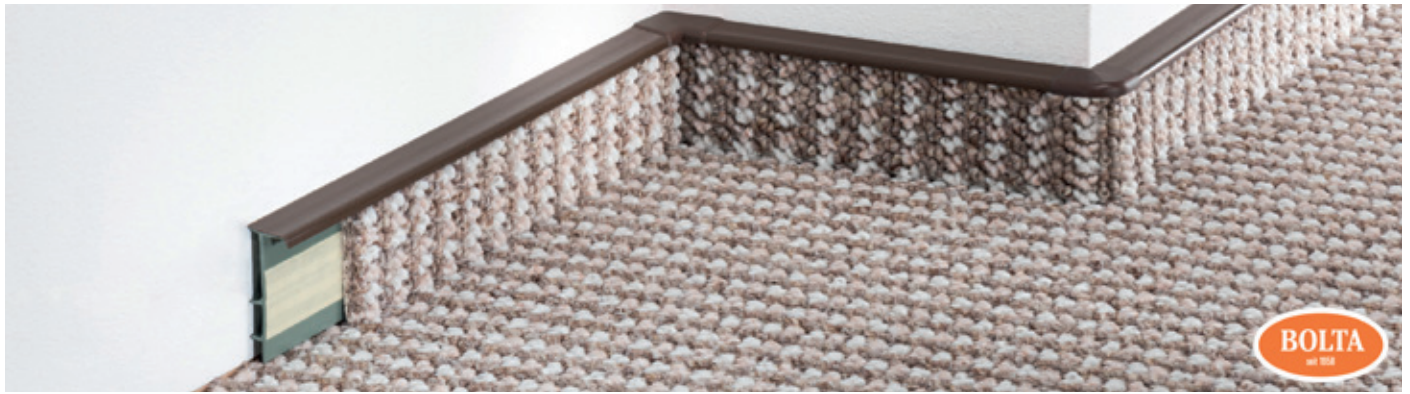

Teppichsockelleiste aus Hart-PVC in 55 mm Bauhöhe mit weichem Dach

+ Einklebbereich ist bereits selbstklebend ausgestattet

Teppicheinfassleiste 9 mm

Carpet skirting board 9 mm
55x9mm

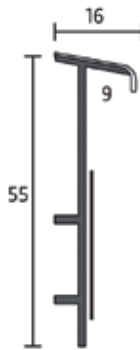

Artikel-Nr. article-no.	Farbe colour	VE unit
----------------------------	-----------------	------------

25482 101	weiß	100 m
-----------	------	-------

Preis/Stange price/piece	
250 cm	250 cm
Lagerware	Bestellware
5,64	

FARBTABELLE Colour Card



0101
weiß
white

Teppicheinfassleiste 6 mm

Carpet skirting board 6 mm
55x6 mm

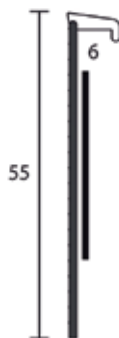

Artikel-Nr. article-no.	Farbe colour	VE unit
----------------------------	-----------------	------------

10387 30	eiche	100 m
10387 101	weiß	100 m
10387 107	grau	100 m
10387 865	silber	100 m
10387 8542	buche	100 m

Preis/Stange price/piece	
400 cm	400 cm
Lagerware	Bestellware
	7,69
7,69	
7,69	
7,69	
	7,69

FARBTABELLE Colour Card



0030
Eiche
oak



0101
weiß
white



0107
grau
grey



0865
silber
silver



8542
Buche
beech



**WEICHKUNSTSTOFFSOCKELLEISTE
SL 50, 70 und 100**

***SOFT PVC SKIRTING
SL 50, 70 and 100***

WEICHKUNSTSTOFFSOCKELLEISTE

12D



SOCKELLEISTE PVC

Skirting PVC
47x18 mm



Artikel-Nr. article-no.	Farbe colour	VE unit	Preis/Rolle price/roll	
			5000 cm Lagerware	5000 cm Bestellware
50 33	anthrazit	50 m	57,48	
50 107	mittelgrau	50 m	57,48	
50 270	hellgraubeige	50 m	57,48	
50 272	mittelgrau	50 m	57,48	
50 275	taupebeige	50 m	57,48	
50 675	graugrün	50 m	57,48	
50 711	hellgraublau	50 m	57,48	
50 712	blau	50 m	57,48	
50 714	blaugrau	50 m	57,48	
50 1236	silbergrau	50 m	57,48	
50 2161	mittelbeige	50 m	57,48	
50 2162	hellbeige	50 m	57,48	
50 2163	gelbbeige	50 m	57,48	
50 D11	dunkelbraun	50 m	57,48	
50 D14	ockerbraun	50 m	57,48	
50 D17	braunbeige	50 m	57,48	
50 E01	weiß	50 m	57,48	
50 E31	eierschale	50 m	57,48	
50 G6	graubeige	50 m	57,48	
50 G10	schwarz	50 m	57,48	
50 G12	hellgrau	50 m	57,48	
50 G21	mittelgrau	50 m	57,48	
50 G22	blaugrau	50 m	57,48	
50 M12	taupe	50 m	57,48	
50 M18	dunkelbeige	50 m	57,48	
50 M20	graubeige	50 m	57,48	
50 M49	saharabeige	50 m	57,48	

SOCKELLEISTE PVC

Skirting PVC
50x15 mm



Artikel-Nr. article-no.	Farbe colour	VE unit	Preis/Rolle price/roll	
			5000 cm Lagerware	5000 cm Bestellware
10510 30	eiche	50 m	59,57	
10510 31	nussbaum	50 m	59,57	
10510 42	buche	50 m	59,57	
10510 74	perlgrau	100 m		59,57

SOCKELLEISTE PVC

Skirting PVC

70x18 mm

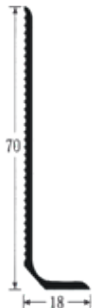

Artikel-Nr. article-no.	Farbe colour	VE unit
70 SL 33	anthrazit	50 m
70 SL 272	mittelgrau	50 m
70 SL D11	dunkelbraun	50 m
70 SL G6	graubeige	50 m
70 SL G10	schwarz	50 m
70 SL G12	hellgrau	50 m
70 SL G21	mittelgrau	50 m
70 SL G22	blaugrau	50 m
70 SL M12	taupe	50 m
70 SL M18	dunkelbeige	50 m
70 SL M20	graubeige	50 m
70 SL M49	saharabeige	50 m

Preis/Rolle price/roll	
5000 cm	5000 cm
Lagerware	Bestellware
103,46	
103,46	
103,46	
103,46	
103,46	
103,46	
103,46	
103,46	
103,46	
103,46	
103,46	
103,46	

12D

SOCKELLEISTE PVC

Skirting PVC

100x20 mm



Artikel-Nr. article-no.	Farbe colour	VE unit
100 SL D11	dunkelbraun	50 m
100 SL G10	schwarz	50 m
100 SL G12	hellgrau	50 m
100 SL G21	mittelgrau	50 m
100 SL M12	taupe	50 m
100 SL M18	dunkelbeige	50 m

Preis/Rolle price/roll	
5000 cm	5000 cm
Lagerware	Bestellware
205,87	
205,87	
205,87	
205,87	
205,87	
205,87	

FARBTABELLE für SL 50, SL 70 und SL 100

Colour Card for SL 50, SL 70 and SL 100

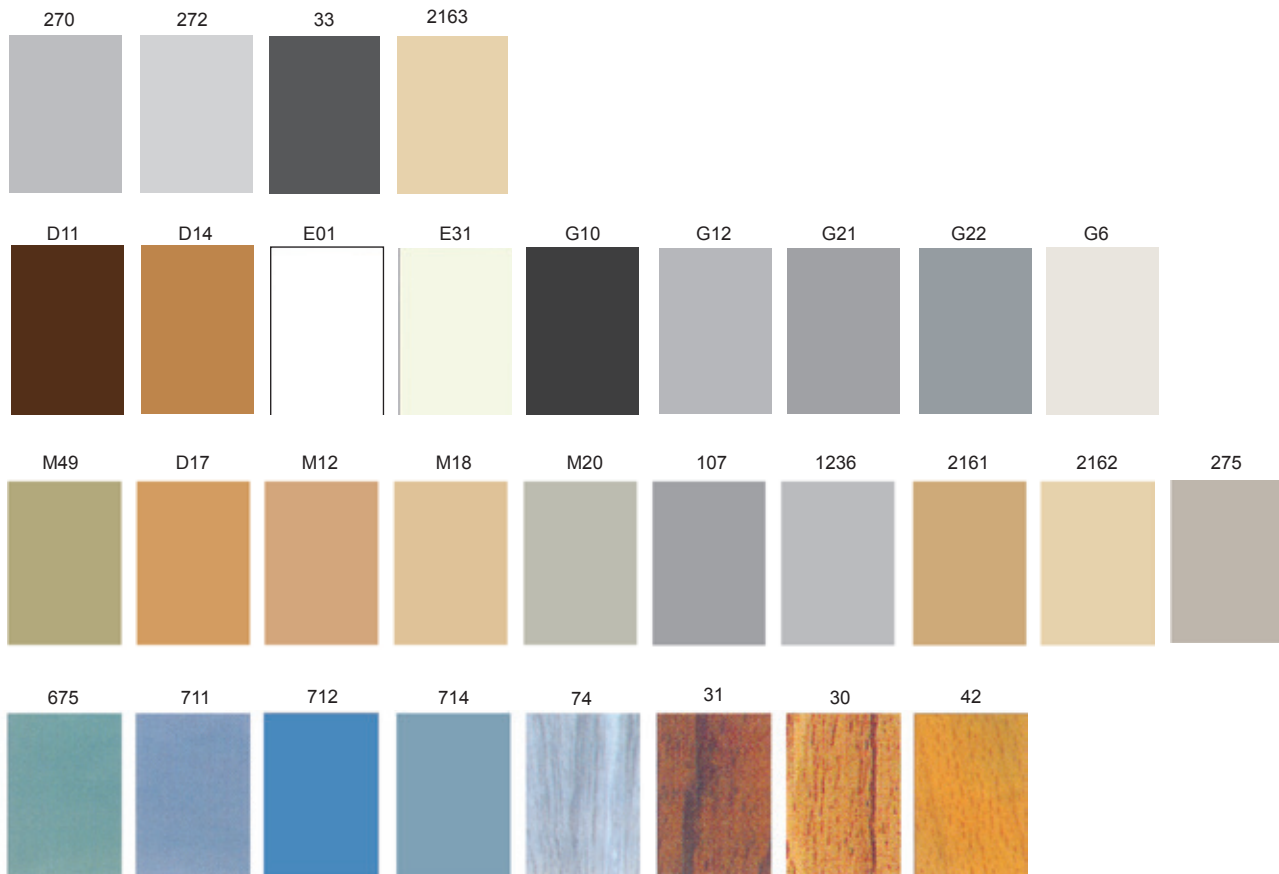

Selbstklebende Kunststoff-Sockelleisten in 5 m
siehe fix-o-moll Programm Seite 245



**CHLOR- u. WEICHMACHERFREIE
WEICHSOCKELLEISTE
WL 50 LIFE**

CHLOR- u. WEICHMACHERFREIE KUNSTSTOFFSOCKELLEISTE

12E



WL 50 life - Aus elastischen, chlorfreiem Polyblend auf Basis EVA-PE (sämtliche Inhaltsstoffe sind REACH-konform) chlor- und weichmacherfreie Weichsockelleiste - schnell und sicher zu montieren mit Switch-Tec Trockenkleber Pomur 6500 4650

WL 50 LIFE

50x15 mm

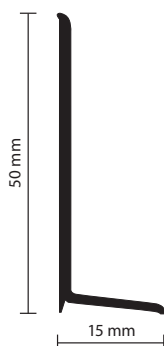

Artikel-Nr. article-no.	Farbe colour	VE unit
WL50 660	buche hell	50 m
WL50 110	schwarz	50 m
WL50 117	weiß	50 m
WL50 130	beige	50 m
WL50 132	braun	50 m
WL50 138	hellgrau	50 m
WL50 146	dunkelgrau	50 m
WL50 348	anthrazit	50 m
WL50 420	parkett	50 m
WL50 913	hellbeige	50 m

Preis/Rolle price/roll	
5000 cm Lagerware	5000 cm Bestellware
	111,82
	111,82
	111,82
	111,82
	111,82
	111,82
	111,82
	111,82
	111,82
	111,82

- Chlor- und weichmacherfreie Weichsockelleiste
- Systemgarantie für die Befestigung bei Montage mit Pomur 46 gem. Montageanleitung
- Einfache und schnelle Montage durch gute Formbarkeit und perfektes Aufsitzen
- Sehr flexibel auslaufende Lippen an Wand und Boden
- Entspricht den Technischen Regeln für Gefahrenstoffe TRGS 610

FARBTABELLE für WL 50 LIFE Colour Card for WL 50 LIFE

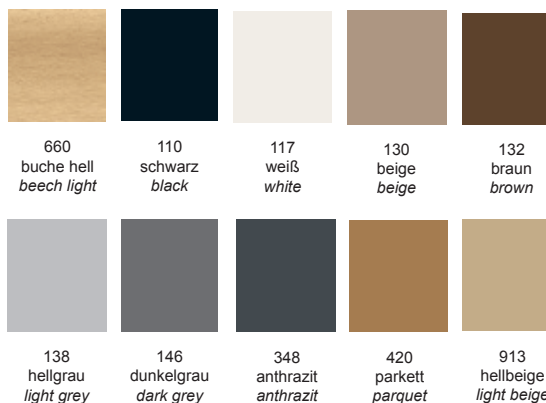

MONTAGE:

Einfach und sicher mit Switch-Tec Pomur Klebeband zu montieren -
siehe Seite 223-POMUR 46

FEUCHTIGKEITSBESTÄNDIGKEIT: 100%

FLEXIBILITÄT:

Folgt allen Unebenheiten der Wand, flexibel auslaufende Lippen an Wand und Boden

DEKORABSTIMMUNG:

Passend zu den gängigen Bodenbelagsdekoren

Höhe: ca. 50 mm
 Randüberdeckung: ca. 15 mm
 Fabrikat: Döllken WL 50 life
 Verlegung: Handwerkergerichte Verarbeitung nach Werkvorschriften, Ecken gut ausformbar, Außenecken gut vorknicken und mit dem Gummihammer formen

Befestigung: Verkleben

Die Befestigung richtet sich nach dem Unterbau der Wand, der auf geeignete Qualität und Festigkeit vom Bodenleger zu prüfen ist. Die Sockelleiste ist unbedingt spannungsfrei zu verlegen. Zur Montage empfehlen wir die Verklebung mit dem perfekt auf die Leiste abgestimmten lösungsmittelfreien Trockenkleber von Switch-Tec, mit dem die TRGS 6010 eingehalten wird.

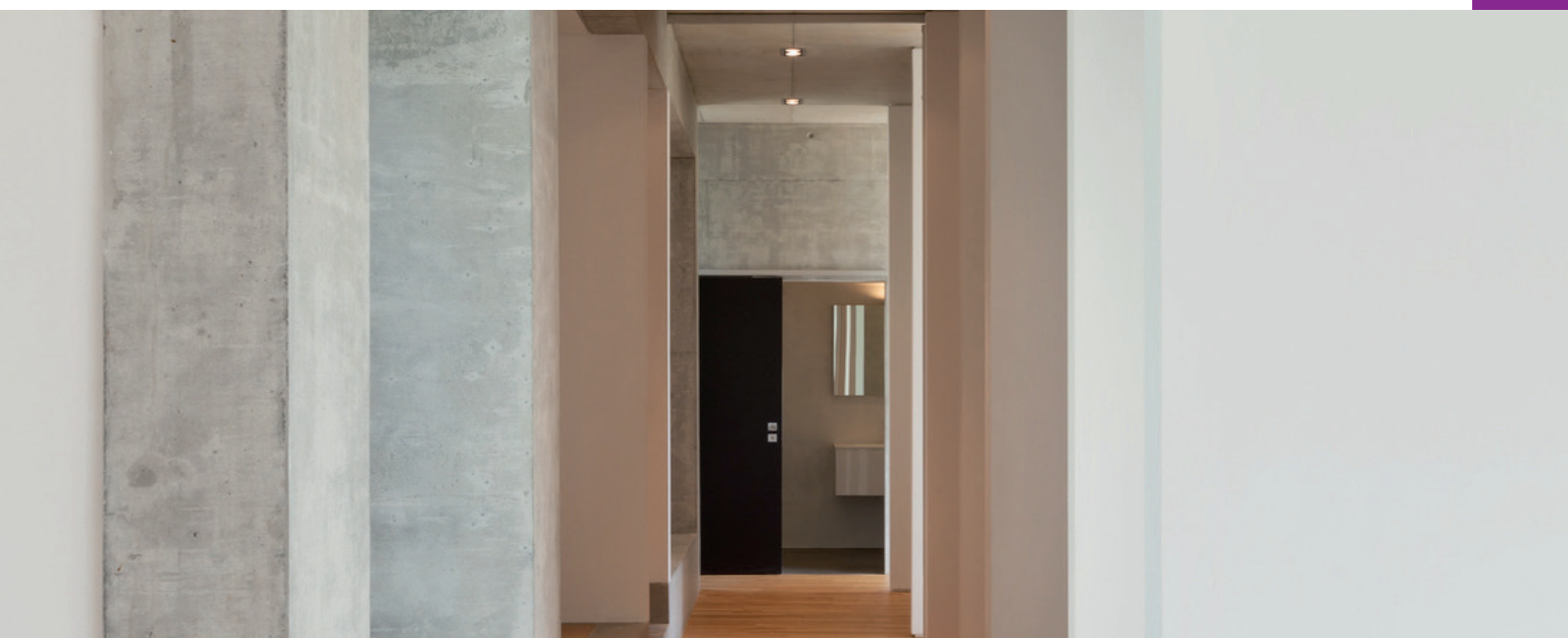

MAUERKANTEN in Kunststoff

WALL CORNERS in PVC

12F

MAUERKANTE
gerillt
Wall corner grooved
25x25 mm x 150 cm
Materialstärke: 2 mm

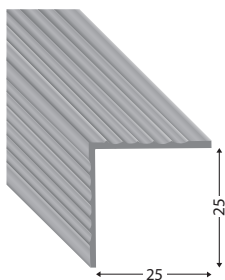

Artikel-Nr. <i>article-no.</i>	Farbe <i>colour</i>	VE <i>unit</i>
25251 WEISS	weiß/ <i>white</i>	20
25251 BEIGE	beige/ <i>beige</i>	20
25251 ELFENB	elfenbein/ <i>ivory</i>	20

Preis/Stück <i>price/piece</i>	
150 cm	150 cm
Lagerware	Bestellware
4,72	
4,72	4,72

MAUERKANTE
gerillt
Wall corner grooved
25x25 mm x 300 cm
Materialstärke: 2 mm

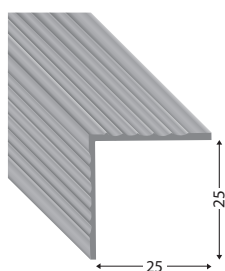

Artikel-Nr. <i>article-no.</i>	Farbe <i>colour</i>	VE <i>unit</i>
2525 WEISS	weiß/ <i>white</i>	10
2525 BEIGE	beige/ <i>beige</i>	10
2525 ELFENB	elfenbein/ <i>ivory</i>	10

Preis/Stange <i>price/piece</i>	
300 cm	300 cm
Lagerware	Bestellware
8,97	
8,97	8,97

MAUERKANTE
gerillt
Wall corner grooved
40x40 mm x 150 cm
Materialstärke: 2 mm

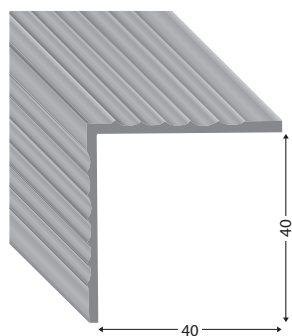

Artikel-Nr. <i>article-no.</i>	Farbe <i>colour</i>	VE <i>unit</i>
40401 WEISS	weiß/ <i>white</i>	20
40401 BEIGE	beige/ <i>beige</i>	20

Preis/Stück <i>price/piece</i>	
150 cm	150 cm
Lagerware	Bestellware
7,32	
7,32	

MAUERKANTE
gerillt
Wall corner grooved
40x40 mm x 300 cm
Materialstärke: 2 mm

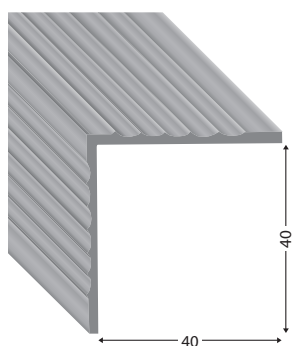

Artikel-Nr. <i>article-no.</i>	Farbe <i>colour</i>	VE <i>unit</i>
4040 WEISS	weiß/ <i>white</i>	10
4040 BEIGE	beige/ <i>beige</i>	10

Preis/Stange <i>price/piece</i>	
300 cm	300 cm
Lagerware	Bestellware
14,30	
14,30	

FARBTABELLE für 2525 und 4040
Colour Card for 2525 and 4040

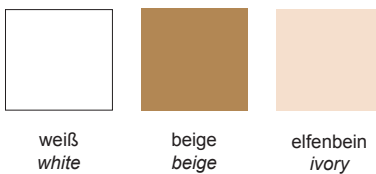



**TREPPENKANTEN und
HOHLKEHLENSTÜTZPROFILE
in Kunststoff**

***STAIR NOSINGS and
COVE FORMERS in PVC***

12G

Treppenkante PVC
Stair nosing PVC
45x42x3 mm

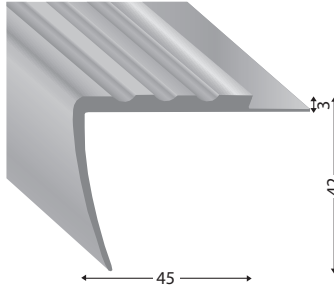

Artikel-Nr. article-no.	Farbe colour	VE unit
45423 SCHW	schwarz/black	50
45423 GRAU	grau/grey	50
45423 BEIGE	beige/beige	50
45423 BRAUN	braun/brown	50

Preis/Stange price/piece	
250 cm	250 cm
Lagerware	Bestellware
16,09	
16,09	
16,09	
16,09	

Treppenkante PVC
Stair nosing PVC
40x25x2 mm

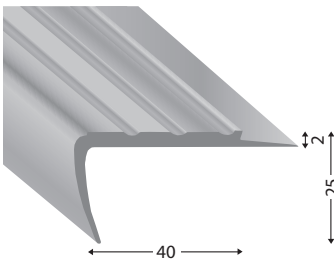

Artikel-Nr. article-no.	Farbe colour	VE unit
40252 SCHW	schwarz/black	50
40252 GRAU	grau/grey	50
40252 BEIGE	beige/beige	50
40252 BRAUN	braun/brown	50

Preis/Stange price/piece	
250 cm	250 cm
Lagerware	Bestellware
13,65	
13,65	
13,65	
13,65	

Treppenkante PVC
Stair nosing PVC
50x40 mm

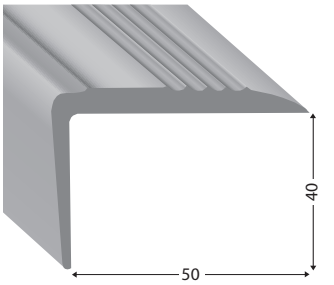

Artikel-Nr. article-no.	Farbe colour	VE unit
1990 SCHWARZ	schwarz/black	40 m
1990 GRAU	grau/grey	40 m
1990 BEIGE	beige/beige	40 m
1990 BRAUN	braun/brown	40 m

Preis/Stange price/piece	
400 cm	400 cm
Lagerware	Bestellware
19,48	
19,48	
19,48	
19,48	

Hohlkehlenprofil PVC
Cove former PVC
16x16 mm

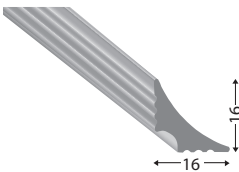

Artikel-Nr. article-no.	Farbe colour	VE unit
20000 SCHW	schwarz/black	60 m

Preis/Rolle price/roll	
6000 cm	6000 cm
Lagerware	Bestellware
102,83	

Hohlkehlenprofil PVC
Cove former PVC
25x25 mm

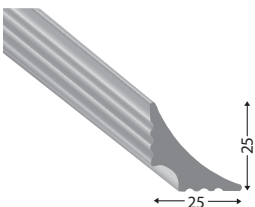

Artikel-Nr. article-no.	Farbe colour	VE unit
20399 1111	schwarz/black	25 m

Preis/Rolle price/roll	
2500 cm	2500 cm
Lagerware	Bestellware
77,85	



SWITCHTEC

SIGAN 1

75cm x 25 m

inkl. 1 Rolle Sigantape 50 mm x 25 m (ca. 20 m² inkl. Tape)

1 Rolle/VE

40 VE/Palette

benötigt Planus
Spezial-Vorstrich



für < neue PVC-, CV-Beläge, Textile Beläge
AUF > Spachtelmasse, Calciumsulfatestrich, Spanplatten
Später garantiert rückstandsfrei entfernbar

Artikel-Nr.
article-no.

VE
unit

Preis/Rolle
price/roll

SIGAN 1

ab 1
ab 2
ab 12
ab 40

Lagerware	Bestellware
403,60	
391,50	
379,38	
363,24	

PLANUS 1025

Voranstrich SIGAN 1

für ca. 20 m²

Spezialvorstrich in Kanister

2,5 kg für 25 m²



für < Sigan 1
AUF > Spachtelmasse, Calciumsulfatestrich, Spanplatten

Artikel-Nr.
article-no.

VE
unit

Preis/Kanister
price/piece

PLANUS 1025

1x2,5 kg
3x2,5 kg
12x2,5 kg
36x2,5 kg

Lagerware	Bestellware
49,49	
48,01	
46,52	
44,56	

SIGAN 2

75 cm x 25 m

inkl. 1 Rolle Sigan tape 50 mm x 25 m (ca. 20 m² inkl. Tape)

1 Rolle/VE

40 VE/Palette



für < neue PVC-, CV-Beläge, Textile Beläge
AUF > bestehende PVC-, CV-Beläge, Linoleum
Später garantiert rückstandsfrei entfernbar

Artikel-Nr.
article-no.

VE
unit

Preis/Rolle
price/roll

SIGAN 2

ab 1
ab 2
ab 12
ab 40

Lagerware	Bestellware
367,71	
356,68	
345,64	
330,95	

Für leitfähige Verlegung geeignet-mit Kupferband!

SIGAN 3

75 cm x 25 m

inkl. 1 Rolle Sigan tape 50 mm x 25 m (ca. 20 m² inkl. Tape)

1 Rolle/VE

40 VE/Palette



für < neue Textile Beläge
AUF > bestehende Parkett, Laminat, keramische Beläge
Später garantiert rückstandsfrei entfernbar

Artikel-Nr.
article-no.

VE
unit

Preis/Rolle
price/roll

SIGAN 3

ab 1
ab 2
ab 12
ab 40

Lagerware	Bestellware
367,71	
356,68	
345,64	
330,95	

SIGAN ELEMENTS PLUS

75 cm x 25 m
inkl. 1 Rolle Sigan Elements Plus Tape 50 mm x 25 m
(ca. 20 m² inkl. Tape)
1 Rolle/VE
40 VE/Palette

benötigt Planus
Spezial-Vorstrich



für < PVC-Designbeläge und PVC-Fliesen
AUF > Spachtelmasse, Spannplatte, Metall

Später garantiert rückstandsfrei entfernbar

SIGAN ELEMENTS

75 cm x 25 m
inkl. 1 Rolle Sigan Elements Plus Tape 50 mm x 25 m
(ca. 20 m² inkl. Tape)
1 Rolle/VE
40 VE/Palette



für < PVC-Designbeläge und PVC-Fliesen
AUF > bestehende Nutzbeläge

Später garantiert rückstandsfrei entfernbar

SIGAWAY

100 cm x 25 m (= 25 m²)
1 Rolle/VE
40 VE/Palette



für < neue Textile Beläge
AUF > bestehende Textile Beläge

SUPERTAPE 7900 SUPER

50 mm x 25 m
1 Karton=12 Rollen
Palette= 504 Rollen

Rand- und Nahtverstärkung bei Sigaway-Flächenverlegung

BULLRAN 45

45 mm x 25 m
1 Karton=4 Rollen
Palette=576 Rollen



für < gekettelte Teppichsockel 50 - 60 mm
AUF > Untergründe bis 3 mm Struktur

Artikel-Nr.
article-no.

VE
unit

Preis/Rolle
price/roll

SIGAN E PLUS

- ab 1
- ab 3
- ab 12
- ab 40

Lagerware	Bestellware
	367,71
	356,68
	345,64
	330,95

Artikel-Nr.
article-no.

VE
unit

Preis/Rolle
price/roll

SIGAN E

- ab 1
- ab 3
- ab 12
- ab 40

Lagerware	Bestellware
367,71	
356,68	
345,64	
330,95	

Artikel-Nr.
article-no.

VE
unit

Preis/Rolle
price/roll

77

- ab 1
- ab 3
- ab 12
- ab 40

Lagerware	Bestellware
	426,36
	413,57
	400,78
	383,72

Artikel-Nr.
article-no.

VE
unit

Preis/Rolle
price/roll

7900 5025

- ab 1
- ab 12
- ab 36
- ab 144
- ab 252

Lagerware	Bestellware
	30,62
	29,16
	28,28
	27,40
	26,25

Artikel-Nr.
article-no.

VE
unit

Preis/Rolle
price/roll

6700 4525

- ab 1
- ab 4
- ab 16
- ab 32
- ab 64
- ab 288

Lagerware	Bestellware
	28,78
	27,40
	26,56
	26,17
	25,75
	24,66

CONTACT 40

40 mm x 50 m
1 Karton=6 Rollen
Palette=576 Rollen



für < gekettelte Teppichsockel 45 - 55 mm
AUF > Untergründe bis 1,5 mm Struktur

Artikel-Nr.
article-no.

6650 4050

VE
unit

ab 1
ab 6
ab 24
ab 48
ab 96
ab 360

Preis/Rolle
price/roll

Lagerware	Bestellware
30,70	
29,24	
28,36	
27,92	
27,48	
26,31	

CONTACT 50

50 mm x 50 m
1 Karton=5 Rollen
Palette=480 Rollen



für < gekettelte Teppichsockel 60 - 70 mm
AUF > Untergründe bis 1,5 mm Struktur

Artikel-Nr.
article-no.

6650 5050

VE
unit

ab 1
ab 5
ab 20
ab 80
ab 300

Preis/Rolle
price/roll

Lagerware	Bestellware
32,10	
30,58	
29,66	
28,74	
27,53	

CONTACT 70

70 mm x 50 m
1 Karton=3 Rollen
Palette=288 Rollen



für < gekettelte Teppichsockel 75 - 85 mm
AUF > Untergründe bis 1,5 mm Struktur

Artikel-Nr.
article-no.

6650 7050

VE
unit

ab 1
ab 3
ab 12
ab 48
ab 180

Preis/Rolle
price/roll

Lagerware	Bestellware
53,73	
51,18	
49,66	
48,11	
46,06	

CONTACT 85

85 mm x 50 m
1 Karton=3 Rollen
Palette=288 Rollen



für < gekettelte Teppichsockel 90 - 110 mm
AUF > Untergründe bis 1,5 mm Struktur

Artikel-Nr.
article-no.

6650 8550

VE
unit

ab 1
ab 3
ab 12
ab 48
ab 180

Preis/Rolle
price/roll

Lagerware	Bestellware
65,73	
62,60	
60,71	
58,83	
56,33	

TOPTAC 35

35 mm x 50 m
1 Karton=4 Rollen
Palette=420 Rollen



für < Kernsockelleisten
AUF > Untergründe bis 1 mm Struktur

Artikel-Nr.
article-no.

6801 3550

VE
unit

ab 1
ab 4
ab 16
ab 64
ab 208

Preis/Rolle
price/roll

Lagerware	Bestellware
47,69	
45,42	
44,04	
42,68	
40,86	

REMUR 45
45 cm x 50 m
1 Karton=4 Rollen
Palette=240 Rollen



für < PVC-Weichsockelleisten
AUF > glatte Untergründe

REMUR 55
55 cm x 50 m
1 Karton=4 Rollen
Palette=240 Rollen



für < PVC-Weichsockelleisten
AUF > glatte Untergründe

REMUR 95
95 cm x 50 m
1 Karton=2 Rollen
Palette=120 Rollen



für < PVC- und CV-Hohlkehle-Systeme
AUF > glatte Untergründe

POMUR 46
46 mm x 50 m
1 Karton=4 Rollen
Palette=240 Rollen



für < DÖLLKEN Weichsockelleiste WL 50 life
AUF > Untergründe bis 1 mm gleichmässige Struktur

Kleber für WL 50 Polyolefinleiste siehe Seite 206

GOMAN 50
50 mm x 50 m
1 Karton = 4 Rollen
Palette=240 Rollen



für < NORA® Kautschuk-Sockelleisten
AUF > Untergründe bis 1 mm Struktur

GOMAN 90
90 mm x 50 m
1 Karton=2 Rollen
Palette=120 Rollen



für < NORA® Kautschuk-Hohlkehlen-Systeme
AUF > Untergründe bis 1 mm Struktur

Artikel-Nr.
article-no.

REMUR 45

VE
unit

Preis/Rolle
price/roll

- ab 1
- ab 4
- ab 16
- ab 64
- ab 120

Lagerware	Bestellware
61,45	
58,52	
56,76	
55,01	
52,67	

Artikel-Nr.
article-no.

REMUR 55

VE
unit

Preis/Rolle
price/roll

- ab 1
- ab 4
- ab 16
- ab 64
- ab 120

Lagerware	Bestellware
	74,99
	71,42
	69,26
	67,13
	64,27

Artikel-Nr.
article-no.

REMUR 95

VE
unit

Preis/Rolle
price/roll

- ab 1
- ab 2
- ab 8
- ab 32
- ab 60

Lagerware	Bestellware
	128,33
	122,22
	118,54
	114,89
	110,00

Artikel-Nr.
article-no.

6500 4650

VE
unit

Preis/Rolle
price/roll

- ab 1
- ab 4
- ab 16
- ab 64
- ab 120

Lagerware	Bestellware
55,84	
53,19	
51,60	
49,99	
47,88	

Artikel-Nr.
article-no.

6900 5050

VE
unit

Preis/Rolle
price/roll

- ab 1
- ab 4
- ab 16
- ab 64
- ab 120

Lagerware	Bestellware
68,38	
65,12	
63,18	
61,22	
58,60	

Artikel-Nr.
article-no.

6900 9050

VE
unit

Preis/Rolle
price/roll

- ab 1
- ab 2
- ab 8
- ab 32
- ab 60

Lagerware	Bestellware
	118,50
	112,86
	109,47
	106,09
	101,57

LINOMUR 45

45 mm x 50 m
1 Karton= 4 Rollen
Palette= 240 Rollen



für < Linoleum Belagstreifen als Stellsockel
AUF > Untergründe bis 1,5 mm Struktur

LINOMUR 90

90 mm x 50 m
1 Karton= 2 Rollen
Palette= 120 Rollen



für < Linoleumstreifen und Linoleum Hohlkehprofile
AUF > Untergründe bis 1,5 mm Struktur

STEPTEC 150 auf Setzstufen

150 mm x 25 m
1 Karton = 1 Rolle
1 Palette = 210 Rollen



für < Textile-, Linoleum, PVC- und CV-Beläge
AUF > Untergründe bis 1 mm Strukturhöhe

STEPTEC 220 auf Tritt- und Setzstufen

220 mm x 25 m
1 Karton = 1 Rolle
1 Palette = 140 Rollen



für < Textile-, Linoleum, PVC- und CV-Beläge
AUF > Untergründe bis 1 mm Strukturhöhe

SIGA GUMMI-HAMMER

für das Anschlagen von Sockelleisten



SIGA ANREIBKORK - Textilbezug

für das Anreiben von Sigan, Sigaway und Bodenbelägen



UZIN Injektionsklebstoff MK 37 - (MK) RK37

zur Reparatur von Parkett-Hohlstellen
250 g
1 Karton = 2 Stück

Artikel-Nr. article-no.	Farbe colour	VE unit	Preis/Rolle price/roll
Linomur 45		ab 1	41,05
		ab 4	39,08
		ab 16	37,91
		ab 64	36,74
		ab 240	35,17
Linomur 90		ab 1	82,68
		ab 2	78,73
		ab 8	76,37
		ab 32	74,01
		ab 120	70,85
STEPTEC 150		ab 1	60,19
		ab 4	58,39
		ab 16	56,58
		ab 60	54,17
STEPTEC 220		ab 1	88,26
		ab 4	85,61
		ab 16	82,97
		ab 32	79,44
47450	weiß/white	1	14,00
72642		1	38,67
MK37		1	47,34



KLEBEBÄNDER

ABDECKBÄNDER

VERPACKUNGSBÄNDER

TEPPICHVERLEGEKLEB

Polypropylenträger mit synthetischem weißem
Kunstharzkleber - nicht weichmacherfest

13B



Artikel-Nr. <i>article-no.</i>	Maß <i>size</i>	VE <i>unit</i>	Preis/Rolle <i>price/roll</i>
4100 5/5	50 mm x 5 m	52	2,99
4100 10/5	50 mm x 10 m	48	4,47
4100 25/5	50 mm x 25 m	24	11,29

MONTAGESCHAUMBAND

Polyesterschaum weiß, synthetischer Kunstharzkleber



Artikel-Nr. <i>article-no.</i>	Maß <i>size</i>	VE <i>unit</i>	Preis/Rolle <i>price/roll</i>
4300 15/19	19 mm x 15 m	32	14,19

MALERABDECKBAND

Feinkrepp



Artikel-Nr. <i>article-no.</i>	Maß <i>size</i>	VE <i>unit</i>	Preis/Rolle <i>price/roll</i>
4600 19/50	19 mm x 50 m	48	2,31
4600 25/50	25 mm x 50 m	36	2,95
4600 30/50	30 mm x 50 m	32	3,57
4600 38/50	38 mm x 50 m	24	3,95
4600 50/50	50 mm x 50 m	24	4,74

VERPACKUNGSBAND



Artikel-Nr. <i>article-no.</i>	Maß <i>size</i>	VE <i>unit</i>	Preis/Rolle <i>price/roll</i>
5360 38MM BR	38 mm	48	3,16
5360 50MM BR	50 mm	36	4,03



SILIKON

ACRYL

KLEBER

FUGENMASSE

Qualitäts SILIKON und ACRYL zum Dichten und Dämmen

13C

SILIKON und ACRYL DICHTSTOFF - 310 ml



Artikel-Nr. article-no.	Farbe colour	Maß size	VE unit	Preis/Stück price/piece
120 200 003	transparent/transparent	310 ml	12	8,32
120 200 010	weiß/white	310 ml	12	8,32
120 200 020	silbergrau/silvergrey	310 ml	12	8,32
120 200 024	fugengrau/jointgrey	310 ml	12	8,32
120 200 028	manhattan/manhattan	310 ml	12	8,32
120 200 032	betongrau/cementgrey	310 ml	12	8,32
120 200 036	anthrazit/anthrazit	310 ml	12	8,32
ACRYL D	weiß/white	310 ml	20	5,58

ferax® Sanitär-Silikon ist ein hochwertiger, anwendungsfertiger Einkomponenten-Silikon-Dichtstoff (Acetat-System)

Anwendungsbereich:

In Feuchträumen wie Badezimmern etc. ferax® Sanitär-Silikon wird besonders bei Anschlussfugen an Badewannen, Waschbecken, Duschkabinen, bei Dehnungs- und Anschlussfugen bei keramischen Wand und Bodenbelägen sowie zur Abdichtung bei sanitären Installationen eingesetzt. ferax® Sanitär-Silikon haftet auf allen gebräuchlichen Baustoffen im Sanitärbereich wie z. B. Alu eloxiert, glasierte Fliesen, Glas, Kacheln, viele Kunststoffe, Porzellan, etc. ferax® Sanitär-Silikon enthält fungizide und bakterizide Wirkstoffe, die einem Befall durch Mikroorganismen entgegenwirken.

Vorbereitung des Untergrundes:

Zur Unterstützung der schimmelabweisenden Eigenschaften wird empfohlen, die Fugenoberflächen und die angrenzenden Flächen mit Reinigungs- und Desinfektionsmittel sauber zu halten.

Verarbeitung:

ferax® Sanitär-Silikon ist aufgrund seiner besonderen Viskosität sehr gut zu verarbeiten und zeichnet sich durch eine gute Glättfähigkeit und Modellierbarkeit aus. ferax® Sanitär-Silikon ist beständig gegen handelsübliche Reinigungs- und Desinfektionsmittel.

POWERGRIP®, LÖSUNGSMITTELFREIER MONTAGEKLEBER

4000 PG - 290 ml



Artikel-Nr. article-no.	Farbe colour	Maß size	VE unit	Preis/Stück price/piece
4000 PG	weiß/white	290 ml	12	13,44

Anwendungsbereich:

Pastöser Dispersions-Montageklebstoff für verschiedenste Befestigungsarbeiten im Innenbereich an Boden, Wand und Decke. Für PVC-Kernsockelleisten, flache Korksockelleisten, Profile, Dämm- und Dekorplatten, Wandpaneele, Fliesen, PVC, Holz, Kork, u. ä. Haftet hervorragend auf einer Vielzahl von saugfähigen und nicht saugfähigen Untergründen und Materialien, z. B. auf Beton, Putz, Mauerwerk, Keramik, Stein, Holz, Kork, Hart- und Weichschaum, Kunststoffen, Beschichtungen, Alu, Stahlblech u.v. a.

Vorbereitung des Untergrundes:

Der Untergrund muß dauer trocken, sauber, fest und tragfähig sein. Die Klebeflächen sind von Staub und Trennmitteln zu reinigen. Zur Haftverbesserung und zur Staubbindung Untergründe mit geeigneter Grundierung vorstreichen.

Verarbeitung:

POWERGRIP® in die Handspritzpistole einlegen, Klebstoff mit gleichmäßigen Zügen herausdrücken und punkt- oder streifenförmig auf den Untergrund oder das Klebeteil auftragen. Der aufgetragene Klebstoff beginnt nach ca. 10 Minuten mit der Bildung einer Oberflächenhaut. Klebeflächen deshalb sofort oder vor Beginn der Hautbildung zusammenfügen und ggf. fixieren, einspannen oder verspreizen. Gelebte oder verfüllte Stellen so lange vor Wasser oder Feuchtigkeit schützen, bis der Klebstoff eine ledrige, wasserunempfindliche Haut gebildet hat. Klebstoffverunreinigungen in frischem Zustand mit Wasser entfernen.

Verbrauch:

Eine 290 ml-Kartusche reicht aus für ca. 10 lfm Streifen mit Ø ca. 5 mm.

Verarbeitungstemperatur:
Am besten zwischen +15 °C und +20 °C

Wärme- und Kältebeständigkeit:
Für Dauerbeanspruchungen zwischen -30 °C und +70 °C, kurzfristig bis +120 °C.

Ergiebigkeit pro Kartusche:
Bei strangförmigem Auftrag mit 0,5 cm. Düsendurchmesser ca. 10 lfm. Bei punktförmigem Auftrag im Abstand von 30 cm, z.B. auf Platten, ca. 10 qm. Der Klebstoffauftrag muß sich insbesondere nach den zu überbrückenden Unebenheiten richten.

Lösungs- und Reinigungsmittel:
Verdüner

Lagerung: 12 Monate lagerfähig.

LAMINAT FUGENMASSE

FERAX LAMINATFUGENMASSE - 310 ml



Artikel-Nr. article-no.	Farbe colour	Maß size	VE unit	Preis/Stück price/piece
120 150 001	ahorn-esche-fichte matt	310 ml	12	16,57
120 150 002	eiche hell matt	310 ml	12	16,57
120 150 003	eiche dunkel matt	310 ml	12	16,57
120 150 004	buche hell matt	310 ml	12	16,57
120 150 005	buche dunkel matt	310 ml	12	16,57
120 150 006	weiß matt	310 ml	12	16,57
120 150 007	kirschbaum matt	310 ml	12	16,57
120 150 008	nussbaum/eiche kerngeräuchert matt	310 ml	12	16,57
120 150 009	merbau-mahagoni matt	310 ml	12	16,57
120 150 010	wenge matt	310 ml	12	16,57
120 150 011	anthrazit matt	310 ml	12	16,57

ferax® Laminatfugenmasse ist eine hochwertige, einkomponentige Fugenmasse auf neutraler Silikonbasis.

EINSATZBEREICH:

Eignet sich hervorragend zum Verschließen von Übergangsfugen bei Laminatböden, von Fugen bei Zargen zum Boden, bei Übergängen zu Natursteinböden wie Marmor, Granit, Sandstein, Gneis, Terrazzo etc. – keine Gefahr durch das Abwandern von Weichmachern bzw. anderen Stoffen im Randbereich von Natursteinen – keine Randzonenverfärbung. Im Innen- und Außenbereich einsetzbar.

VORTEILE:

- fungizid ausgestattet
- lösemittelfrei
- hoch elastisch
- natursteinverträglich
- weichmacherfrei
- schnelltrocknend

Spezifisches Gewicht:	ca. 1,03 g/cm
Eigenschaft:	pastös, standfest
Hautbildezeit:	ca. 5 min. (bei +23°C und 50% RLF)
Verarbeitungstemperatur:	+5°C bis + 35°C
Wärmebeständigkeit:	-50°C bis +150°C
Modul 100%:	ca. 0,7 N/mm

Lagerung: Bei kühler und trockener Lagerung mind. 18 Monate.
Lieferform: Standardkartusche mit 310 ml.

PARKETT FUGENMASSE

FERAX PARKETT FUGENMASSE - 310 ml



Artikel-Nr. article-no.	Farbe colour	Maß size	VE unit	Preis/Stück price/piece
120 120 001	ahorn-esche-fichte matt	310 ml	12	14,63
120 120 002	eiche hell matt	310 ml	12	14,63
120 120 003	eiche dunkel matt	310 ml	12	14,63
120 120 004	buche hell matt	310 ml	12	14,63
120 120 005	buche dunkel matt	310 ml	12	14,63
120 120 006	weiß matt	310 ml	12	14,63
120 120 007	kirschbaum matt	310 ml	12	14,63
120 120 008	nussbaum-eiche kerngeräuchert matt	310 ml	12	14,63
120 120 009	merbau-mahagoni matt	310 ml	12	14,63
120 120 010	wenge matt	310 ml	12	14,63
120 120 012	eiche gekalkt matt	310 ml	12	14,63

ferax® Parkettfugenmasse ist eine gebrauchsfertige, einkomponentige, silikonfreie und formaldehydfreie Fugenmasse auf der Basis einer hochwertigen Polyacrylat-Dispersion.

EINSATZBEREICH:

Eignet sich hervorragend zum Verschließen von Fugen bei allen Arten von Holzböden, wie z.B. Parkett, Dielen, Holzpflaster, Sockelleisten usw. sowohl vor als auch nach Versiegelung. Zum Verfugen von Sockelleisten und anderen Abschlüssen. Nur für den Innenbereich.

VORTEILE:

- silikonfrei
- lösemittelfrei
- geruchsneutral
- lange lagerfähig
- ohne Verlauffstörungen überversiegelbar
- schleifbar
- schnelltrocknend
- temperaturbeständig: von -20°C bis +80°C

Lagerung: Vor Frost schützen. Kühl und trocken lagern. Originalgebinde sind mindestens 24 Monate lagerfähig.
Lieferform: Standardkartusche mit 310 ml.

FUGENMASSE

13D

TOP ELASTIC FUGENMASSE - 310 ml



Artikel-Nr. article-no.	Farbe colour	Maß size	VE unit	Preis/Stück price/piece
PAFUDIMA AH	ahorn-kiefer-esche	310 ml	10	15,07
PAFUDIMA BU	buche-kirsch	310 ml	10	15,07
PAFUDIMA EI	eiche	310 ml	10	15,07
PAFU EI DK	eiche dunkel	310 ml	10	15,07
PAFU MER	merbau-doussie	310 ml	10	15,07
PAFU NUSS	nuss-teak	310 ml	10	15,07
PAFU WEN	wenge-räuchereiche	310 ml	10	15,07

Lagerware	Bestellware
15,07	
15,07	
15,07	
15,07	
	15,07
15,07	
15,07	

Parkettfugen Dichtmasse - silikonfrei, dauerelastisch, lösemittelfrei, schnell trocknend und schalldämpfend

Ahorn / maple
Kiefer / pine
Esche / ash-tree

Buche / beech
Kirsche / cherry

Eiche / oak

Eiche dunkel / oak dark

Merbau / merbau
Doussie / doussie

Nuss / nut
Teak / teak

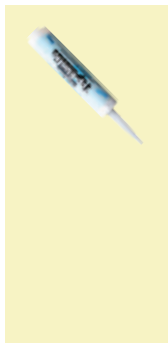



FIX-o-MOLL

TISCHTUCHKLAMMERN

MALER- und VERLEGUNGSBÄNDER

14

MALER FLACHKREPP



3563014

Artikel-Nr.
article-no.

47738 R

Farbe
colour

chamois

Maße
size

38 mm x 50 m

VE/Blister
unit/blister

4

Preis/Blister
price/blister

Lagerware	Bestellware
4,33	
5,35	

3563015

47750 R

chamois

50 mm x 50 m

3



VERLEGE BAND STANDARD

Folienband, vielseitig einsetzbar



3563195

Artikel-Nr.
article-no.

52550 R

Farbe
colour

Maße
size

50 mm x 5 m

VE/Blister
unit/blister

4

Preis/Blister
price/blister

Lagerware	Bestellware
2,72	

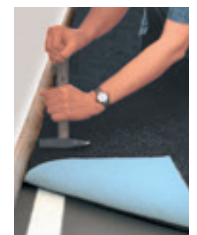

VERLEGE BAND SUPER

Verlegeband Super, mit Gewebeträger, permanent klebend



3563191

Artikel-Nr.
article-no.

50550 R

Farbe
colour

Maße
size

50 mm x 5 m

VE/Blister
unit/blister

4

Preis/Blister
price/blister

3563189

501050 R

50 mm x 10 m

4

3563190

502550 R

50 mm x 25 m

3

Lagerware	Bestellware
3,64	
6,17	
13,84	



GLEITSCHUTZ-, ALU- und KLEBEBAND

ANTI RUTSCHBAND

Selbstklebendes Anti-Rutschband und Strips zur Vermeidung von Rutschgefahren. Erhöhte Trittsicherheit auf Treppen, Leitern, glatten Böden oder bei sonstiger Rutschgefahr auf **3567011** glatten Untergründen.



Artikel-Nr. article-no.	Farbe colour	Maße size	VE/Blister unit/blister	Preis/Blister price/blister
126 R	schwarz	19 mm x 3 m	6	

Lagerware	Bestellware
4,16	



ALU FOLIENDICHTBAND

Zum Dichten und Isolieren bei Dachausbau und Parkettverlegung



3563294

Artikel-Nr. article-no.	Farbe colour	Maße size	VE/Blister unit/blister	Preis/Blister price/blister
8950 R	silber	50 mm x 50 m	4	

Lagerware	Bestellware
4,51	

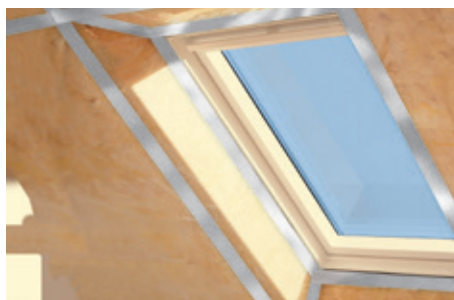

DOPPEL-KLEBEBAND-extra reifest

Ideal zum Befestigen und Verkleben von Postern, Fotos, Ausdrucken usw.



3563347

Artikel-Nr. article-no.	Farbe colour	Maße size	VE/Blister unit/blister	Preis/Blister price/blister
1992 15 R	transparent	15 mm x 10 m	6	

Lagerware	Bestellware
5,25	



ISOLIER- und MONTAGEBÄNDER

POWER STRETCHBAND

Isolierend gegen Strom, wasserresistent
Besonders geeignet für Reparaturen am Kraftfahrzeug, im Haushalt, Hobby-, Sanitär- und Elektrobereich

3563085

Artikel-Nr.
article-no.

Farbe
colour

Maße
size

VE/Blister
unit/blister

Preis/Blister
price/blister

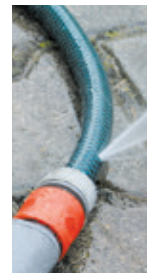
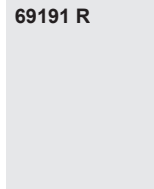

Lagerware	Bestellware
11,10	



POWER MONTAGEBAND 50kg

Doppelseitig klebendes transparentes Montageband erfüllt extrem hohe Ansprüche bei Befestigungen im Außen- und Innenbereich.

3563049

Artikel-Nr.
article-no.

Farbe
colour

Maße
size

VE/Blister
unit/blister

Preis/Blister
price/blister

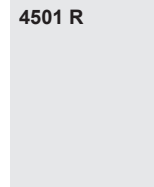

Lagerware	Bestellware
7,19	



MONTAGE- und PACKBAND

MONTAGEBAND für Spiegel beidseitig stark klebend

Montageband zur dauerhaften Befestigung von Spiegeln, Spiegelkacheln u.v.m., feuchtigkeitsbeständig, für den Innenbereich.

3563056



Artikel-Nr. article-no.	Farbe colour	Maße size	VE/Blister unit/blister	Preis/Blister price/blister
4500 R	weiß	19 mm x 5 m	6	7,42



MEGA STRIPS

Mega-Strips zur dauerhaften Befestigung von Wandhaken.
Doppelseitig stark klebend, rückstandslos ablösbar.

3563345



Artikel-Nr. article-no.	Farbe colour	Maße size	VE/Blister unit/blister	Preis/Blister price/blister
4545 R	weiß	20 mm x 50 m	15	3,53



PACKBAND PVC

3563334
3563333

Artikel-Nr. article-no.	Farbe colour	Maße size	VE/Blister unit/blister	Preis/Blister price/blister
6650 R 00	transparent	50 mm x 66 m	6	4,12
6650 R 07	braun	50 mm x 66 m	6	4,12



BIG DUO PARKETT-GLEITER

schützen und schonen Ihre wertvollen Bodenbeläge (Parkett, Laminat, Marmor, Fliesen, glatte Kunststoffbeläge). Durch die extra gleitfähige Oberfläche der Big-Duo Parkett-Gleiter lassen sich Möbelstücke (Stühle, Tische usw.) sanft, leise und sicher; ohne Beschädigung der Bodenflächen verschieben. Die Duo-Filzschicht mit der extra starken Klebeausrüstung garantiert eine lange Lebensdauer der Big-Duo Parkett-Gleiter.

... für empfindliche, glatte Böden



14

BIG DUO Parkettgleiter Ø 22 mm

Blister=16 Stück



3566001

Artikel-Nr.
article-no. **7062216 R**

Farbe
colour natur

Maße
size 22 mm

VE/Blister
unit/blister 6

Lagerware	Bestellware
2,53	

BIG DUO Parkettgleiter Ø 28 mm

Blister=9 Stück



3566022

Artikel-Nr.
article-no. **7062809 R**

Farbe
colour natur

Maße
size 28 mm

VE/Blister
unit/blister 6

Lagerware	Bestellware
2,70	

BIG DUO Parkettgleiter Ø 35 mm

Blister=4 Stück



3566023

Artikel-Nr.
article-no. **7063504 R**

Farbe
colour natur

Maße
size 35 mm

VE/Blister
unit/blister 6

Lagerware	Bestellware
2,53	

BIG DUO Parkettgleiter 20 x 20 mm

Blister=16 Stück



3566043

Artikel-Nr.
article-no. **7062016 R**

Farbe
colour natur

Maße
size 20 x 20 mm

VE/Blister
unit/blister 6

Lagerware	Bestellware
2,53	

BIG DUO Parkettgleiter 20 x 40 mm

Blister=8 Stück



3566064

Artikel-Nr.
article-no. **7062008 R**

Farbe
colour natur

Maße
size 20 x 40 mm

VE/Blister
unit/blister 6

Lagerware	Bestellware
2,70	

BIG DUO Parkettgleiter 80 x 95 mm

Blister=1 Stück



3566065

Artikel-Nr.
article-no. **7068001 R**

Farbe
colour natur

Maße
size 80 x 95 mm

VE/Blister
unit/blister 6

Lagerware	Bestellware
2,53	

FILZ GLEITER und FILZ ZUSCHNITT

selbstklebend

aus abriebfestem, robustem Nadelfilz schützen Oberflächen und gewährleisten ein spielend leichtes, geräuschfreies Verschieben von Möbelstücken und Gegenständen auf empfindlichen, glatten Untergründen.

- spezial Kraftklebeausüstung
- kinderleicht zu montieren
- sortiert in braun und weiß
- sortiert in den gängigen Größen bzw. individuell zuschneidbar.

... für glatte Böden

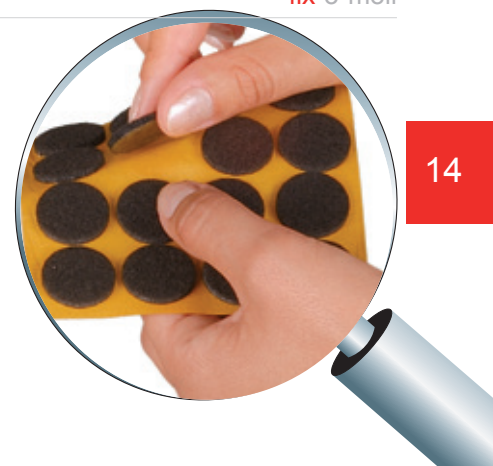

FILZ-GLEITER - rund selbstklebend



Artikel-Nr. article-no.	Farbe colour	Maße size	Blister/Stück blister/piece	VE/Blister unit/blister	Preis/Blister price/blister
3566300	75 R 01	weiß	17 mm	20	15
3566302	76 R 01	weiß	22 mm	16	15
3566306	77 R 01	weiß	28 mm	8	15
3566300	74 R 01	weiß	35 mm	4	15
3566340	75 R 07	braun	17 mm	20	15
3566342	76 R 07	braun	22 mm	16	15
3566346	77 R 07	braun	28 mm	8	15
3566340	74 R 07	braun	35 mm	4	15

Lagerware	Bestellware
1,30	
1,30	
1,30	
1,30	
1,30	
1,30	
1,30	
1,30	

FILZ-GLEITER - eckig selbstklebend



Artikel-Nr. article-no.	Farbe colour	Maße size	Blister/Stück blister/piece	VE/Blister unit/blister	Preis/Blister price/blister
3566320	78 R 01	weiß	22x22 mm	16	15
3566326	79 R 01	weiß	22x36 mm	8	15
3566327	80 R 01	weiß	16x44 mm	8	15
3566376	79876 R 01	weiß	div. Größen	100	10
3566360	78 R 07	braun	22x22 mm	16	15
3566366	79 R 07	braun	22x36 mm	8	15
3566367	80 R 07	braun	16x44 mm	8	15

Lagerware	Bestellware
1,30	
1,30	
1,30	
5,02	
1,30	
1,30	
1,30	

FILZ-ZUSCHNITTE selbstklebend



Artikel-Nr. article-no.	Farbe colour	Maße size	Blister/Stück blister/piece	VE/Blister unit/blister	Preis/Blister price/blister
3566330	60 R 01	weiß	100x100 mm	1	15
3566331	59 R 01	weiß	100x200 mm	1	15
3566332	5905 R 01	weiß	100x200 mm	5	6
3566333	5920 R 01	weiß	200x200 mm	1	15
3566370	60 R 07	braun	100x100 mm	1	15
3566371	59 R 07	braun	100x200 mm	5	15
3566372	5905 R 07	braun	100x200 mm	1	6
3566373	5920 R 07	braun	200x200 mm	1	15

Lagerware	Bestellware
1,36	
1,88	
5,77	
2,74	
1,36	
1,88	
5,77	
2,74	

ALLROUND EASY GLIDER

selbstklebend oder zum Schrauben

Allround-Easy-Glider aus PTFE (Polytetrafluorethylen). Ideal zum Verschieben von Möbeln, Schränken und schweren Haushaltsgeräten mit geringstem Kraftaufwand. Auf allen Bodenbelägen wie Laminat, Fliesen, Teppichboden, Linoleum usw. bewegen Allround Easy-Glider Gegenstände wie auf Rollen. Mühelos, sicher und schonend.

... für viele Bodenbeläge



EASY GLIDER Ø 30 mm

selbstklebend

Blister=4 Stück



3566481

Artikel-Nr.
article-no.

1023004 R

Farbe
colour

grau/schwarz

Maße
size

30 mm

VE/Blister
unit/blister

6

Preis/Blister
price/blister

Lagerware	Bestellware
5,48	

EASY GLIDER Ø 40 mm

selbstklebend

Blister=4 Stück



3566482

Artikel-Nr.
article-no.

1024004 R

Farbe
colour

grau/schwarz

Maße
size

40 mm

VE/Blister
unit/blister

6

Preis/Blister
price/blister

Lagerware	Bestellware
6,29	

EASY GLIDER Ø 50 mm

selbstklebend

Blister=4 Stück



3566483

Artikel-Nr.
article-no.

1025004 R

Farbe
colour

grau/schwarz

Maße
size

50 mm

VE/Blister
unit/blister

5

Preis/Blister
price/blister

Lagerware	Bestellware
7,44	

EASY GLIDER Ø 22 mm

selbstklebend - flach

Blister=12 Stück



3566496

Artikel-Nr.
article-no.

1012212 R

Farbe
colour

grau/schwarz

Maße
size

22 mm

VE/Blister
unit/blister

6

Preis/Blister
price/blister

Lagerware	Bestellware
6,77	

EASY GLIDER Ø 28 mm

selbstklebend - flach

Blister=8 Stück



3566497	Artikel-Nr. article-no.	1012808 R	Farbe colour	grau/schwarz	Maße size	28 mm	VE/Blister unit/blister	6	Preis/Blister price/blister	
									Lagerware	Bestellware
									7,44	

14

EASY GLIDER 80x100 mm

selbstklebend - flach

Blister=1 Stück



3566499	Artikel-Nr. article-no.	1018001 R	Farbe colour	grau/schwarz	Maße size	80x100 mm	VE/Blister unit/blister	6	Preis/Blister price/blister	
									Lagerware	Bestellware
									6,73	

EASY GLIDER Ø 22 mm

zu Schrauben

Blister=8 Stück



3566106	Artikel-Nr. article-no.	1022208 R	Farbe colour	grau/schwarz	Maße size	22 mm	VE/Blister unit/blister	6	Preis/Blister price/blister	
									Lagerware	Bestellware
									6,96	

EASY GLIDER Ø 38 mm

zu Schrauben

Blister=4 Stück



3566127	Artikel-Nr. article-no.	1023804 R	Farbe colour	grau/schwarz	Maße size	38 mm	VE/Blister unit/blister	6	Preis/Blister price/blister	
									Lagerware	Bestellware
									6,73	

FILZ-GLEITER mit Stift

- einfach zu montieren
- sortiert in braun und weiß, in den gängigsten Größen
- sicherer Halt durch Stift-Befestigung

... für empfindliche, glatte Böden



FILZ-GLEITER mit Stift



Artikel-Nr. article-no.	Farbe colour	Maße size	Blister/Stück blister/piece	VE/Blister unit/blister	Preis/Blister price/blister
3566201	71 R	weiß	20 mm	8	4
3566202	7116 R 01	weiß	20 mm	16	4
3566204	72 R	weiß	24 mm	8	4
3566207	73 R	weiß	28 mm	4	4
3566210	71 R 07	braun	20 mm	8	4
3566211	7116 R 07	braun	20 mm	16	4
3566213	72 R 07	braun	24 mm	8	4
3566216	73 R 07	braun	28 mm	4	4

Lagerware	Bestellware
3,26	
6,63	
3,59	
2,63	
3,26	
6,63	
3,59	
2,63	

WOLLFILZGLEITER 24 mm

Blister=4 Stück



3566147

Artikel-Nr. article-no.	Farbe colour	Maße size	VE/Blister unit/blister	Preis/Blister price/blister
768 R	natur	24 mm	4	

Lagerware	Bestellware
2,55	

KUNSTSTOFF-GLEITER mit Stift

- einfach zu montieren
- sortiert in braun und weiß, in den gängigsten Größen
- sicherer Halt durch Stift-Befestigung

... für glatte und textile Böden



KUNSTSTOFF-GLEITER mit Stift



3566250
3566251
3566252

Artikel-Nr. article-no.	Farbe colour	Maße size	Blister/Stück blister/piece	VE/Blister unit/blister	Preis/Blister price/blister
91 R	weiß	18 mm	8	4	
92 R	weiß	22 mm	8	4	
93 R	weiß	30 mm	4	4	

Lagerware	Bestellware
3,78	
4,56	
3,41	

ANSCHLAGDÄMPFER und OBERFLÄCHENSCHUTZ

ANSCHLAGLÄRM-STOPPER

Selbstklebend

Absorbieren den beim An- und Zuschlagen von Türen und Schubläden entstehenden Lärm

Blister= 24 Stück

3566411
3566412

Artikel-Nr.
article-no.

Farbe
colour

Maße
size

VE/Blister
unit/blister

Preis/Blister
price/blister

20 R 01
20 R 07

weiß
braun

22x8x4 mm
22x8x4 mm

15
15

Lagerware	Bestellware
1,80	1,80

14



RUTSCH- und LÄRMSTOPPER

Selbstklebend

Stoppt Rutschen, Anschlaglärm, Vibrationen und Kratzer

3566423
3566424

Artikel-Nr.
article-no.

Farbe
colour

Maße
size

Blister
blister

VE/Blister
VE/blister

Preis/Blister
price/blister

18 R
19 R

transparent
transparent

8 mm
12 mm

50
28

15
15

Lagerware	Bestellware
3,82	
4,22	



TÜR-STOPPER mit Schraube

Blister= 2 Stück

3566683
3566680
3566681
3566682

Artikel-Nr.
article-no.

Farbe
colour

Maße
size

VE/Blister
unit/blister

Preis/Blister
price/blister

37 R 00
37 R 01
37 R 06
37 R 07

transparent
weiß
beige
braun

5
5
5
5

Lagerware	Bestellware
2,99	
2,99	
2,99	
	2,99



ANSCHLAGDÄMPFER und OBERFLÄCHENSCHUTZ

14

WASCHMASCHINEN Vibrationsdämpfer

Blister= 4 Stück



3566287

Artikel-Nr. article-no.	Farbe colour	Maße size	VE/Blister unit/blister	Preis/Blister price/blister
3566287	weiß		4	6,69

Lagerware	Bestellware
6,69	

WAND-PUFFER

Selbstklebend

Blister= 2 Stück



3566670
3566631
3566636
3566630
3566635
3566602
3566606
3566611

Artikel-Nr. article-no.	Farbe colour	Maße size	VE/Blister unit/blister	Preis/Blister price/blister
2222 R 01	weiß	22 mm	5	2,55
2230 R 01	weiß	30 mm	5	2,82
2230 R 06	beige	30 mm	5	2,82
2240 R 01	weiß	40 mm	5	3,22
2240 R 06	beige	40 mm	5	3,22
2260 R 01	weiß	60 mm	5	3,51
2260 R 06	beige	60 mm	5	3,51
2260 R 07	braun	60 mm	5	3,51

Lagerware	Bestellware
2,55	
2,82	
2,82	
3,22	
3,22	
3,51	
3,51	
3,51	



ECKEN-SCHUTZ

Selbstklebend

Blister= 2 Stück



3566667
3566668

Artikel-Nr. article-no.	Farbe colour	Maße size	VE/Blister unit/blister	Preis/Blister price/blister
2232 R 01	weiß	25 mm	5	4,43
2232 R 06	beige	25 mm	5	4,43

Lagerware	Bestellware
4,43	
4,43	



PROFIL- und HOHLPROFIL-GUMMIDICHTUNGEN aus ATPK*

Selbstklebende, leicht anzubringende Profil- und Hohlprofil-Gummidichtungen sparen Heizkosten und stoppen Zugluft, Kälte, Lärm und Staub.

*ATPK Äthylen-Propylen – Terpolymer Kautschuk

PROFIL- und HOHLPROFIL

Selbstklebend
6 x 9 mm



Artikel-Nr. article-no.	Farbe colour	Maße size	VE/Blister unit/blister
3565235	2006 R 01 weiß	6 x 9 mm	6
3565240	2006 R 07 braun	6 x 9 mm	6

Lagerware	Bestellware
5,39	
5,39	



PROFIL- und HOHLPROFIL

Selbstklebend
5,5 x 9 mm



Artikel-Nr. article-no.	Farbe colour	Maße size	VE/Blister unit/blister
3565254	2108 R 01 weiß	5,5 x 9 mm	6
3565255	2108 R 07 braun	5,5 x 9 mm	6

Lagerware	Bestellware
8,07	
8,07	

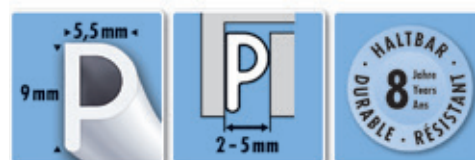

PROFIL- und HOHLPROFIL

Selbstklebend
6 x 9 mm



Artikel-Nr. article-no.	Farbe colour	Maße size	VE/Blister unit/blister
3565265	2206 R 01 weiß	6 x 9 mm	6
3565269	2206 R 07 braun	6 x 9 mm	6

Lagerware	Bestellware
6,58	
6,58	



TÜRDICHTUNGEN

14

ALU-TÜRDICHTUNG für glatte, leicht unebene und textile Böden im Außenbereich

mit Roßhaarbürste für Spaltenbreiten bis max. 20 mm



3565305

3565306

Artikel-Nr. article-no.	Farbe colour	Maße size	VE/Blister unit/blister	Preis/Blister price/blister
41 R	silber	100 cm	10	14,67
42 R	bronze	100 cm	10	18,33



Lagerware	Bestellware
14,67	
18,33	

KUNSTSTOFF-TÜRDICHTUNG für glatte, leicht unebene und textile Böden im Innenbereich

mit superweicher Nylonbürste für Spaltenbreiten bis maximal 18-mm



Artikel-Nr. article-no.	Farbe colour	Maße size	VE/Blister unit/blister	Preis/Blister price/blister
40 K WEISS	weiß	100 cm	24	7,44
40 K BRAUN	braun	100 cm	24	7,44



Lagerware	Bestellware
7,44	
7,44	

KUNSTSTOFF-TÜRDICHTUNG für glatte, leicht unebene und textile Böden im Innenbereich

mit PP-Kunststoffbürste, für Spaltenbreiten bis maximal 20-mm



3565342

3565343

3565341

Artikel-Nr. article-no.	Farbe colour	Maße size	VE/Blister unit/blister	Preis/Blister price/blister
46 R 01	weiß	100 cm	10	6,35
46 R 07	braun	100 cm	10	6,35
46 R 00	transparent	100 cm	10	7,23



Lagerware	Bestellware
6,35	
6,35	
7,23	

SOCKELLEISTEN

SESSELLEISTE PVC

Selbstklebend
50 x 15 mm
5lfm/Rolle



- 3565014
- 3565015
- 3565016
- 3565018
- 3565019
- 3565020
- 3565021
- 3565022
- 3565023
- 3565025

Artikel-Nr. article-no.	Farbe colour	Maße size	VE/Blister unit/blister
201 R	weiß	50 x 15 mm	9
204 R	hellgrau	50 x 15 mm	9
205 R	grau	50 x 15 mm	9
206 R	beige	50 x 15 mm	9
207 R	braun	50 x 15 mm	9
208 R	schwarz	50 x 15 mm	9
210 R	eiche	50 x 15 mm	9
211 R	nuss	50 x 15 mm	9
217 R	buche	50 x 15 mm	9
230 R	esche weiß	50 x 15 mm	9

Lagerware	Bestellware
10,91	
10,91	
10,91	
10,91	
10,91	
10,91	
11,27	
11,27	
11,27	
11,27	



SESSELLEISTE PVC

NICHT selbstklebend
47 x 18 mm
VE= 10 Blister



Artikel-Nr. article-no.	Farbe colour	Maße size	VE/Blister unit/blister
5010 1236	silbergrau	47 x 18 mm	10
5010 2161	mittelbeige	47 x 18 mm	10
5010 BUCHE	buche	47 x 18 mm	10
5010 G6	graubeige	47 x 18 mm	10
5010 G12	hellgrau	47 x 18 mm	10
5010 G22	blaugrau	47 x 18 mm	10
5010 M12	taupe	47 x 18 mm	10
5010 M20	graubeige	47 x 18 mm	10
5010 M49	saharabeige	47 x 18 mm	10

Lagerware	Bestellware
	15,84
	15,84
	16,57
	15,84
	15,84
	15,84
	15,84
	15,84
	15,84

- 1236 2161 Buche G6 G12 G22 M12 M20 M49

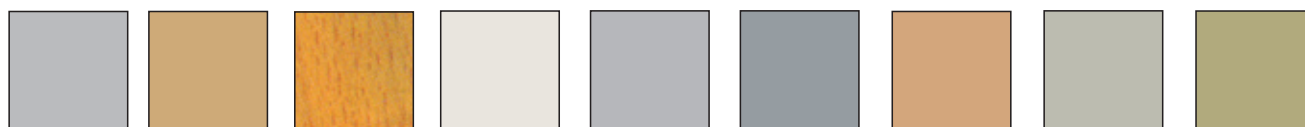

WINKEL-PROFIL

Selbstklebend
18 x 18 mm
5lfm/Rolle



- 3565039
- 3565040
- 3565041
- 3565042
- 3565043
- 3565044
- 3565045
- 3565047

Artikel-Nr. article-no.	Farbe colour	Maße size	VE/Blister unit/blister
101 R	weiß	18 x 18 mm	9
104 R	hellgrau	18 x 18 mm	9
105 R	grau	18 x 18 mm	9
106 R	beige	18 x 18 mm	9
107 R	braun	18 x 18 mm	9
108 R	schwarz	18 x 18 mm	9
110 R	eiche	18 x 18 mm	9
117 R	buche	18 x 18 mm	9

Lagerware	Bestellware
7,90	
7,90	
7,90	
7,90	
7,90	
7,90	
8,07	
8,07	



TISCHTUCHKLAMMERN

14A

TISCHTUCHKLAMMERN

30 mm
Blister= 4 Stück



Artikel-Nr.
article-no.

Farbe
colour

VE/Blister
unit/blister

Preis/Blister
price/blister

650 SB	weiß/white
---------------	------------

25

Lagerware	Bestellware
10,66	

TISCHTUCHKLAMMERN

40 mm
Blister= 4 Stück



Artikel-Nr.
article-no.

Farbe
colour

VE/Blister
unit/blister

Preis/Blister
price/blister

651 SB	weiß/white
---------------	------------

25

Lagerware	Bestellware
11,87	



ZIERPROFILE

ZUBEHÖR

ITALSTYL

Zierprofile aus extrudiertem Polystyrol, FCKW frei & recyclebar, Stangenlänge: 2 Meter

Für die ornamentierten Modelle: 2 Meter $\sim \pm 2\%$

Zum Fixieren der Leisten können Sie ADEFIX Kleber und Stahlstifte verwenden - Alle Fugen mit ADEFIX füllen!

15A

Artikel-Nr. article-no.	Farbe colour	VE/Stange unit/piece	Preis/Stange price/piece	
			200 cm Lagerware	200 cm Bestellware
B 701 8x60 mm	weiß/white	100	6,44	
B 702 30x30 mm	weiß/white	150	3,39	
B 703 45x45 mm	weiß/white	65	6,31	
B 705 35x35 mm	weiß/white	100	4,68	
B 706 50x50 mm	weiß/white	70	5,68	
B 707 50x50 mm	weiß/white	55	6,77	
B 709 14x40 mm	weiß/white	125	5,73	

ITALSTYL

Zierprofile aus extrudiertem Polystyrol, FCKW frei & recyclebar, Stangenlänge: 2 Meter

Für die ornamentierten Modelle: 2 Meter $\sim \pm 2\%$

Zum Fixieren der Leisten können Sie ADEFIX Kleber und Stahlstifte verwenden - Alle Fugen mit ADEFIX füllen!

Artikel-Nr. article-no.	Farbe colour	VE/Stange unit/piece	Preis/Stange price/piece	
			200 cm Lagerware	200 cm Bestellware
B 710 14x70 mm	weiß/white	70	11,45	
B 715 20x20 mm	weiß/white	180	2,51	
B 717 20x30 mm	weiß/white	150	3,72	
B 720 20x25 mm	weiß/white	155	2,51	
B 725 18x25 mm	weiß/white	200	2,51	
B 732 50x50 mm	weiß/white	70	5,35	
B 734 80x80 mm	weiß/white	70	12,41	

ITALSTYL

Zierprofile aus extrudiertem Polystyrol, FCKW frei & recyclebar, Stangenlänge: 2 Meter

Für die ornamentierten Modelle: 2 Meter $\sim \pm 2\%$

Zum Fixieren der Leisten können Sie ADEFIX Kleber und Stahlstifte verwenden - Alle Fugen mit ADEFIX füllen!

15A

Artikel-Nr. article-no.	Farbe colour	VE/Stange unit/piece	Preis/Stange price/piece	
			200 cm Lagerware	200 cm Bestellware
B 735 35x35 mm	weiß/white	105	4,81	
B 737 20x20 mm	weiß/white	230	2,68	
B 740 30x30 mm	weiß/white	120	4,64	
B 741 30x30 mm	weiß/white	140	3,39	
B 742 30x35 mm	weiß/white	150	4,22	
B 743 40x40 mm	weiß/white	115	4,89	
B 745 17x40 mm	weiß/white	110	5,39	

ITALSTYL

Zierprofile aus extrudiertem Polystyrol, FCKW frei & recyclebar, Stangenlänge: 2 Meter

Für die ornamentierten Modelle: 2 Meter $\sim \pm 2\%$

Zum Fixieren der Leisten können Sie ADEFIX Kleber und Stahlstifte verwenden - Alle Fugen mit ADEFIX füllen!

B 750
50x50 mmArtikel-Nr.
article-no.Farbe
colourVE/Stange
unit/piecePreis/Stange
price/piece**B 750**

weiß/white

65

200 cm Lagerware	200 cm Bestellware
6,90	

B 755
40x50 mmArtikel-Nr.
article-no.Farbe
colourVE/Stange
unit/piecePreis/Stange
price/piece**B 755**

weiß/white

60

200 cm Lagerware	200 cm Bestellware
6,48	

B 758
60x60 mmArtikel-Nr.
article-no.Farbe
colourVE/Stange
unit/piecePreis/Stange
price/piece**B 758**

weiß/white

70

200 cm Lagerware	200 cm Bestellware
9,28	

B 760
40x45 mmArtikel-Nr.
article-no.Farbe
colourVE/Stange
unit/piecePreis/Stange
price/piece**B 760**

weiß/white

65

200 cm Lagerware	200 cm Bestellware
6,90	

B 761
70x70 mmArtikel-Nr.
article-no.Farbe
colourVE/Stange
unit/piecePreis/Stange
price/piece**B 761**

weiß/white

75

200 cm Lagerware	200 cm Bestellware
12,12	

B 763
80x85 mmArtikel-Nr.
article-no.Farbe
colourVE/Stange
unit/piecePreis/Stange
price/piece**B 763**

weiß/white

55

200 cm Lagerware	200 cm Bestellware
13,92	

B 764
100x100 mmArtikel-Nr.
article-no.Farbe
colourVE/Stange
unit/piecePreis/Stange
price/piece**B 764**

weiß/white

36

200 cm Lagerware	200 cm Bestellware
26,00	

ITALSTYL

Zierprofile aus extrudiertem Polystyrol, FCKW frei & recyclebar, Stangenlänge: 2 Meter

Für die ornamentierten Modelle: 2 Meter $\pm 2\%$

Zum Fixieren der Leisten können Sie ADEFIX Kleber und Stahlstifte verwenden - Alle Fugen mit ADEFIX füllen!

15A

Artikel-Nr. article-no.	Farbe colour	VE/Stange unit/piece	Preis/Stange price/piece	
			200 cm Lagerware	200 cm Bestellware
B 765 70x70 mm	weiß/white	65	12,92	
B 766 70x70 mm	weiß/white	105	11,12	
B 767 95x95 mm	weiß/white	55	19,40	
B 770 14x70 mm	weiß/white	65	7,77	
B 773 19x60 mm	weiß/white	60	7,69	
B 774 20x100 mm	weiß/white	80	11,33	
B 775 95x105 mm	weiß/white	45	18,14	

ITALSTYL

Zierprofile aus extrudiertem Polystyrol, FCKW frei & recyclebar, Stangenlänge: 2 Meter

Für die ornamentierten Modelle: 2 Meter $\sim \pm 2\%$

Zum Fixieren der Leisten können Sie ADEFIX Kleber und Stahlstifte verwenden - Alle Fugen mit ADEFIX füllen!

Artikel-Nr. article-no.	Farbe colour	VE/Stange unit/piece	Preis/Stange price/piece	
			200 cm Lagerware	200 cm Bestellware
B 776 100x100 mm	weiß/white	34	26,00	
B 777 105x90 mm	weiß/white	45	19,14	
B 779 100x100 mm	weiß/white	40	27,25	
B 780 80x80 mm	weiß/white	50	15,88	
B 785 70x80 mm	weiß/white	50	15,88	
B 791 110x110 mm	weiß/white	50	20,69	
B 793 130x140 mm	weiß/white	33	29,64	

ITALSTYL

Zierprofile aus extrudiertem Polystyrol, FCKW frei & recyclebar, Stangenlänge: 2 Meter

Für die ornamentierten Modelle: 2 Meter $\sim \pm 2\%$

Zum Fixieren der Leisten können Sie ADEFIX Kleber und Stahlstifte verwenden - Alle Fugen mit ADEFIX füllen!

15A

Artikel-Nr. article-no.	Farbe colour	VE/Stange unit/piece	Preis/Stange price/piece	
			200 cm Lagerware	200 cm Bestellware
B 802	weiß/white	390	1,84	



Artikel-Nr. article-no.	Farbe colour	VE/Stange unit/piece	Preis/Stange price/piece	
			200 cm Lagerware	200 cm Bestellware
B 803	weiß/white	300	2,01	



AMERICANSTYL - Stossleisten für Tür- und Fensterumrahmungen

Zierprofile aus Polistrukturato, FCKW frei & recyclebar, Stangenlänge: 2 Meter

Zum Fixieren der Leisten können Sie ADEFIX Kleber und Stahlstifte verwenden - Alle Fugen mit ADEFIX füllen!

Artikel-Nr. article-no.	Farbe colour	VE/Stange unit/piece	Preis/Stange price/piece	
			200 cm Lagerware	200 cm Bestellware
B A01D	weiß/white	60	15,38	



Artikel-Nr. article-no.	Farbe colour	VE/Stange unit/piece	Preis/Stange price/piece	
			200 cm Lagerware	200 cm Bestellware
B A03D	weiß/white	75	11,20	



Artikel-Nr. article-no.	Farbe colour	VE/Stange unit/piece	Preis/Stange price/piece	
			200 cm Lagerware	200 cm Bestellware
B A10W	weiß/white	30	19,90	



Artikel-Nr. article-no.	Farbe colour	VE/Stange unit/piece	Preis/Stange price/piece	
			200 cm Lagerware	200 cm Bestellware
B A13W	weiß/white	16	35,28	



EUROSTYL

Zierprofile aus extrudiertem Polystyrol, FCKW frei & recyclebar, Stangenlänge: 1,25 Meter

Für die ornamentierten Modelle: $\sim \pm 2\%$

Zum Fixieren der Leisten können Sie ADEFIX Kleber und Stahlstifte verwenden - Alle Fugen mit ADEFIX füllen!

B C2L

13x37 mm

Artikel-Nr.
article-no.Farbe
colourVE/Stange
unit/piecePreis/Stange
price/piece**B C2L**

weiß/white

96

125 cm Lagerware	125 cm Bestellware
4,24	

B C3L

23x65 mm

Artikel-Nr.
article-no.Farbe
colourVE/Stange
unit/piecePreis/Stange
price/piece**B C3L**

weiß/white

48

125 cm Lagerware	125 cm Bestellware
7,19	

B C6L

56x56 mm

Artikel-Nr.
article-no.Farbe
colourVE/Stange
unit/piecePreis/Stange
price/piece**B C6L**

weiß/white

40

125 cm Lagerware	125 cm Bestellware
8,28	

B C7L

80x85 mm

Artikel-Nr.
article-no.Farbe
colourVE/Stange
unit/piecePreis/Stange
price/piece**B C7L**

weiß/white

38

125 cm Lagerware	125 cm Bestellware
15,78	

B C8L

126x126 mm

Artikel-Nr.
article-no.Farbe
colourVE/Stange
unit/piecePreis/Stange
price/piece**B C8L**

weiß/white

26

125 cm Lagerware	125 cm Bestellware
27,76	

B C9L

155x160 mm

Artikel-Nr.
article-no.Farbe
colourVE/Stange
unit/piecePreis/Stange
price/piece**B C9L**

weiß/white

17

125 cm Lagerware	125 cm Bestellware
53,73	

B F4L

145x205 mm

Artikel-Nr.
article-no.Farbe
colourVE/Stange
unit/piecePreis/Stange
price/piece**B F4L**

weiß/white

12

125 cm Lagerware	125 cm Bestellware
64,18	

EUROSTYL

Zierprofile aus extrudiertem Polystyrol, FCKW frei & recyclebar, Stangenlänge: 1,25 Meter

Für die ornamentierten Modelle: $\pm 2\%$

Zum Fixieren der Leisten können Sie ADEFIX Kleber und Stahlstifte verwenden - Alle Fugen mit ADEFIX füllen!

15A

B F5L
53x78 mmArtikel-Nr.
article-no.Farbe
colourVE/Stange
unit/piecePreis/Stange
price/piece**B F5L**

weiß/white

44

125 cm	125 cm
Lagerware	Bestellware
7,19	

B P4L
25x37 mmArtikel-Nr.
article-no.Farbe
colourVE/Stange
unit/piecePreis/Stange
price/piece**B P4L**

weiß/white

80

125 cm	125 cm
Lagerware	Bestellware
5,60	

B P5L
65x80 mmArtikel-Nr.
article-no.Farbe
colourVE/Stange
unit/piecePreis/Stange
price/piece**B P5L**

weiß/white

32

125 cm	125 cm
Lagerware	Bestellware
11,50	

B P9L
165x165 mmArtikel-Nr.
article-no.Farbe
colourVE/Stange
unit/piecePreis/Stange
price/piece**B P9L**

weiß/white

17

125 cm	125 cm
Lagerware	Bestellware
55,87	

B R1L
70x70 mmArtikel-Nr.
article-no.Farbe
colourVE/Stange
unit/piecePreis/Stange
price/piece**B R1L**

weiß/white

28

125 cm	125 cm
Lagerware	Bestellware
11,50	

B W0L
22x80 mmArtikel-Nr.
article-no.Farbe
colourVE/Stange
unit/piecePreis/Stange
price/piece**B W0L**

weiß/white

36

125 cm	125 cm
Lagerware	Bestellware
7,65	

B W1L
22x80 mmArtikel-Nr.
article-no.Farbe
colourVE/Stange
unit/piecePreis/Stange
price/piece**B W1L**

weiß/white

40

125 cm	125 cm
Lagerware	Bestellware
7,65	

EUROSTYL

Zierprofile aus extrudiertem Polystyrol, FCKW frei & recyclebar, Stangenlänge: 1,25 Meter

Für die ornamentierten Modelle: $\sim \pm 2\%$

Zum Fixieren der Leisten können Sie ADEFIX Kleber und Stahlstifte verwenden - Alle Fugen mit ADEFIX füllen!

B W2L

22x80 mm

Artikel-Nr.
article-no.Farbe
colourVE/Stange
unit/piecePreis/Stange
price/piece**B W2L**

weiß/white

40

125 cm Lagerware	125 cm Bestellware
7,65	

B W3L

23x50 mm

Artikel-Nr.
article-no.Farbe
colourVE/Stange
unit/piecePreis/Stange
price/piece**B W3L**

weiß/white

56

125 cm Lagerware	125 cm Bestellware
6,69	

B W4L

18x125 mm

Artikel-Nr.
article-no.Farbe
colourVE/Stange
unit/piecePreis/Stange
price/piece**B W4L**

weiß/white

26

125 cm Lagerware	125 cm Bestellware
15,22	

B Z1L

35x105 mm

Artikel-Nr.
article-no.Farbe
colourVE/Stange
unit/piecePreis/Stange
price/piece**B Z1L**

weiß/white

40

125 cm Lagerware	125 cm Bestellware
14,44	

B Z2L

85x85 mm

Artikel-Nr.
article-no.Farbe
colourVE/Stange
unit/piecePreis/Stange
price/piece**B Z2L**

weiß/white

44

125 cm Lagerware	125 cm Bestellware
16,82	

B Z3L

80x100 mm

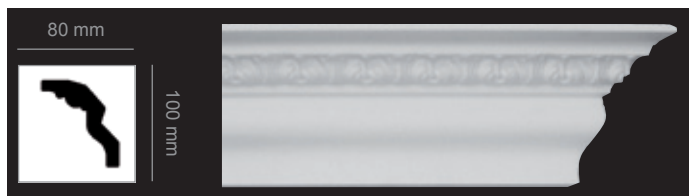
Artikel-Nr.
article-no.Farbe
colourVE/Stange
unit/piecePreis/Stange
price/piece**B Z3L**

weiß/white

36

125 cm Lagerware	125 cm Bestellware
18,04	

B Z4L

127x127 mm

Artikel-Nr.
article-no.Farbe
colourVE/Stange
unit/piecePreis/Stange
price/piece**B Z4L**

weiß/white

24

125 cm Lagerware	125 cm Bestellware
31,31	

EUROSTYL

Zierprofile aus extrudiertem Polystyrol, FCKW frei & recyclebar, Stangenlänge: 1,25 Meter

Für die ornamentierten Modelle: $\sim\pm 2\%$

Zum Fixieren der Leisten können Sie ADEFIX Kleber und Stahlstifte verwenden - Alle Fugen mit ADEFIX füllen!

15A
15C**B Z5L**
128x128 mmArtikel-Nr.
article-no.Farbe
colourVE/Stange
unit/piecePreis/Stange
price/piece**B Z5L**

weiß/white

20

125 cm	125 cm
Lagerware	Bestellware
32,14	

B Z8L
30x60 mmArtikel-Nr.
article-no.Farbe
colourVE/Stange
unit/piecePreis/Stange
price/piece**B Z8L**

weiß/white

48

125 cm	125 cm
Lagerware	Bestellware
6,90	

B Z9L
35x70 mmArtikel-Nr.
article-no.Farbe
colourVE/Stange
unit/piecePreis/Stange
price/piece**B Z9L**

weiß/white

48

125 cm	125 cm
Lagerware	Bestellware
7,52	

ZUBEHÖR

ADEFIX KLEBER 310 mlArtikel-Nr.
article-no.VE
unitPreis/Stück
price/piece**300 NMC**

24

Lagerware	Bestellware
8,67	

SÄGEArtikel-Nr.
article-no.VE
unitPreis/Stück
price/piece**B SÄGE**

1

Lagerware	Bestellware
30,68	

GEHRUNGSLADE

160x200x500 mm

Artikel-Nr.
article-no.VE
unitPreis/Stück
price/piece**B GEHRUNGSLA**

1

Lagerware	Bestellware
69,05	



ROSETTEN

EUROSTYL ROSETTEN

Rosetten aus extrudiertem Polystyrol
FCKW frei & recyclebar
In geschützter DIY-Verpackung

15B

B B1L

150 mm
1 SET=2 Stück

**B B2L**

120 mm
1 SET=2 Stück

**B C00**

65 mm
1 SET=4 Stück

**B B21**

280 mm

**B B24**

340 mm

**B C01**

530x430 mm



Artikel-Nr. article-no.	Farbe colour	VE unit	Preis/Set price/set				
B B1L	weiß/white	1	<table border="1"> <thead> <tr> <th>Lagerware</th> <th>Bestellware</th> </tr> </thead> <tbody> <tr> <td>13,40</td> <td></td> </tr> </tbody> </table>	Lagerware	Bestellware	13,40	
Lagerware	Bestellware						
13,40							

Artikel-Nr. article-no.	Farbe colour	VE unit	Preis/Set price/set				
B B2L	weiß/white	1	<table border="1"> <thead> <tr> <th>Lagerware</th> <th>Bestellware</th> </tr> </thead> <tbody> <tr> <td>12,90</td> <td></td> </tr> </tbody> </table>	Lagerware	Bestellware	12,90	
Lagerware	Bestellware						
12,90							

Artikel-Nr. article-no.	Farbe colour	VE unit	Preis/Set price/set				
B C00	weiß/white	1	<table border="1"> <thead> <tr> <th>Lagerware</th> <th>Bestellware</th> </tr> </thead> <tbody> <tr> <td>12,41</td> <td></td> </tr> </tbody> </table>	Lagerware	Bestellware	12,41	
Lagerware	Bestellware						
12,41							

Artikel-Nr. article-no.	Farbe colour	VE unit	Preis/Stück price/piece				
B B21	weiß/white	1	<table border="1"> <thead> <tr> <th>Lagerware</th> <th>Bestellware</th> </tr> </thead> <tbody> <tr> <td>15,09</td> <td></td> </tr> </tbody> </table>	Lagerware	Bestellware	15,09	
Lagerware	Bestellware						
15,09							

Artikel-Nr. article-no.	Farbe colour	VE unit	Preis/Stück price/piece				
B B24	weiß/white	1	<table border="1"> <thead> <tr> <th>Lagerware</th> <th>Bestellware</th> </tr> </thead> <tbody> <tr> <td>19,63</td> <td></td> </tr> </tbody> </table>	Lagerware	Bestellware	19,63	
Lagerware	Bestellware						
19,63							

Artikel-Nr. article-no.	Farbe colour	VE unit	Preis/Stück price/piece				
B C01	weiß/white	1	<table border="1"> <thead> <tr> <th>Lagerware</th> <th>Bestellware</th> </tr> </thead> <tbody> <tr> <td>28,17</td> <td></td> </tr> </tbody> </table>	Lagerware	Bestellware	28,17	
Lagerware	Bestellware						
28,17							

EUROSTYL ROSETTEN

Rosetten aus extrudiertem Polystyrol
FCKW frei & recyclebar
In geschützter DIY-Verpackung

B C15
410 mm



B C21
240 mm



B C22
330 mm



B C25
440 mm



B C27
660 mm



B C33
470 mm



Artikel-Nr. article-no.	Farbe colour	VE unit	Preis/Stück price/piece
B C15	weiß/white	1	23,62

Lagerware	Bestellware
23,62	

Artikel-Nr. article-no.	Farbe colour	VE unit	Preis/Stück price/piece
B C21	weiß/white	1	15,76

Lagerware	Bestellware
15,76	

Artikel-Nr. article-no.	Farbe colour	VE unit	Preis/Stück price/piece
B C22	weiß/white	1	16,26

Lagerware	Bestellware
16,26	

Artikel-Nr. article-no.	Farbe colour	VE unit	Preis/Stück price/piece
B C25	weiß/white	1	27,59

Lagerware	Bestellware
27,59	

Artikel-Nr. article-no.	Farbe colour	VE unit	Preis/Stück price/piece
B C27	weiß/white	1	48,43

Lagerware	Bestellware
48,43	

Artikel-Nr. article-no.	Farbe colour	VE unit	Preis/Stück price/piece
B C33	weiß/white	1	29,09

Lagerware	Bestellware
29,09	

15B

EUROSTYL ROSETTEN

Rosetten aus extrudiertem Polystyrol
FCKW frei & recyclebar
In geschützter DIY-Verpackung

15B

B M52
450 mm



B R25
250 mm



B R29
290 mm



B R43
430x300 mm



B R51
510 mm



B R55
550 mm



B R64
640 mm



Artikel-Nr. article-no.	Farbe colour	VE unit	Preis/Stück price/piece
B M52	weiß/white	1	29,36

Artikel-Nr. article-no.	Farbe colour	VE unit	Preis/Stück price/piece
B R25	weiß/white	1	15,80

Artikel-Nr. article-no.	Farbe colour	VE unit	Preis/Stück price/piece
B R29	weiß/white	1	18,41

Artikel-Nr. article-no.	Farbe colour	VE unit	Preis/Stück price/piece
B R43	weiß/white	1	24,72

Artikel-Nr. article-no.	Farbe colour	VE unit	Preis/Stück price/piece
B R51	weiß/white	1	38,50

Artikel-Nr. article-no.	Farbe colour	VE unit	Preis/Stück price/piece
B R55	weiß/white	1	44,22

Artikel-Nr. article-no.	Farbe colour	VE unit	Preis/Stück price/piece
B R64	weiß/white	1	49,28

MONTAGEANLEITUNG für Zierprofile

Wir empfehlen Zierprofile & Rosetten nach Möglichkeit vor den Tapeziererarbeiten zu verkleben.

Der Untergrund muss saugfähig, sauber, trocken und staubfrei sein.

Folgende Werkzeuge werden benötigt: Gehrungslade, BOVELACCI Spezialsäge, ADEFIX Kleber, Spachtel, Schwamm, Pinsel, Cuttermesser und ein Zollstock.



Beim Schneiden der Gehrung ist unbedingt darauf zu achten, dass die "Deckenklebefläche" des Zierprofils auf dem Boden und die "Wandklebefläche" an der Innenwand der Gehrungslade liegt.

Nachdem die Gehrung auf Passgenauigkeit geprüft wurde, wird der Klebstoff auf beide Klebeflächen und im Stoßbereich (!) mit der Kartusche oder mit der Spachtel aufgetragen.

Das Zierprofil passgenau ansetzen und vorsichtig andrücken. Alle Fugen und Stöße mit Klebstoff füllen.

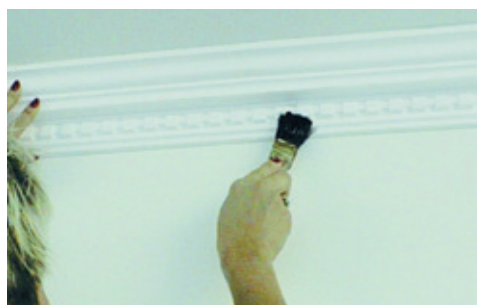

Überschüssigen Klebstoff mit der Spachtel sofort entfernen.

Anschließend Klebstoffreste mit einem feuchten Schwamm sofort abwaschen.

Die Zierprofile können nach einer Trocknungszeit von ca. 24 Stunden mit Dispersionsfarbe oder Acryllack (Acryllack auf Reststück testen) überstrichen werden.

MONTAGEANLEITUNG für Rosetten



Um eine Öffnung für ein Lampenkabel zu erhalten, wird die passende Größe mit einem Cutter herausgeschnitten.

Ausreichend mit ADEFIX Kleber am Rand der Rosette auftragen.

Die Rosette passgenau ansetzen und vorsichtig andrücken. Die umlaufenden Fugen mit ADEFIX Kleber füllen. Nach ausreichender Trocknung des Klebers kann die Rosette gestrichen werden.

NMC-MERX - STUCKPROFILE

nmc | decoration
KATALOG CATALOGUE 2018
www.nmc-decoration.com

*Neuheiten
Nouveautés*
2018

WALLSTYL® WL7

WALLSTYL®

WALLSTYL® FD25 without line

ARSTYL® WALL PANELS
FLOWER

Im Programm - fragen Sie bei uns nach dem aktuellen Katalog!

www.merx.at

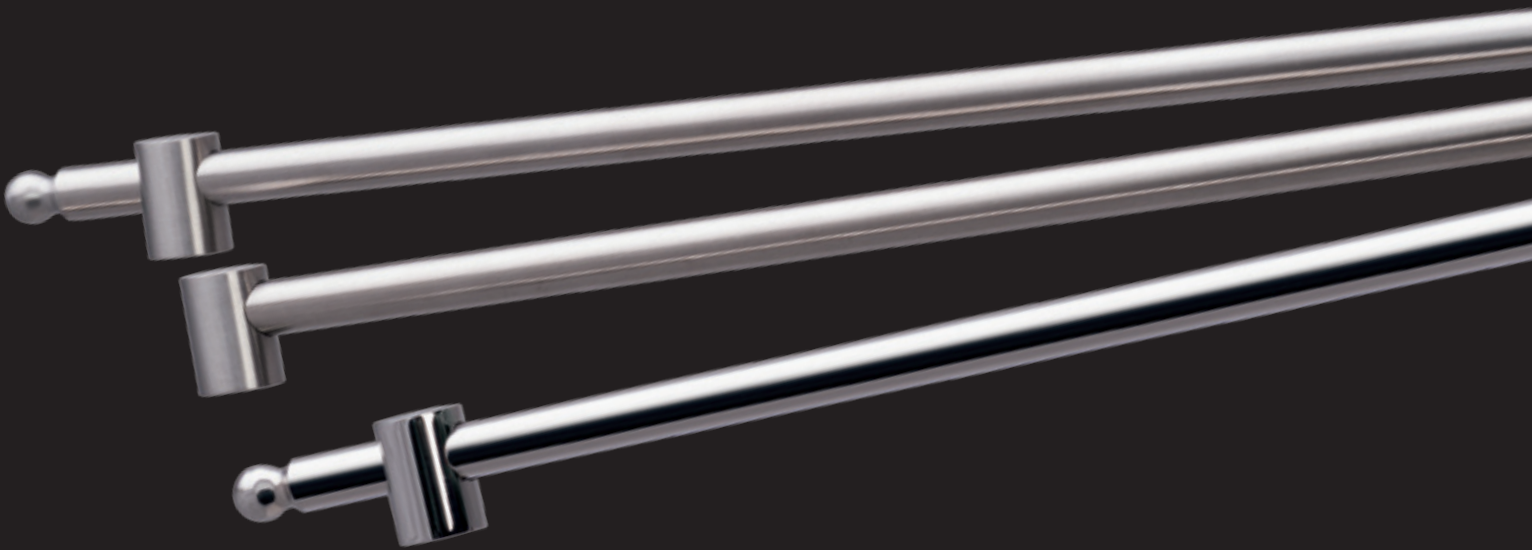

EDELSTAHL TREPPENSTANGEN

INOX STAIR RODS

TREPPENSTANGEN

16A

TREPPENSTANGEN-ROHR 10 mm

Edelstahl gebürstet
Stainless steel brushed



Artikel-Nr. article-no.	Oberfläche surface	Maße size	VE unit	Preis/Stange price/piece
11900 70 116	Edelstahl gebürstet	70 cm	1	12,60
11900 80 116	Edelstahl gebürstet	80 cm	1	14,40
11900 90 116	Edelstahl gebürstet	90 cm	1	16,20
11900 100116	Edelstahl gebürstet	100 cm	1	18,00

Sonderlängen auf Anfrage

TREPPENSTANGEN-ROHR 10 mm

Edelstahl poliert
Stainless steel polished



Artikel-Nr. article-no.	Oberfläche surface	Maße size	VE unit	Preis/Stange price/piece
11900 70 126	Edelstahl poliert	70 cm	1	25,20
11900 80 126	Edelstahl poliert	80 cm	1	28,80
11900 90 126	Edelstahl poliert	90 cm	1	32,40
11900 100126	Edelstahl poliert	100 cm	1	36,00

Sonderlängen auf Anfrage

TREPPENSTANGEN-ROHR 10 mm inklusive Endstücke

Edelstahl gebürstet



Artikel-Nr. article-no.	Oberfläche surface	Maße size	VE unit	Preis/Stange price/piece
11905 70 116	Edelstahl gebürstet	70 cm	1	17,50
11905 80 116	Edelstahl gebürstet	80 cm	1	20,00
11905 90 116	Edelstahl gebürstet	90 cm	1	22,50
11905 100116	Edelstahl gebürstet	100 cm	1	25,00

Sonderlängen auf Anfrage

TREPPENSTANGEN-ROHR 10 mm inklusive Endstücke

Edelstahl poliert



Artikel-Nr. article-no.	Oberfläche surface	Maße size	VE unit	Preis/Stange price/piece
11905 70 126	Edelstahl poliert	70 cm	1	31,50
11905 80 126	Edelstahl poliert	80 cm	1	36,00
11905 90 126	Edelstahl poliert	90 cm	1	40,50
11905 100126	Edelstahl poliert	100 cm	1	45,00

Sonderlängen auf Anfrage

Lieferzeit 2-3 Wochen / delivery time 2-3 weeks

TREPPENSTANGENÖSEN

ÖSE für 10 mm TREPPENSTANGE



Artikel-Nr. article-no.	Farbe colour	Maße size	VE unit	Preis/Stück price/piece	
				Lagerware	Bestellware
2101 10 30	nickel matt	10 mm	1		2,20
2101 10 02	nickel poliert	10 mm	1		1,60

16A

ÖSE für 10 mm TREPPENSTANGE

seitlich geschlossen



Artikel-Nr. article-no.	Farbe colour	Maße size	VE unit	Preis/Stück price/piece	
				Lagerware	Bestellware
21016 10 116	Edelstahl gebürstet	10 mm	1		16,00
21016 10 126	Edelstahl poliert	10 mm	1		19,00

ÖSE für 10 mm TREPPENSTANGE

seitlich offen

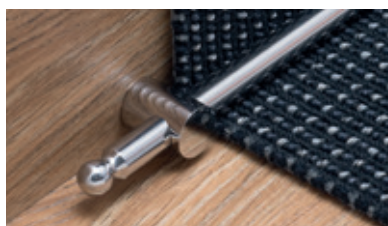

Artikel-Nr. article-no.	Farbe colour	Maße size	VE unit	Preis/Stück price/piece	
				Lagerware	Bestellware
21020 10 116	Edelstahl gebürstet	10 mm	1		16,00
21020 10 126	Edelstahl poliert	10 mm	1		19,00

Lieferzeit 2-3 Wochen / delivery time 2-3 weeks



TREPPENSTANGEN

STAIR RODS

TREPPENSTANGEN

16B

TREPPENSTANGEN-ROHR rund 5 lfm



Artikel-Nr. article-no.	Farbe colour	Maße size	VE unit	Preis/Stange price/piece 500 cm	Preis/Stange price/piece 500 cm
209	L	Messingrohr, messing glanz	9 mm	1	56,45
513	L	Stahlrohr, chrom glanz ummantelt	13 mm	1	102,00
13	L	Stahlrohr, messing glanz ummantelt	13 mm	1	86,65
2016 LACK	L	Messingrohr, messing glanz	16 mm	1	126,05
160 MS	L	Stahlrohr, messing glanz ummantelt	16 mm	1	82,25
516	L	Messingrohr, chrom glanz ummantelt	16 mm	1	175,35

Lagerware	Bestellware
	Zuschnitt + 20%

TREPPENSTANGEN-ROHR rund Nur ZUSCHNITT



Artikel-Nr. article-no.	Farbe colour	Maße size	VE unit	Preis/lfm price/m 100 cm	Preis/lfm price/m 100 cm
801 16 21		Stahlrohr, nickel glanz ummantelt	16 mm	1	35,53
801 16 29		Stahlrohr, nickel matt ummantelt	16 mm	1	35,51
800 16 29		Messingrohr, nickel matt ummantelt	16 mm	1	45,60

Lagerware	Bestellware
	Zuschnitt + 20%

TREPPENSTANGEN-ROHR dreikant 5 lfm



Artikel-Nr. article-no.	Farbe colour	Maße size	VE unit	Preis/Stange price/piece 500 cm	Preis/Stange price/piece 500 cm
16	L	Stahlrohr, messing ummantelt	16x16 mm	1	132,60
260	L	Stahlrohr, chrom ummantelt	16x16 mm	1	172,65

Lagerware	Bestellware
	Zuschnitt + 20%

TREPPENSTANGEN-ROHR dreikant Nur ZUSCHNITT



Artikel-Nr. article-no.	Farbe colour	Maße size	VE unit	Preis/lfm price/m 100 cm	Preis/lfm price/m 100 cm
807 21		Stahlrohr, nickel glanz ummantelt	16x16 mm	1	48,00
807 29		Stahlrohr, nickel matt ummantelt	16x16 mm	1	60,00

Lagerware	Bestellware
	Zuschnitt + 20%

TREPPENSTANGENÖSEN und KLOBEN

ÖSE für TREPPENSTANGE

ÖSE 13 mm: H: ca. 27mm / Schraube 25 mm
ÖSE 9 mm: H: ca. 22 mm / Schraube 20 mm



Artikel-Nr. article-no.	Farbe colour	Maße size	VE unit	Preis/Stück price/piece
2101 09 01		messing poliert, unlackiert	9 mm	1
2101 13 01		messing poliert, unlackiert	13 mm	1
2101 13 22		messing verchromt glanz	13 mm	1

Lagerware	Bestellware
	Zuschnitt + 20%

KLOBEN für TREPPENSTANGE

geschlossen für Rund- und Dreikantröhre

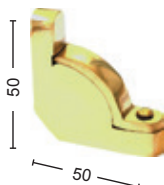

Artikel-Nr. article-no.	Farbe colour	Maße size	VE unit	Preis/Stück price/piece
2106 13 23		messing glanz	13 mm	2
2109 16 21		messing nickel glanz	16 mm	2
2109 16 23		messing glanz, lackiert	16 mm	2
2109 16 29		messing nickel matt	16 mm	2

Lagerware	Bestellware
	Zuschnitt + 20%

KLOBEN für TREPPENSTANGE

geschlossen, Bohrung, für Rund- und Dreikantröhre

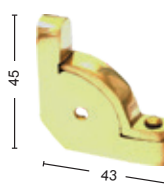

Artikel-Nr. article-no.	Farbe colour	Maße size	VE unit	Preis/Stück price/piece
21091 16 21		messing nickel glanz	16 mm	2
21091 16 23		messing glanz, lackiert	16 mm	2
21091 16 29		messing nickel matt	16 mm	2

Lagerware	Bestellware
	Zuschnitt + 20%

KLOBEN für TREPPENSTANGE

offen, für Rundrohr

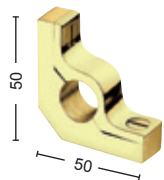

Artikel-Nr. article-no.	Farbe colour	Maße size	VE unit	Preis/Stück price/piece
21231 16 23		messing glanz, lackiert	16 mm	1

Lagerware	Bestellware
	Zuschnitt + 20%

TREPPENSTANGEN-SICHERUNG

TREPPENSTANGEN-SICHERUNG

für 13 mm Rohr



Artikel-Nr. article-no.	Farbe colour	Maße size	VE unit	Preis/Stück price/piece
630 20 13	messing poliert		1	4,37

ENDKNÖPFE ZU TREPPENSTANGEN

ENDKNOPF mit FEDER (Dübel)

für 9 mm und 13 mm Rohr



Artikel-Nr. article-no.	Farbe colour	Maße size	VE unit	Preis/Stück price/piece
620 09 20	messing poliert	9 mm	1	3,78
620 13 20	messing poliert	13 mm	1	6,10
620 13 21	messing vernickelt	13 mm	1	7,02

ENDKNOPF für TREPPENSTANGEN

ohne Fixiergummi

H: ca. 16 mm L: ca. 33 mm



Artikel-Nr. article-no.	Farbe colour	Maße size	VE unit	Preis/Stück price/piece
210901 21	messing nickel glanz		1	13,50
210901 23	messing glanz lackiert		1	13,50
210901 29	messing nickel matt		1	16,00

ENDKNOPF für TREPPENSTANGEN

mit Fixiergummi, für 16 mm Rundrohre



Artikel-Nr. article-no.	Farbe colour	Maße size	VE unit	Preis/Stück price/piece
2109011 21	messing nickel glanz	16 mm	1	16,50
2109011 23	messing glanz lackiert	16 mm	1	16,50
2109011 29	messing nickel matt	16 mm	1	19,00

ENDKNOPF für TREPPENSTANGEN

mit Stockschraube und Dübel, für 13 mm Rundrohre



Artikel-Nr. article-no.	Farbe colour	Maße size	VE unit	Preis/Stück price/piece
2109012 21	messing nickel glanz	13 mm	1	16,50
2109012 23	messing glanz lackiert	13 mm	1	16,50
2109012 29	messing nickel matt	13 mm	1	19,00

TEPPICHNÄGEL

TEPPICHNÄGEL

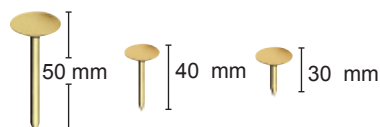

Artikel-Nr. article-no.	Farbe colour	Maße size	VE/Karton unit	Preis/Stück price/piece
MS 25101 01	vermessingt	30 mm	100	0,50
MS 25102	vermessingt	40 mm	100	0,54
MS 25103	vermessingt	50 mm	100	0,61



**SEILBESCHLÄGE
SEILE**

***ROPE FITTINGS
ROPES***

SEILBESCHLÄGE

Seilbeschläge sind nur für Dekorationszwecke bestimmt und eignen sich nicht für große Belastungen, wie z.B. als Handlauf!

16C

MITTELTRÄGER für 30 mm Seil mit Stockschraube



Artikel-Nr. article-no.	Farbe colour	Maße size	VE unit	Preis/Stück price/piece
31030 22	messing verchromt		1	
31030 23	messing poliert lackiert		1	

Lagerware	Bestellware
15,34	
13,15	

MITTELTRÄGER für 30 mm Seil mit zwei Schraublöchern



Artikel-Nr. article-no.	Farbe colour	Maße size	VE unit	Preis/Stück price/piece
31130 22	messing verchromt		1	
31130 23	messing poliert lackiert		1	

Lagerware	Bestellware
16,45	
17,54	

ENDHALTER mit RING für 30 mm Seil



Artikel-Nr. article-no.	Farbe colour	Maße size	VE unit	Preis/Stück price/piece
33030 22	messing verchromt		1	
33030 23	messing poliert lackiert		1	

Lagerware	Bestellware
13,15	
10,97	

ENDHALTER ohne RING für 30 mm Seil



Artikel-Nr. article-no.	Farbe colour	Maße size	VE unit	Preis/Stück price/piece
33130 22	messing verchromt		1	
33130 23	messing poliert lackiert		1	

Lagerware	Bestellware
14,25	
9,86	

AUFHÄNGEHAKEN für 30 mm Seil



Artikel-Nr. article-no.	Farbe colour	Maße size	VE unit	Preis/Stück price/piece
33701 22	messing verchromt		1	
33701 23	messing poliert lackiert		1	

Lagerware	Bestellware
8,78	
6,58	

SEILENDHALTER für 30 mm Seil mit Einhängehaken



Artikel-Nr. article-no.	Farbe colour	Maße size	VE unit	Preis/Stück price/piece
7113 30 22	messing verchromt		1	
7113 30 23	messing poliert lackiert		1	

Lagerware	Bestellware
	24,12
	17,54

STRAPAZSEIL

Sind nur für Dekorationszwecke bestimmt und eignen sich nicht für große Belastungen, wie z.B. als Handlauf!

STRAPAZSEIL



Artikel-Nr.
article-no.

Farbe
colour

Maße
size

VE
unit

Preis/lfm
price/m

3330 BRAUN

braun/brown

28 mm

100 m

26,21

3330 GRÜN

grün/green

28 mm

100 m

26,21

3330 NATUR

natur/natural

28 mm

100 m

26,21

3330 ROT

rot/red

28 mm

100 m

26,21

Strapazseil mit Kabelschlagdrehung, Viskose

Stärke: ca. 28 mm

Farben: natur, braun, rot, grün

Rollenlänge: + 100 lfm, **Metrage + 10%**

ACHTUNG!

Bei der Montage ist das Seil gut festzudrehen
und an den Enden abzubinden!
Montageanleitung wird mitgeliefert.

FARBKARTE
COLOUR CARD

braun
brown



grün
green



natur
natural



rot
red



BÜSCHE PRODUKTE - KARNIESEN

BÜSCHE



Bestellung möglich 2-3 Wochen Lieferzeit

www.buesche.de



**MODULE
KOFFER**

MODULE

17

Symbolfoto



für
270 cm
Profile

MODUL 1: nur für (only for) 270 cm
Breite / width : 100 cm oder 125 cm
Höhe / height : ca. 270 cm
Tiefe / depth : ca. 60 cm
Sockel / base : ca. 20 cm

Symbolfoto



Fahnenständer mit Musterverlegung/
Display with samples

für
270 cm
Profile

6-7 cm

für
100 cm
Profile

15 cm

MODUL 2: für (for) 100 cm und (and) 270 cm
Breite / width : 100 cm oder 125 cm
Höhe / height : ca. 400 cm
Tiefe / depth : ca. 60 cm
Sockel / base : ca. 20 cm

DIVERSE MUSTERKOLLEKTIONEN
Aluprofile, PVC und Holzsockelleisten

Various sample collections
alu profiles, PVC and wooden skirtings



KOFFER mit 7 cm Mustern von Standard und Systemprofilen
Case with 7 cm samples of standard and system profiles



ARTIKELNUMMER	SEITE
100 SL	211
100484	186
100486	186
100488	186
100490	186
101	38
101 R (3565039)	245
101000	186
1010102	50
1012212 R (3566496)	238
1012808 R (3566497)	239
101720	186
101730	186
1018001 R (3566499)	239
101925	186
101940	186
1020102	50
1022208 R (3566106)	239
1023004 R (3566481)	238
1023804 R (3566127)	239
1024004 R (3566482)	238
1025004 R (3566483)	238
1035SK	146
10387	208
104 R (3565040)	245
105 A	32
105 A HD	120
105 A SKL	33
105 A UNGB	32
105 A X	32
105 B	33
105 B SKL	33
105 B UNGB	33
105 B X	33
105 C	34
105 C SKL	34
105 C UNGB	34
105 R (3565041)	245
10510	210
10560	200
10575	201
106 R (3565042)	245
10650Q	198
10655Q	198
107 R (3565043)	245
107150	186
108 A	49
108 B	49
108 C	49
108 D	40
108 E	40
108 F	58
108 G	58
108 I	58
108 J	58

ARTIKELNUMMER	SEITE
108 K	49
108 M	41
108 P	41
108 R (3565044)	245
109	39
109 21	39
109 26	39
109 30	39
109 3A	39
109 3B	39
109 55	40
109606	186
109608	186
109610	186
109612	186
110 A	36
110 B	36
110 R (3565045)	245
1103	36
1105 A	32
1105 A SKL	32
1105 A UNG	32
11055	46
11070	46
11080	46
111	42
111 A	42
111 B	42
111 C	42
11100	46
111006	186
111008	186
111010	186
111012	186
11110	46
11120	46
11130	47
11140	47
11150	47
1118 6-12 AE	118
1118 6-12 IE	118
11180	47
112	41
1121 C 8-12	118
11220	47
113	41
113 A	41
113 B	41
113 C	42
113 D	42
113430	275
114 S	48
115	48
115 A	49
115 B	49

ARTIKELNUMMER	SEITE
116100	192
117 R (3565047)	245
118 6-12	108
119 10	82
119 10 E	106
119 11	83
119 11 E	106
119 12	83
119 12 E	106
119 15	83
119 15 E	106
119 18	83
119 18 E	106
119 2	82
119 2,5	82
119 20	83
119 22	83
119 22 E	106
119 3	82
119 3 E	106
119 4,5	82
119 4,5 E	106
119 6	82
119 6 E	106
119 8	82
119 8 E	106
11900 70-100	266
11905 70-100	266
12	75
12/3 STP	76
120 120 xxx	229
120 150 xxx	229
120 200 xxx	228
12070	52
12080	52
121 10	87
121 12	87
121 A 10	87
121 A 12	87
121 B 10	87
121 B 12	87
121 C 8-12	107
12110	52
1212122	50
12140	52
12150	52
1218	72
122 11	84
122 6	84
122 8	84
1225	75
123 25	68
123 40	68
123 CO 25	103
123 CO 30	103

ARTIKELNUMMER	SEITE
123 CO 40	103
126 R (3567011)	233
127901	176
13	270
1340 10	88
1340 12	88
1340 3	64
1340 4	64
1340 5,5	64
1340 8	88
13514	53
13514 A	53
13515	102
13520	53
13525	102
13526	53
136 CP 8	58
136 CP 8 E	103
136 CP 8 U	58
137100000	182
137100200	182
137100400	182
137100600	182
137100800	182
138351	192
138352	192
138600	192
140203	192
140205	192
140208	192
1407	53
141570000	176
141610000	176
15070	43
15080	43
15110	43
151200 25	152
151200 35	152
151206 25	152
151206 35	152
15150	43
1515152	50
1519	72
1520152	50
16	270
160 MS	270
16070	48
160800	192
160801	192
16100	48
16120	48
18 R (3566423)	241
185300	193
18888 00	196
19 R (3566424)	241

PRODUKTÜBERSICHT - INDEX

ARTIKELNUMMER	SEITE	ARTIKELNUMMER	SEITE	ARTIKELNUMMER	SEITE	ARTIKELNUMMER	SEITE
1990	218	2109011	271	235031120	173	31130	274
1992 15 R (3563347)	233	2109012	271	243451800	188	311302	178
20 R 01 (3566411)	241	21091 16	270	243452800	188	311305	178
20 R 07 (3566412)	241	211 R (3565022)	245	250	75	311402	178
20000	218	21231 16	270	25101	271	311405	178
2006 R 01 (3565235)	243	217 11	86	25102	271	31155	124
2006 R 07 (3565240)	243	217 13	86	25103	271	3119 10	98
201	60	217 7	86	2525	216	3119 12	98
201 10	62	217 7	86	25251	216	3119 15	98
201 10 HD	120	217 9	86	25252	68	3119 3	98
201 10 SKL	62	217 E 7-13	100	2525252	50	3119 4,5	98
201 10 UNGB	62	217 R (3565023)	245	25482	208	3119 6	98
201 15	63	218 10	85	25560	199	3119 8	98
201 15 SKL	63	218 12,5	85	25560	204	31270	123
201 15 UNGB	63	218 6	85	25669	205	314 AE	126
201 22 S	63	218 8	85	260	270	314 E LI	126
201 22 SKL	63	218 E 6-10	100	27 E	76	314 E RE	126
201 22 UNGB	63	2202	61	28	148	314 IE	126
201 R (3565014)	245	2202 SKL	61	300 NMC	258	314 VB	126
201 SKL	60	2202 UNGB	61	301	54	314000	180
201 UNGB	60	2206 R 01 (3565265)	243	301 A	54	314002	180
201 X	60	2206 R 07 (3565269)	243	301 A GEB	54	314201	180
20102	68	221022024	172	301 A SKL	54	314208	180
20114	75	221022036	172	301 X	54	316 AE	126
2015201	50	221022040	172	30152	68	316 E LI	126
2016 LACK	270	221022060	172	30202	69	316 E RE	126
2017201	50	221022080	172	3020302	50	316 IE	126
202 S	62	221022100	172	302F	123	316 VB	126
202 SKL	62	221022120	172	303	55	31610	122
202 UNGB	62	221050024	172	30302	69	31640	122
20202	68	221050036	172	3030303	50	31660	122
2020202	50	221050040	172	304	55	31680	122
202F	123	221050060	172	304 GEB	55	318 AE	126
2030202	50	221050080	172	3050303	50	318 E LI	126
20399 1111	218	221050100	172	306	66	318 E RE	126
204 R (3565015)	245	221050120	172	307	66	318 IE	126
2040202	50	2222 R 01 (3566670)	242	310 AE	126	318 VB	126
205 R (3565016)	245	2230 R 01 (3566631)	242	310 E LI	126	319205	193
206 A	66	2230 R 06 (3566636)	242	310 E RE	126	31960	124
206 R (3565018)	245	2232 R 01 (3566667)	242	310 IE	126	31965	124
207 R (3565019)	245	2232 R 06 (3566668)	242	310 VB	126	33030	274
208 A	66	2240 R 01 (3566630)	242	31005	124	33130	274
208 R (3565020)	245	2240 R 06 (3566635)	242	3101	36	3330	275
209	270	225	75	3101 UNGB	36	335 AE	127
210 R (3565021)	245	2260 R 01 (3566602)	242	3102	37	335 E LI	127
2101 09	270	2260 R 06 (3566606)	242	3102 GEB	37	335 E RE	127
2101 10	267	2260 R 07 (3566611)	242	3103	38	335 IE	127
2101 13	270	230 R (3565025)	245	3103 UNGB	38	335 VB	127
21016 10	267	2332SK	146	31030	274	33650	122
21020 10	267	235031024	173	3105	37	33670	122
2106 13	270	235031036	173	3105 UNGB	37	337 AE	127
2108 R 01 (3565254)	243	235031040	173	3106	38	337 E LI	127
2108 R 07 (3565255)	243	235031060	173	3107	38	337 E RE	127
2109 16	270	235031080	173	3108	37	337 IE	127
210901	271	235031100	173	3108 UNGB	37	337 VB	127

ARTIKELNUMMER	SEITE
33701	274
341690000	179
3515 DL	34
3566287	242
361004103	177
361004105	177
361004195	176
361004503	177
361004808	178
361004913	178
37 R 00 (3566683)	241
37 R 01 (3566680)	241
37 R 06 (3566681)	241
37 R 07 (3566682)	241
38675	152
38813	152
38815	152
38873	152
38875	152
3960 AE	128
3960 E LI	128
3960 E RE	128
3960 IE	128
3960 VB	128
40 K BRAUN	244
40 K WEISS	244
40 STP	76
4000 PG	228
400017	187
400018	187
400019	187
400020	187
400021	187
400022	187
400024	187
400025	187
400028	187
400029	187
400030	187
400031	187
400032	187
400033	187
400037	187
400038	187
400048	187
400056	187
400084	187
400086	187
400118	188
400128	188
400211	189
400212	189
400221	189
400222	189
400223	189

ARTIKELNUMMER	SEITE
400225	189
400231	189
400232	189
400233	189
400248	189
400311	189
400312	189
400313	189
400315	189
400321	189
400322	189
400323	189
400330	189
400331	189
400332	189
40202	69
4020402	50
4022	148
40252	218
402F	123
4040	216
40401	216
40402	69
4040402	50
409601	179
409613	179
41 R (3565305)	244
4100	226
411000	177
411200	177
411400	177
412010	176
412110	176
418700	193
418843	193
42 R (3565306)	244
437120	194
437140	194
441206	173
441208	173
441210	173
441212	173
441215	173
441218	173
441220	182
441225	182
441230	182
441235	182
441240	182
441410	173
441412	173
441416	173
441424	173
441440	173
441460	173

ARTIKELNUMMER	SEITE
441480	173
441502	193
4500 R (3563056)	235
4501 R (3563049)	234
45423	218
4545 R (3563345)	235
46 R 00 (3565341)	244
46 R 01 (3565342)	244
46 R 07 (3565343)	244
4600	226
47450	224
47738 R (3563014)	232
47750 R (3563015)	232
50 SL	210
50 ST	76
501 38	64
5010	245
501050 R (3563189)	232
50132	123
50202	69
5020502	50
502550 R (3563190)	232
503 20	56
503 30	56
503 40	57
503 40 HD	120
503 50	57
50502	69
50550 R (3563191)	232
513	270
516	270
52550 R (3563195)	232
5360 38MM	226
5360 50MM	226
5820	148
59 R 01 (3566331)	237
59 R 07 (3566371)	237
5905 R 01 (3566332)	237
5905 R 07 (3566372)	237
5920 R 01 (3566333)	237
5920 R 07 (3566373)	237
60 R 01 (3566330)	237
60 R 07 (3566370)	237
602	123
60202	69
6022	148
620 09	271
620 13	271
630 20	271
638	55
638 GEB	55
638 SKL	55
644100000	180
650 SB	246
6500 4650	223

ARTIKELNUMMER	SEITE
651 SB	246
66448	72
6650 4050	222
6650 5050	222
6650 7050	222
6650 8550	222
6650 R 00 (3563334)	235
6650 R 07 (3563333)	235
6661	50
6700 4525	221
6801 3550	222
6900 5050	223
6900 9050	223
69191 R (3563085)	234
70 SL	211
703 A	38
7062008 R (3566064)	236
7062016 R (3566043)	236
7062216 R (3566001)	236
7062809 R (3566022)	236
7063504 R (3566023)	236
7068001 R (3566065)	236
71 R (3566201)	240
71 R 07 (3566210)	240
7113 30	274
7116 R 01 (3566202)	240
7116 R 07 (3566211)	240
72 R (3566204)	240
72 R 07 (3566213)	240
72642	224
73 R (3566207)	240
73 R 07 (3566216)	240
73110 24-120	172
73310 36-150	173
73340 36-150	173
74 R 01 (3566300)	237
74 R 07 (3566340)	237
75 R 01 (3566300)	237
75 R 07 (3566340)	237
76 R 01 (3566302)	237
76 R 07 (3566342)	237
768 R (3566147)	240
77	221
77 R 01 (3566306)	237
77 R 07 (3566346)	237
78 R 01 (3566320)	237
78 R 07 (3566360)	237
79 R 01 (3566326)	237
79 R 07 (3566366)	237
79-010121	78
79-010122	78
79-10050	79
79-110850	78
79-110851	78
79-120803	78

PRODUKTÜBERSICHT - INDEX

ARTIKELNUMMER	SEITE
79-120850	78
79-120851	78
79-13250	78
79-132501	78
79-D653SA	79
79-D653SI	79
79-D654SA	79
79-D654SI	79
79-D656SA	79
79-D656SI	79
79-D675SA	79
79-D675SI	79
7900 5025	221
79175	28
79177	28
79179	28
79876 R 01 (3566376)	237
80	148
80 R 01 (3566327)	237
80 R 07 (3566367)	237
800 16	270
801 16	270
801 38	64
801 38 UNGB	64
802	123
803 30	56
803 30 UNG	56
803 40	57
803 40 UNG	57
803 50	57
803 50 UNG	57
807 21	270
807 29	270
850150	183
8881	50
8950 R (3563294)	233
903 30 GEB	102
903 30 SKL	102
903 30 UNG	102
903 40 GEB	103
903 40 SKL	103
903 40 UNG	103
9031 30	102
91 R (3566250)	240
92 R (3566251)	240
93 R (3566252)	240
9900	15
A 119	136
A 144	136
A 169	136
A 194	136
A 69	136
A30158	194
A79125	18
A79127	18

ARTIKELNUMMER	SEITE
A79129	18
ACRYL D	228
AQUA3/200	158
AQUAGRÜN 2	158
AW1410	142
AW1412	142
AW1480	142
AW1910	140
AW1912	140
AW1960	140
AW1980	140
B 701	248
B 702	248
B 703	248
B 705	248
B 706	248
B 707	248
B 709	248
B 710	249
B 715	249
B 717	249
B 720	249
B 725	249
B 732	249
B 734	249
B 735	250
B 737	250
B 740	250
B 741	250
B 742	250
B 743	250
B 745	250
B 750	251
B 755	251
B 758	251
B 760	251
B 761	251
B 763	251
B 764	251
B 765	252
B 766	252
B 767	252
B 770	252
B 773	252
B 774	252
B 775	252
B 776	253
B 777	253
B 779	253
B 780	253
B 785	253
B 791	253
B 793	253
B 802	254
B 803	254

ARTIKELNUMMER	SEITE
B A01D	254
B A03D	254
B A10W	254
B A13W	254
B B1L	260
B B21	260
B B24	260
B B2L	260
B C00	260
B C01	260
B C15	261
B C21	261
B C22	261
B C25	261
B C27	261
B C2L	255
B C33	261
B C3L	255
B C6L	255
B C7L	255
B C8L	255
B C9L	255
B F4L	255
B F5L	256
B GEHRUNGSLA	258
B KERBSTANZE	201
B M52	262
B P4L	256
B P5L	256
B P9L	256
B R1L	256
B R25	262
B R29	262
B R43	262
B R51	262
B R55	262
B R64	262
B SÄGE	258
B W0L	256
B W1L	256
B W2L	257
B W3L	257
B W4L	257
B Z1L	257
B Z2L	257
B Z3L	257
B Z4L	257
B Z5L	258
B Z8L	258
B Z9L	258
BAUFOL2/200	164
BÜROMAT	166
CFG221	30
CFG230	30
CFG233	30

ARTIKELNUMMER	SEITE
CFG625	30
CLIPSTAR	141
D 119	138
D 144	138
D 169	138
D 194	138
D 69	138
DÄMMBAND	146
DF119 10 E	110
DF119 10 R	90
DF119 12 E	111
DF119 12 R	90
DF119 15 E	111
DF119 15 R	91
DF119 18 E	111
DF119 18 R	91
DF119 20 E	111
DF119 20 R	91
DF119 3 E	110
DF119 3 R	90
DF119 4,5 E	110
DF119 4,5 R	90
DF119 6 E	110
DF119 6 R	90
DF119 8 E	110
DF119 8 R	90
DF603	91
DF604	91
DFE 10 RAL	115
DFE 12 RAL	115
DFE 15 RAL	115
DFE 18 RAL	115
DFE 2 RAL	114
DFE 20 RAL	115
DFE 3 RAL	114
DFE 4,5 RAL	114
DFE 6 RAL	114
DFE 8 RAL	114
DFR 10 RAL	95
DFR 12 RAL	95
DFR 15 RAL	95
DFR 18 RAL	95
DFR 2,2 RAL	94
DFR 2,5 RAL	94
DFR 2,8 RAL	94
DFR 20 RAL	95
DFR 3 RAL	94
DFR 4,5 RAL	94
DFR 6 RAL	94
DFR 8 RAL	95
DL 810	76
E 119	134
E 144	134
E 169	134
E 194	134

ARTIKELNUMMER	SEITE
E 69	133
F8934130	183
F8934140	183
F8934150	183
F8934160	183
F8938730	183
F8938740	183
F8938750	183
F8938760	183
G 119	135
G 144	135
G 169	135
G 194	135
G 69	135
GETRA 325	194
GW BASIC	156
GW BASIC ALU	156
GW LVT BASIC	154
GW LVT GRIP	154
GW PROF	155
GW PROF ALU	155
HZ163	150
HZ164	150
HZ165	150
HZ183	150
HZ184	150
HZ185	150
HZ2010	150
HZ2011	150
HZ2012	150
HZ2013	150
HZ2014	150
HZ2015	150
HZ2020	150
HZ2021	150
HZ2022	150
HZ2023	150
HZ2024	150
HZ2025	150
HZ2030	150
HZ2031	150
HZ2032	150
HZ2060	150
HZ2061	150
HZ2062	150
HZ2080	150
HZ2081	150
HZ2082	150
HZ2150 D	150
HZ2151 D	150
HZ2152 D	150
HZ4133	150
HZ4134	150
HZ4135	150
IW25253	40

ARTIKELNUMMER	SEITE
IW25255	40
KOMFORT ROLLE	164
KOMFORT ZUSCHNITT	164
LA2600	15
LIFT 02	18
LINOMUR 45	224
LINOMUR 90	224
LP9600	15
MK37	224
MO1214	142
MO4016	144
MO5816	144
MO6014	142
MO6019	141
MO8014	142
MO8019	141
MO9514	142
MS 110	196
MS 115	196
MS 200	196
MS BAU	196
OLFA CUTTER	180
PA-VLIES 220	164
PAFUDIMA	230
PEP 210P	161
PLANUS 1025	220
POLYGRIP1000-5000	168
POLYMAT 100-701	167
R 119	133
R 144	133
R 169	133
R 194	133
R 69	133
RE 119	137
RE 144	137
RE 169	137
RE 194	137
RE 69	137
REMUR 45	223
REMUR 55	223
REMUR 95	223
RT5960	196
SANI 11	86
SIGAN 1	220
SIGAN 2	220
SIGAN 3	220
SIGAN E	221
SIGAN E PLUS	221
SL1035	146
SL2332	146
SL4018	148
SOFTFLEX 10	160
SOFTFLEX 225	161
SOFTFLEX 25	160
STEAMBRAKE	162

ARTIKELNUMMER	SEITE
STEPTEC 150	224
STEPTEC 220	224
STS21	20
STS21A	21
STS33	20
STS33A	21
STS44	20
STS44A	21
TER S E	170
TER S K	170
TER SOL	170
TF520	24
TF52A	25
TF530	24
TF53A	25
TF540	24
TF54A	25
TF550	24
TF55A	25
TGX100	12
TGX10A	13
TGX200	12
TGX20A	13
TGX233	14
TGX23A	14
TGX300	12
TGX30A	13
TIM 70 AE	129
TIM 70 E	129
TIM 70 IE	129
WL50 LIFE	214
X990	13

Allgemeine Geschäftsbedingungen (AGB) der KÜGELE Profile GmbH - im folgenden KÜGELE genannt:

1. Geltungsbereich:

Diese Allgemeinen Geschäftsbedingungen (AGB) finden Anwendung auf alle Rechtsgeschäfte, die zwischen KÜGELE und Kunden bzw. Lieferanten geschlossen werden und regeln die Erbringung und Durchführung aller derzeitigen und künftigen Leistungen und Lieferungen zwischen den Vertragsparteien. KÜGELE liefert und leistet ausschließlich zu diesen AGB, entgegenstehende AGB oder Einkaufsbedingungen des Auftraggebers werden für das gegenständliche Rechtsgeschäft und die gesamte Geschäftsbeziehung hiermit ausdrücklich ausgeschlossen. Sie gelten auch dann nicht, wenn KÜGELE deren Anwendbarkeit nicht ausdrücklich widerspricht.

Diese AGB enthalten alle Vereinbarungen der Vertragsparteien über den Vertragsgegenstand und ersetzen allfällige frühere zwischen den Vertragsparteien getroffenen Vereinbarungen. Mündliche Nebenabreden zwischen den Vertragsparteien gelten als nicht getroffen, nachträgliche Änderungen oder Ergänzungen bedürfen der Schriftform. Der mündliche Verzicht auf die Schriftform wird einvernehmlich ausgeschlossen. Sollte eine Bestimmung dieser AGB ganz oder teilweise unwirksam oder undurchführbar sein oder werden, berührt dies nicht die Rechtswirksamkeit oder Durchführbarkeit der übrigen Bestimmungen. Die unwirksame oder undurchführbare Bestimmung wird durch eine wirksame oder durchführbare Bestimmung ersetzt, wie es dem im Vertrag zum Ausdruck gekommenen Zweck am besten entspricht, ohne daß eine der Vertragsparteien unverhältnismäßig benachteiligt wird. Dasselbe gilt analog für Lücken.

Der Kunde darf mit eigenen Forderungen gegen Forderung von KÜGELE nicht aufrechnen. Der Kunde darf geschuldete Beträge nicht zurückbehalten. Vertreter und selbständige Handelsvertreter der KÜGELE sind nicht berechtigt, Verträge abzuschließen bzw. Vertragsänderungen vorzunehmen oder Sonderkonditionen zu vereinbaren. Mit der Abgabe eines Auftrags stellt der Kunde ein verbindliches und unwiderrufliches Angebot an die KÜGELE zum Erwerb des Produktes. Der Kunde ist an seinen Auftrag 21 Tage ab Einlangen bei der KÜGELE gebunden.

2. Preise:

Die von KÜGELE zur Verfügung gestellten Preislisten in Euro sind unverbindlich empfohlene Verkaufspreislisten inklusive Mehrwertsteuer. Sollte die Auslieferung einer Bestellung für einen späteren Zeitpunkt gewünscht werden, so ist dies mit KÜGELE ausdrücklich und schriftlich zu vereinbaren, andernfalls gelten die Preise am Auslieferungstag. Die Preise basieren auf den jeweils gültigen Rohstoff bzw. Materialpreisen. Sollte sich hierbei eine Änderung ergeben, so behält sich KÜGELE vor, diese Preise an den Kunden weiter zu geben.

3. Lieferung:

Die angegebenen Lieferzeiten sind, sofern nicht schriftlich ein Fixgeschäft vereinbart worden ist, nur annähernde Angaben. Der Kunde ist bei unwesentlichen Verspätungen nicht berechtigt, vom Vertrag zurück zu treten. Reklamationen aufgrund Beschädigungen können nur anerkannt werden, wenn die Art der Beschädigung bei Übernahme auf dem Frachtbrief vermerkt wird. Die Lieferungen erfolgen auf Rechnung und Gefahr des Auftraggebers, und zwar ausschließlich zu den angeführten Bedingungen.

4. Zahlung:

Sämtliche Zahlungen sind nach Rechnungslegung ohne jeden Abzug spesenfrei fällig, sofern nicht schriftlich etwas anderes vereinbart ist. Der Auftraggeber ist nicht berechtigt, Zahlungen aufgrund von Teillieferungen oder Bemängelungen zurück zu halten. Befindet sich der Kunde in Zahlungsverzug, so werden vorbehaltlich der Geltendmachung eines darüber hinausgehenden Verzugschadens Zinsen in Höhe von 1 % per Monat des in Verzug befindlichen Betrags in Rechnung gestellt. Der Kunde verpflichtet sich, für den Fall des Verzuges, die der KÜGELE entstehenden Mahn- und Inkassospesen zu ersetzen. Jedenfalls ist ein Skontoabzug unzulässig, soweit Kaufpreisforderungen aufgrund älterer fälliger Rechnungen noch unbeglichen sind.

5. Auftragsbearbeitung, Verpackung und Fracht:

Die Standardlänge der ausgelieferten Profile beträgt 270 cm und 100 cm bei Einzelstangen und werden mit weiteren 10 % Einzelstangenzuschlag verrechnet. Die Preise verstehen sich jeweils ohne Einlagestreifen. Die Preise verstehen sich exklusive Selbstklebeausrüstung.

Für Profile, die grundsätzlich ungebohrt angeboten werden, können auf ausdrücklichen Kundenwunsch Bohrungen durchgeführt werden, welche mit einem Zuschlag verrechnet werden.

Für Maßzuschnitte werden 25 % Schneidezuschlag auf den Stangenpreis in Rechnung gestellt. Die Schnitttoleranz beträgt +/- 3 mm. Die Rücknahme von Zuschnitten ist ausgeschlossen. Der bei Zuschnitten entstehende Verschnitt wird nur auf ausdrücklichen Wunsch mitgeliefert. Verpackung SB bzw. DIY.

Diesbezüglich bestehen eigene Preisspalten und verstehen sich die Verpackungseinheiten jeweils pro Profiltyp und Farbe. Profile sind schlauch- oder vakuumverpackt und mit einem Aufhänger mit Eurolochung versehen. Gebohrte Profile beinhalten die entsprechende Menge an Dübeln und Schrauben.

Grundsätzlich verstehen sich die Preise inklusive Verpackungskosten, ausgenommen bei Eigenaufmachung für Kunden. Fracht: Lieferungen in Österreich ab einem Betrag von EURO 200,- erfolgen frei Haus, ausgenommen hiervon sind Expresslieferungen. Lieferungen für den Exportbereich erfolgen ab Werk, sofern keine entsprechende schriftliche Vereinbarung besteht.

6. Stornierung:

Storn von Aufträgen oder Teilen von Aufträgen bedürfen der schriftlichen Genehmigung durch KÜGELE.

Der Kunde übernimmt die Kosten, welche im Zuge der Stornierung des Auftrags anfallen. Bei Sonderanfertigungen hinsichtlich Profiltyp und Zuschnitten sowie Sonderverpackungen ist ein Storno jedenfalls ausgeschlossen.

7. Retouren:

Retourwaren werden von der KÜGELE nur dann angenommen, wenn diese noch original-verpackt und unbeschädigt sind und die Rücknahme von KÜGELE schriftlich genehmigt wurde. Hierfür wird eine Manipulationsgebühr von 30 % des Warenwertes verrechnet. Die Frachtkosten für Retourwaren übernimmt der Kunde. Mindestbearbeitungsgebühr EURO 10,-

8. Produktänderungen:

KÜGELE ist berechtigt, Änderungen im Design, der Farbe und auch in den Maßen ihrer angebotenen Produkte vorzunehmen oder sie gänzlich aus dem Programm zu streichen. Kataloge, Broschüren, Prospekte und Muster bzw. Prototypen dienen nur der Illustration der Produkte und sind nicht verbindlich, was Qualität, Farbe und Ausführung betrifft. Mindestbearbeitungsgebühr EURO 10,-

9. Eigentumsrecht:

Die gelieferten Waren bleiben so lange im Eigentum der KÜGELE bis der Kunde alle Forderungen aus der Geschäftsverbindung bezahlt hat. Der Eigentumsvorbehalt an gelieferten Waren dient KÜGELE als Sicherheit für den kompletten offenen Kundensaldo und bezieht sich auch auf Kosten, die während des Geschäftsfalles aufgetreten sind, wie Fracht, Zinsen für allfällige Rechnungen, Beschädigung von Waren, etc.

Der Käufer tritt bereits jetzt die ihm aus dem Weiterverkauf gegen die Abnehmer zustehenden Kaufpreisforderungen an den Verkäufer ab, und zwar gleichgültig, ob die Vorbehaltsware ohne oder nach Verarbeitung und ob sie an einen oder mehrere Abnehmer verkauft wird.

Der Eigentumsvorbehalt gemäß den vorstehenden Vereinbarungen bleibt auch bestehen, wenn einzelne Forderungen des Verkäufers in eine laufende Rechnung aufgenommen werden und der Saldo gezogen oder anerkannt ist. Im Falle einer Verarbeitung der Waren bzw. Vermischen mit anderen Produkten erhält KÜGELE anteilmäßig das Eigentum an dem entstandenen Produkt. Nach Übernahme der Ware verpflichtet sich der Kunde, solange diese nicht in sein Eigentum übergegangen ist, die Ware sorgfältig und sicher zu verwahren und gegen Feuer, Wasser und Diebstahl zu versichern. Der Käufer ist verpflichtet, dem Verkäufer von Pfändungen der Waren oder der abgetretenen Forderungen durch Dritte oder von sonstigen Ansprüchen, die Dritte bezüglich der Waren erheben, unverzüglich schriftlich Mitteilung zu machen.

Der Käufer ist verpflichtet, dem Verkäufer jederzeit Zutritt zu den Geschäftsräumlichkeiten sowie zu den Lagern des Käufers zu gewähren und dem Verkäufer Waren im Ausmaß der offenen Forderungen auszuhandigen.

10. Schutzrecht - Sonderanfertigungen:

Wenn von KÜGELE Aufträge für Sonder- oder Kundenprofile in Auftrag genommen werden, garantiert der Besteller/Auftraggeber, dass das in Auftrag gegebene Profil nicht gegen ein bestehendes Patent, Gebrauchsmuster usw... verstößt. Werkzeugformen, die für solche Artikel hergestellt werden, bleiben geistiges Eigentum von KÜGELE, auch wenn der Besteller anteilige Herstellungskosten bezahlt. Ein Recht auf Herausgabe dieser Formen besteht nicht. Wenn vom Besteller innerhalb eines Jahres nach der letzten Lieferung keine weiteren Bestellungen eingehen, erlischt die Aufbewahrungspflicht.

Die Garantie für derartige Sonderanfertigungen umfasst auch die Schadloshaltung der KÜGELE gegen Ansprüche Dritter.

11. Gewährleistung und Haftung:

Der Kunde ist verpflichtet, die Ware ordnungsgemäß zu prüfen und einen allfälligen Mangel unverzüglich, spätestens 3 Tage nach Erhalt der Ware schriftlich geltend zu machen. Im Falle der Beanstandung ist der Kunde verpflichtet, die Ware sachgemäß zu lagern.

Die Beschreibung der KÜGELE-Produkte stellt keine Zusage einer bestimmten Eigenschaft oder eines bestimmten Wertes dar. Lieferung- und Leistungsverzögerungen aufgrund höherer Gewalt und aufgrund von Ereignissen, die KÜGELE die Leistung wesentlich erschweren oder unmöglich machen, insbesondere Streik, Aussperrung, behördliche Anordnungen, Ausfall oder Störung von Kommunikationsnetzen und Maschinen, usw., auch wenn sie bei Lieferanten oder Auftragsnehmern von KÜGELE oder deren Unterlieferanten oder Unterauftragsnehmern eintreten und bei Vertragsabschluss nicht vorhersehbar waren, hat KÜGELE auch bei verbindlich vereinbarten Fristen und Terminen nicht zu vertreten. Sie berechnen KÜGELE, die Lieferung bzw. Leistung um die Dauer der Behinderung hinauszuschieben.

Ein Schadenersatzanspruch ist - bei sonstigem Ausschluss - unverzüglich, längstens binnen einer Woche, nachdem der oder die Anspruchsberechtigten vom Schaden Kenntnis erlangt haben, schriftlich bei KÜGELE geltend zu machen. Diesfalls gilt die gesetzliche Verjährungsfrist für die gerichtliche Geltendmachung.

Aus dem Titel der Gewährleistung hat der Kunde bei behebbaren Mängeln lediglich Anspruch auf Verbesserung und Nachtrag des Fehlenden, wenn die Mängel bei der Leistungserbringung von KÜGELE zu vertreten sind. KÜGELE haftet für Vorsatz und grobe Fahrlässigkeit, für Verzug und Unmöglichkeit der Leistung nur, soweit diese durch sie zu vertreten sind, sowie für das Vorhandensein zugesicherter Eigenschaften. Die Haftung für leichte Fahrlässigkeit ist ausgeschlossen.

Der Ersatz von Folgeschäden und reinen Vermögensschäden, nicht erzielten Gewinnen oder Ersparnissen, Zinsverlusten oder von Schäden aus Ansprüchen Dritter gegen den Kunden ist im gesetzlich zulässigen Ausmaß ausgeschlossen. Die Beweislast für das Vorliegen grober Fahrlässigkeit obliegt dem Geschädigten.

12. Gerichtsstand und Rechtswahl:

Ausschließlicher Gerichtsstand für alle Streitigkeiten ist das für den ersten Wiener Gemeindebezirk sachlich zuständige Gericht. Auf alle Rechtsverhältnisse zwischen KÜGELE und den Kunden ist österreichisches Recht unter Ausschluss der Verweisungsnormen des Internationalen Privatrechts (IPRG) und unter Ausschluss der Bestimmungen des Übereinkommens der Vereinten Nationen über Verträge über den Internationalen Warenkauf (UNK) anwendbar.

Änderungen und Irrtümer vorbehalten!
Errors & omissions excepted!

Allgemeine Geschäftsbedingungen (AGB) der M.A. Kügele GmbH - im folgenden Kügele genannt:

1. Geltungsbereich:

Diese Allgemeinen Geschäftsbedingungen (AGB) finden Anwendung auf alle Rechtsgeschäfte, die zwischen Kügele und Kunden bzw. Lieferanten geschlossen werden und regeln die Erbringung und Durchführung aller derzeitigen und künftigen Leistungen und Lieferungen zwischen den Vertragsparteien. Kügele liefert und leistet ausschließlich zu diesen AGB, entgegenstehende AGB oder Einkaufsbedingungen des Auftraggebers werden für das gegenständliche Rechtsgeschäft und die gesamte Geschäftsbeziehung hiermit ausdrücklich ausgeschlossen. Sie gelten auch dann nicht, wenn Kügele deren Anwendbarkeit nicht ausdrücklich widerspricht.

Diese AGB enthalten alle Vereinbarungen der Vertragsparteien über den Vertragsgegenstand und ersetzen allfällige frühere zwischen den Vertragsparteien getroffenen Vereinbarungen. Mündliche Nebenabreden zwischen den Vertragsparteien gelten als nicht getroffen, nachträgliche Änderungen oder Ergänzungen bedürfen der Schriftform. Der mündliche Verzicht auf die Schriftform wird einvernehmlich ausgeschlossen. Sollte eine Bestimmung dieser AGB ganz oder teilweise unwirksam oder undurchführbar sein oder werden, berührt dies nicht die Rechtswirksamkeit oder Durchführbarkeit der übrigen Bestimmungen. Die unwirksame oder undurchführbare Bestimmung wird durch eine wirksame oder durchführbare Bestimmung ersetzt, wie es dem im Vertrag zum Ausdruck gekommenen Zweck am besten entspricht, ohne daß eine der Vertragsparteien unverhältnismäßig benachteiligt wird. Dasselbe gilt analog für Lücken.

Der Kunde darf mit eigenen Forderungen gegen Forderung von Kügele nicht aufrechnen. Der Kunde darf geschuldete Beträge nicht zurückbehalten. Vertreter und selbständige Handelsvertreter der Kügele sind nicht berechtigt, Verträge abzuschließen bzw. Vertragsänderungen vorzunehmen oder Sonderkonditionen zu vereinbaren. Mit der Abgabe eines Auftrags stellt der Kunde ein verbindliches und unwiderrufliches Angebot an die Kügele zum Erwerb des Produktes. Der Kunde ist an seinen Auftrag 21 Tage ab Einlangen bei der Kügele gebunden.

2. Preise:

Die von Kügele zur Verfügung gestellten Preislisten in Euro sind unverbindlich empfohlene Verkaufspreislisten inklusive Mehrwertsteuer. Sollte die Auslieferung einer Bestellung für einen späteren Zeitpunkt gewünscht werden, so ist dies mit Kügele ausdrücklich und schriftlich zu vereinbaren, andernfalls gelten die Preise am Auslieferungstag. Die Preise basieren auf den jeweils gültigen Rohstoff bzw. Materialpreisen. Sollte sich hierbei eine Änderung ergeben, so behält sich Kügele vor, diese Preise an den Kunden weiter zu geben.

3. Lieferung:

Die angegebenen Lieferzeiten sind, sofern nicht schriftlich ein Fixgeschäft vereinbart worden ist, nur annähernde Angaben. Der Kunde ist bei unwesentlichen Verspätungen nicht berechtigt, vom Vertrag zurück zu treten. Reklamationen aufgrund Beschädigungen können nur anerkannt werden, wenn die Art der Beschädigung bei Übernahme auf dem Frachtbrief vermerkt wird. Die Lieferungen erfolgen auf Rechnung und Gefahr des Auftraggebers, und zwar ausschließlich zu den angeführten Bedingungen.

4. Zahlung:

Sämtliche Zahlungen sind nach Rechnungslegung ohne jeden Abzug spesenfrei fällig, sofern nicht schriftlich etwas anderes vereinbart ist. Der Auftraggeber ist nicht berechtigt, Zahlungen aufgrund von Teillieferungen oder Bemängelungen zurück zu halten. Befindet sich der Kunde in Zahlungsverzug, so werden vorbehaltlich der Geltendmachung eines darüber hinausgehenden Verzugschadens Zinsen in Höhe von 1 % per Monat des in Verzug befindlichen Betrags in Rechnung gestellt. Der Kunde verpflichtet sich, für den Fall des Verzuges, die der Kügele entstehenden Mahn- und Inkassospesen zu ersetzen. Jedenfalls ist ein Skontoabzug unzulässig, soweit Kaufpreisforderungen aufgrund älterer fälliger Rechnungen noch unbeglichen sind.

5. Auftragsbearbeitung, Verpackung und Fracht:

Die Standardlänge der ausgelieferten Profile beträgt 270 cm und 100 cm bei Einzelstangen und werden mit weiteren 10 % Einzelstangenzuschlag verrechnet. Die Preise verstehen sich jeweils ohne Einlagestreifen. Die Preise verstehen sich exklusive Selbstklebeausrüstung.

Für Profile, die grundsätzlich ungebohrt angeboten werden, können auf ausdrücklichen Kundenwunsch Bohrungen durchgeführt werden, welche mit einem Zuschlag verrechnet werden.

Für Maßzuschnitte werden 25 % Schneidezuschlag auf den Stangenpreis in Rechnung gestellt. Die Schnitttoleranz beträgt +/- 3 mm. Die Rücknahme von Zuschnitten ist ausgeschlossen. Der bei Zuschnitten entstehende Verschnitt wird nur auf ausdrücklichen Wunsch mitgeliefert. Verpackung SB bzw. DIY.

Diesbezüglich bestehen eigene Preisspalten und verstehen sich die Verpackungseinheiten jeweils pro Profiltyp und Farbe. Profile sind schlauch- oder vakuumverpackt und mit einem Aufhänger mit Eurolochung versehen. Gebohrte Profile beinhalten die entsprechende Menge an Dübeln und Schrauben.

Grundsätzlich verstehen sich die Preise inklusive Verpackungskosten, ausgenommen bei Eigenaufmachung für Kunden. Fracht: Lieferungen in Deutschland ab einem Betrag von EURO 200,- erfolgen frei Haus, ausgenommen hiervon sind Expresslieferungen. Lieferungen für den Exportbereich erfolgen ab Werk, sofern keine entsprechende schriftliche Vereinbarung besteht.

6. Stornierung:

Storn von Aufträgen oder Teilen von Aufträgen bedürfen der schriftlichen Genehmigung durch Kügele.

Der Kunde übernimmt die Kosten, welche im Zuge der Stornierung des Auftrags anfallen. Bei Sonderanfertigungen hinsichtlich Profiltyp und Zuschnitten sowie Sonderverpackungen ist ein Storno jedenfalls ausgeschlossen.

7. Retouren:

Retourwaren werden von der Kügele nur dann angenommen, wenn diese noch original-verpackt und unbeschädigt sind und die Rücknahme von Kügele schriftlich genehmigt wurde. Hierfür wird eine Manipulationsgebühr von 30 % des Warenwertes verrechnet. Die Frachtkosten für Retourwaren übernimmt der Kunde. Mindestbearbeitungsgebühr EURO 10,-.

8. Produktänderungen:

Kügele ist berechtigt, Änderungen im Design, der Farbe und auch in den Maßen ihrer angebotenen Produkte vorzunehmen oder sie gänzlich aus dem Programm zu streichen. Kataloge, Broschüren, Prospekte und Muster bzw. Prototypen dienen nur der Illustration der Produkte und sind nicht verbindlich, was Qualität, Farbe und Ausführung betrifft. Mindestbearbeitungsgebühr EURO 10,-.

9. Eigentumsrecht:

Die gelieferten Waren bleiben so lange im Eigentum der Kügele bis der Kunde alle Forderungen aus der Geschäftsverbindung bezahlt hat. Der Eigentumsvorbehalt an gelieferten Waren dient Kügele als Sicherheit für den kompletten offenen Kundensaldo und bezieht sich auch auf Kosten, die während des Geschäftsfalles aufgetreten sind, wie Fracht, Zinsen für allfällige Rechnungen, Beschädigung von Waren, etc.

Der Käufer tritt bereits jetzt die ihm aus dem Weiterverkauf gegen die Abnehmer zustehenden Kaufpreisforderungen an den Verkäufer ab, und zwar gleichgültig, ob die Vorbehaltsware ohne oder nach Verarbeitung und ob sie an einen oder mehrere Abnehmer verkauft wird.

Der Eigentumsvorbehalt gemäß den vorstehenden Vereinbarungen bleibt auch bestehen, wenn einzelne Forderungen des Verkäufers in eine laufende Rechnung aufgenommen werden und der Saldo gezogen oder anerkannt ist. Im Falle einer Verarbeitung der Waren bzw. Vermischen mit anderen Produkten erhält Kügele anteilsmäßig das Eigentum an dem entstandenen Produkt. Nach Übernahme der Ware verpflichtet sich der Kunde, solange diese nicht in sein Eigentum übergegangen ist, die Ware sorgfältig und sicher zu verwahren und gegen Feuer, Wasser und Diebstahl zu versichern. Der Käufer ist verpflichtet, dem Verkäufer von Pfändungen der Waren oder der abgetretenen Forderungen durch Dritte oder von sonstigen Ansprüchen, die Dritte bezüglich der Waren erheben, unverzüglich schriftlich Mitteilung zu machen.

Der Käufer ist verpflichtet, dem Verkäufer jederzeit Zutritt zu den Geschäftsräumlichkeiten sowie zu den Lagern des Käufers zu gewähren und dem Verkäufer Waren im Ausmaß der offenen Forderungen auszuhandigen.

10. Schutzrecht - Sonderanfertigungen:

Wenn von Kügele Aufträge für Sonder- oder Kundenprofile in Auftrag genommen werden, garantiert der Besteller/Auftraggeber, dass das in Auftrag gegebene Profil nicht gegen ein bestehendes Patent, Gebrauchsmuster usw... verstößt. Werkzeugformen, die für solche Artikel hergestellt werden, bleiben geistiges Eigentum von Kügele, auch wenn der Besteller anteilige Herstellungskosten bezahlt. Ein Recht auf Herausgabe dieser Formen besteht nicht. Wenn vom Besteller innerhalb eines Jahres nach der letzten Lieferung keine weiteren Bestellungen eingehen, erlischt die Aufbewahrungspflicht.

Die Garantie für derartige Sonderanfertigungen umfasst auch die Schadloshaltung der Kügele gegen Ansprüche Dritter.

11. Gewährleistung und Haftung:

Der Kunde ist verpflichtet, die Ware ordnungsgemäß zu prüfen und einen allfälligen Mangel unverzüglich, spätestens 3 Tage nach Erhalt der Ware schriftlich geltend zu machen. Im Falle der Beanstandung ist der Kunde verpflichtet, die Ware sachgemäß zu lagern.

Die Beschreibung der Kügele-Produkte stellt keine Zusage einer bestimmten Eigenschaft oder eines bestimmten Wertes dar. Lieferung- und Leistungsverzögerungen aufgrund höherer Gewalt und aufgrund von Ereignissen, die Kügele die Leistung wesentlich erschweren oder unmöglich machen, insbesondere Streik, Aussperrung, behördliche Anordnungen, Ausfall oder Störung von Kommunikationsnetzen und Maschinen, usw., auch wenn sie bei Lieferanten oder Auftragsnehmern von Kügele oder deren Unterlieferanten oder Unterauftragsnehmern eintreten und bei Vertragsabschluss nicht vorhersehbar waren, hat Kügele auch bei verbindlich vereinbarten Fristen und Terminen nicht zu vertreten. Sie berechnen Kügele, die Lieferung bzw. Leistung um die Dauer der Behinderung hinauszuschieben.

Ein Schadenersatzanspruch ist - bei sonstigem Ausschluss - unverzüglich, längstens binnen einer Woche, nachdem der oder die Anspruchsberechtigten vom Schaden Kenntnis erlangt haben, schriftlich bei Kügele geltend zu machen. Diesfalls gilt die gesetzliche Verjährungsfrist für die gerichtliche Geltendmachung.

Aus dem Titel der Gewährleistung hat der Kunde bei behebbaren Mängeln lediglich Anspruch auf Verbesserung und Nachtrag des Fehlenden, wenn die Mängel bei der Leistungserbringung von Kügele zu vertreten sind. Kügele haftet für Vorsatz und grobe Fahrlässigkeit, für Verzug und Unmöglichkeit der Leistung nur, soweit diese durch sie zu vertreten sind, sowie für das Vorhandensein zugesicherter Eigenschaften. Die Haftung für leichte Fahrlässigkeit ist ausgeschlossen.

Der Ersatz von Folgeschäden und reinen Vermögensschäden, nicht erzielten Gewinnen oder Ersparnissen, Zinsverlusten oder von Schäden aus Ansprüchen Dritter gegen den Kunden ist im gesetzlich zulässigen Ausmaß ausgeschlossen. Die Beweislast für das Vorliegen grober Fahrlässigkeit obliegt dem Geschädigten.

12. Gerichtsstand und Rechtswahl:

Ausschließlicher Gerichtsstand für alle Streitigkeiten ist das für München sachlich zuständige Gericht. Auf alle Rechtsverhältnisse zwischen Kügele und den Kunden ist Deutsches Recht unter Ausschluss der Verweisungsnormen des Internationalen Privatrechtes (IPRG) und unter Ausschluss der Bestimmungen des Übereinkommens der Vereinten Nationen über Verträge über den Internationalen Warenkauf (UNK) anwendbar.

Änderungen und Irrtümer vorbehalten!
Errors & omissions excepted!



KÜGELE PROFILE GmbH

Industriezentrum NÖ SÜD

Strasse 10, Objekt 49

Sektor ROT

2355 Wr. Neudorf

FN 256402m

Handelsgericht Wien

Telefon : +43 (1) 601 79 - 0

Fax: + 43 (1) 601 79 – 70

office@kuegele.com

www.kuegele.com

KÜGELE DEUTSCHLAND

M. A. Kügele GmbH

D-85764 Oberschleißheim

Mittenheimer Strasse 66

HRB 205599

Amtsgericht München

Tel.: +49 (0) 89 - 37 55 999 4

Fax.: +49 (0) 89 - 37 55 9 666

schauraum@kuegele.de